

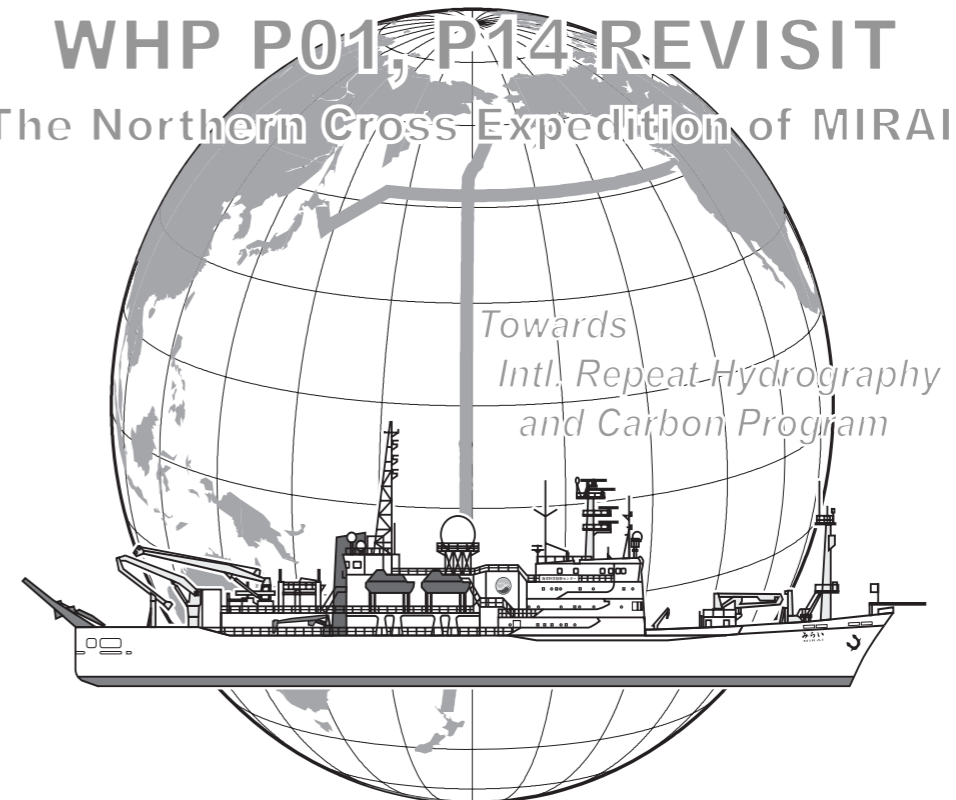

WHP P01, P14 REVISIT DATA BOOK

*Edited by
Takeshi Kawano (JAMSTEC),
Hiroshi Uchida (JAMSTEC)
Toshimasa Doi (JAMSTEC)*

WHP P01, P14 REVISIT
- The Northern Cross Expedition of MIRAI -



WHP P01, P14 REVISIT DATA BOOK

March,1, 2009 Published

Edited by Takeshi Kawano (JAMSTEC), Hiroshi Uchida (JAMSTEC) and Toshimasa Doi (JAMSTEC)

Published by © JAMSTEC, Yokosuka, Kanagawa, 2009
Japan Agency for Marine-Earth Science and Technology
2-15 Natsushima, Yokosuka, Kanagawa. 237-0061, Japan
Phone +81-46-867-9471, Fax +81-46-867-9455

Printed by Ryoin Co., Ltd.
12, Nishikichou, Naka-ward, Yokohama, 231-8715, Japan

Contents

Preface	iii
<i>M. Fukasawa (JAMSTEC)</i>		
Documents and .sum files		
1. Cruise Narrative	1
<i>T. Kawano (JAMSTEC)</i>		
2. Underway Measurements		
2.1 Navigation and Bathymetry	14
<i>T. Matsumoto (Univ. Ryukyus) et al.</i>		
2.2 Surface Meteorological Observation	19
<i>K. Yoneyama (JAMSTEC) et al.</i>		
2.3 Thermosalinograph and related measurements	23
<i>Y. Kumamoto (JAMSTEC) et al.</i>		
2.4 Underway pCO ₂	29
<i>A. Murata (JAMSTEC) et al.</i>		
2.5 Acoustic Doppler Current Profiler	31
<i>S. Kouketsu (JAMSTEC) et al.</i>		
2.6 XCTD	33
<i>H. Uchida (JAMSTEC) et al.</i>		
3. Hydrographic Measurement Techniques and Calibrations		
3.1 CTD/O ₂ Measurements	36
<i>H. Uchida (JAMSTEC) et al.</i>		
3.2 Salinity	62
<i>T. Kawano (JAMSTEC) et al.</i>		
3.3 Oxygen	67
<i>Y. Kumamoto (JAMSTEC) et al.</i>		
3.4 Nutrients	76
<i>M. Aoyama (MRI/JMA) et al.</i>		
3.5 Dissolved inorganic carbon (C _T)	90
<i>A. Murata (JAMSTEC) et al.</i>		
3.6 Total Alkalinity	94
<i>A. Murata (JAMSTEC) et al.</i>		
3.7 pH	97
<i>A. Murata (JAMSTEC) et al.</i>		
3.8 CFCs	100
<i>K. Sasaki (JAMSTEC) et al.</i>		
3.9 Lowered Acoustic Doppler Current Profiler	102
<i>S. Kouketsu (JAMSTEC) et al.</i>		

Station Summary

<i>49MR0704_1.sum file</i>	105
<i>49MR0706_1.sum file</i>	116
<i>49MR0706_2.sum file</i>	130

Figures

<i>Figure captions</i>	142
<i>Station locations</i>	144
<i>Bathymetry</i>	146
<i>Surface wind</i>	160
<i>Sea surface temperature</i>	162
<i>Sea surface salinity</i>	164
<i>ΔpCO₂</i>	166
<i>Surface current</i>	168
Cross-sections		
<i>Potential temperature</i>	170
<i>Salinity</i>	172
<i>Salinity (with SSW correction)</i>	174
<i>Density (σ_θ)</i>	176
<i>Density (σ₄)</i>	178
<i>Neutral density (γⁿ)</i>	180
<i>Oxygen</i>	182
<i>Silicate</i>	184
<i>Nitrate</i>	186
<i>Nitrite</i>	188
<i>Phosphate</i>	190
<i>Dissolved inorganic carbon</i>	192
<i>Total alkalinity</i>	194
<i>pH</i>	196
<i>CFC-11</i>	198
<i>CFC-12</i>	200
<i>CFC-12</i>	202
<i>Velocity</i>	204
Difference between WOCE and the revisit		
<i>Potential temperature</i>	206
<i>Salinity (with SSW correction)</i>	208
<i>Oxygen</i>	210
.sum, .sea, .wct and other data files		<i>CD-ROM on the back cover</i>

Preface

We, Ocean General Circulation Observational Research Program of IORGC (Institute of Observational Research for Global Change), published four data books after WHP (World Ocean Circulation Experiment Hydrographic Program) revisits along P17N, P6, A10, I3/I4, P3, P10, so far. It is our great pleasure that quite a few scientists in the world accepted our activities not only as references for their scientific works but also even as text books for education.

In 2007, we carried out two cruises on R/V Mirai of JAMSTEC (Japan Agency for Marine Earth Science and Technology) as “The Northern Cross Expedition of Mirai” in order to complete our interim research plan for the period from 2004 through 2008. Target of the cruises was to re-occupy WHP-P1 and WHP-P14 lines.

WHP-P1 is the line occupied in 1985 by United States (Chief Scientist was Dr. Talley) and is the first WHP line that the quality of provided data almost the WOCE standard from the re-occupation by Japan in 1999. Through the re-occupation of WHP-P1, the warming of bottom waters in the North Pacific Sub-arctic was detected and a new view point of changes in the meridional overturn was introduced. This re-occupation of WHP-P1 succeeded in demonstrating the fact that a re-occupation of a WHP line with as high data quality as WOCE standard was so powerful to promote studies on climatic changes in the ocean especially in the deeper layer.

The third time re-occupation of WHP-P1, which is highlighted in this book, has objectives not only for confirming the bottom water warming. It is to detect Bio-Geochemical changes in the North Pacific Sub-arctic gyre because as far as carbon items concern, this cruise can be regarded as the second time re-occupation. Bio-Geochemical time series stations of K1(Japan) and P(Canada) are located in the western and the eastern ends of WHP-P1, respectively. Of these stations, K1 was established after the second time re-occupation of WHP-P1. Amount of new knowledge are expected to be brought through a comprehensive analysis of data from the WHP re-occupation and from time series stations.

WHP-P14 is the line along the meridian of 175°E. This line was occupied during 1992 though 1996 by three cruises of P14C, P14N and P14S (Chief Scientists were Drs. Roden, Roemmich and Bullister, respectively). This line was selected to be re-occupied as the last long hydrographic ocean observation of the interim research plan of Ocean General Circulation Observational Research Program of IORGC because of two main reasons. The first one is to prepare

new data sets of carbon items and of Freons in the center of the Pacific together with other data sets to bound the eastern extension of the bottom water warming. The second one is on rather long history. Japan Meteorological Agency has been declared to re-occupy WHP-P13 along 165°E since 2002 with the same data quality as of WOCE standard. The re-occupation of WHP-P13 was expected but it did not come true yet. On the other hand, the needs for hydrographic high quality data sets have become larger for the ocean climate research in the center of the Pacific. So, we decided to re-occupy WHP-P14, which is located close to WHP-P13, without interrupting the plan of Japan Meteorological Agency, though possible re-occupation of any zonal WHP line was more appropriate for us to estimate the meridional heat, sea water and material transports.

Finally, we would like to express our gratitude to all participants and crews of the R/V Mirai of the Japan Agency for Marine-earth Science and Technology, for their assistance in carrying out these cruises. The research system of JAMSTEC will be reformed largely in the fiscal year of 2009, however, we would like to continue our effort to re-occupy WHP lines with a vision of realizing a reliable prediction of global climate change. Data from those observations will be disseminated through our data book and web-sites of IORGC (<http://www.jamstec.go.jp/iorgc/ocorp/data/post-wace.html>), JAMSTEC(http://www.jamstec.go.jp/mirai/index_eng.html), IRHCP(International Repeat Hydrography and Carbon Project; <http://cchdo.ucsd.edu/index.html>), and CDIAC (Carbon Dioxide Information Analysis Center; http://cdiac.ornl.gov/oceans/RepeatSections/repeat_map.html). No permission is required to reproduce our data books and CDs. We only would like to ask a favor of all scientists to refer our data book of repeat hydrography as often as possible because such references prove that our efforts help the science not only of ourselves but also of all oceanographers and can make our activities for repeat hydrography sustainable.

On International Day of Disabled Persons at Yokosuka

Masao Fukasawa

Director-General, IORGC/JAMSTEC

Program Director, Ocean General Circulation Observational Research Program of IORGC/JAMSTEC

1 Cruise Narrative

1.1 Highlight

Cruise Code : MR07-04 and MR07-06

GHPO Section designation: P01 and P14

Chief Scientist: Takeshi Kawano (MR07-04 and MR07-06 Leg.1)
kawnaot@jamstec.go.jp
Akihiko Murata (MR07-06 Leg.2)
akihiko.murata@jamstec.go.jp

Ocean General Circulation Observational Research Program
Institute of Observational Research for Global Change
Japan Agency for Marine-earth Science and Technology
2-15, Natsushima, Yokosuka, Japan 237-0061
Fax: +81-46-867-9455

Ship: R/V MIRAI

Ports of Call:

MR07-04	Sekinehama – Hachinohe – Dutch Harbor
MR07-06 Leg.1	Sekinehama – Hachinohe – Majuro
MR07-06 Leg.2	Majuro – Auckland

Cruise Date:

MR07-04	July 24, 2007 – September 3, 2007
MR07-06 Leg.1	October 8, 2007 – November 20, 2007
MR07-06 Leg.2	November 22, 2007 – December 26, 2007

Number of Stations:

MR07-04	88 stations
MR07-06 Leg.1	143 stations
MR07-06 Leg.2	129 stations

Geographic boundaries:

MR07-04	145°27.26' E – 124°58.91' W 47°01.87' N – 39°41.32' N
MR07-06	152°05.43' E – 173°59.67' W 59°00.11' N – 35°38.06' S

Floats and drifters deployed:

MR07-04	5 floats
MR07-06	14 floats

Mooring deployed or recovered mooring: NONE

1.2 Cruise Summary

(1) Station occupied

MR07-04

A total of 88 stations was occupied using a Sea Bird Electronics 36 position carousel equipped with 12 liter Niskin X water sample bottles, a SBE911plus equipped with SBE35 deep ocean standards thermometer, SBE43 oxygen sensor, AANDERAA “optode” oxygen sensor and Benthos Inc. Altimeter and RDI Monitor ADCP. XCTDs were deployed at 18 stations. Cruise track and station location are shown in Figure 1.2.1(a).

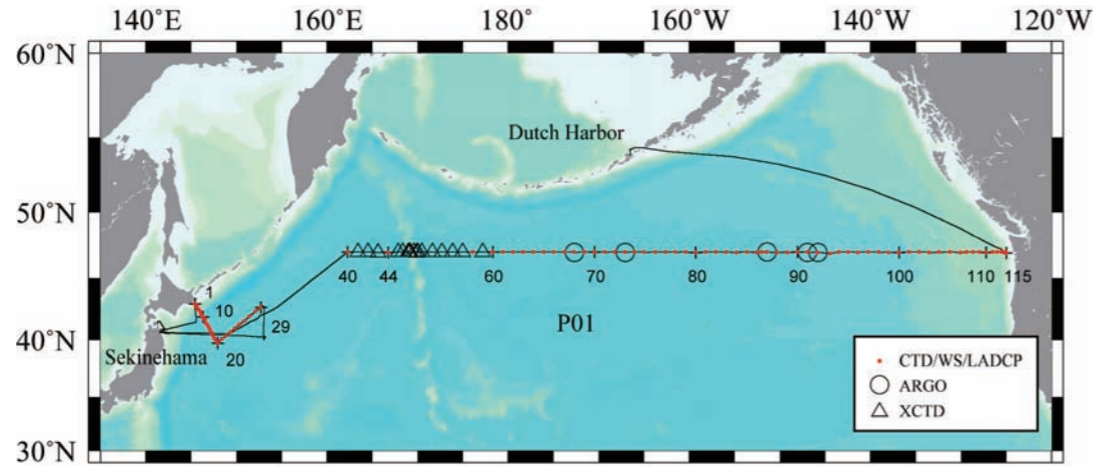

Fig.1.2.1 (a) Cruise Track and hydrographic stations. Solid circle (●) and Triangle (△) represents CTD station and XCTD station, respectively. Open circle (○) shows a position where ARGO floats were deployed.

MR07-06

A total of 272 stations (143 for Leg.1 and 129 for Leg.2) was occupied using a Sea Bird Electronics 36 position carousel equipped with 12 liter Niskin X water sample bottles, a SBE911plus equipped with SBE35 deep ocean standards thermometer, SBE43 oxygen sensor, AANDERAA “optode” oxygen sensor and Benthos Inc. Altimeter and RDI Monitor ADCP. Cruise track and station location are shown in Figure 1.2.1(b).

(2 Sampling and measurements)

Water samples were analyzed for salinity, oxygen, nutrients, CFC-11, -12, -113, total alkalinity, DIC, and pH. The sampling layers are coordinated as so-called staggered mesh. Samples for POM, ¹⁴C, ¹³C, ¹³⁷Cs, N₂O, CH₄ and DMS in MR07-04 and samples for POC, ¹⁴C, ¹³C, ¹³⁷Cs, Pu, Noble gases, stable isotopes of O₂ and a biological study in MR07-06 were also collected at the selected stations. The bottle depth diagram is shown in Figure 1.2.2. Underway measurements of pCO₂,

temperature, salinity, oxygen, surface current, bathymetry and meteorological parameters were conducted along the cruise track.

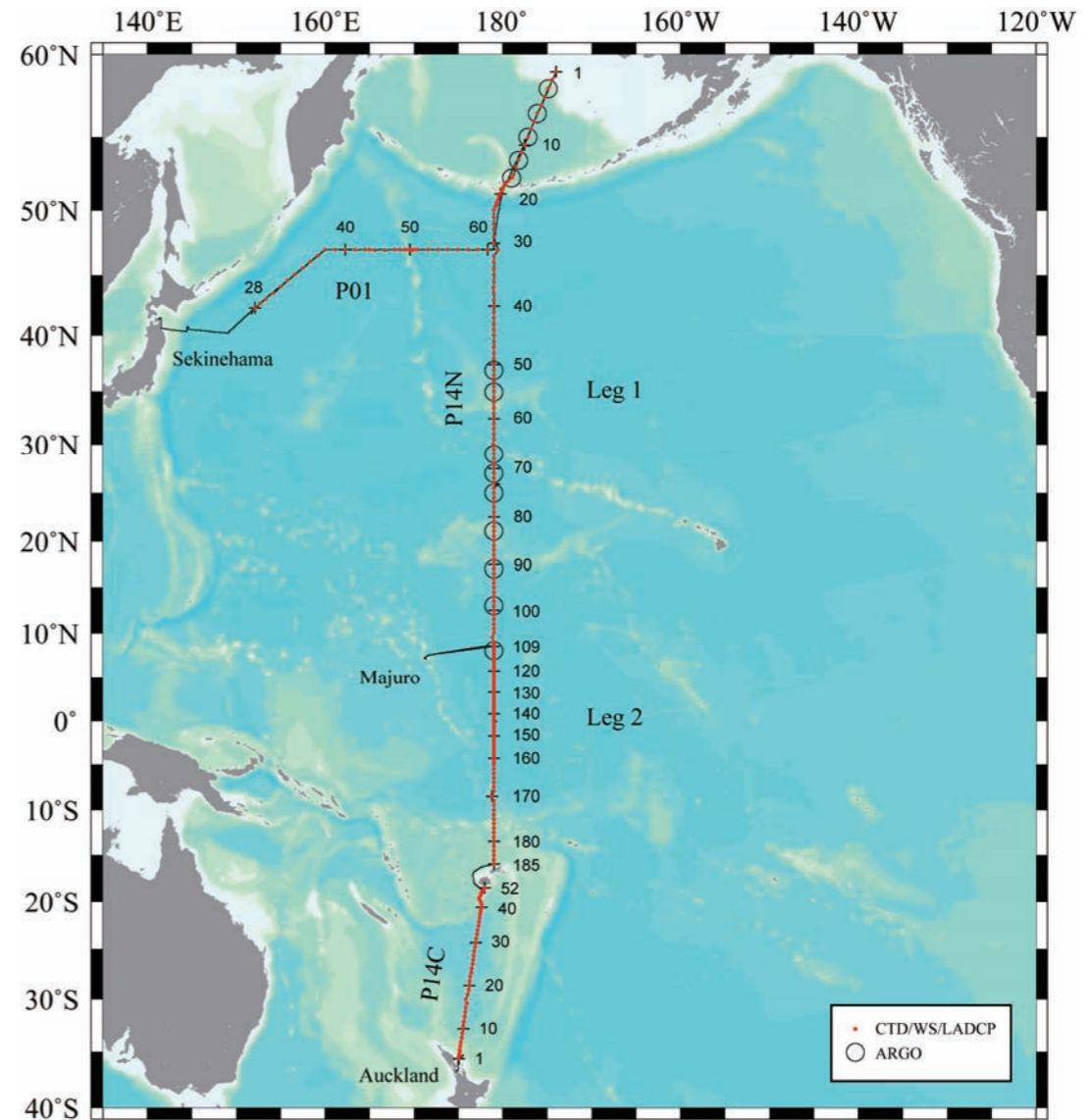

Fig.1.2.1 (b) Cruise Track and hydrographic stations. Solid circle (●) represents CTD station. Open circle (○) shows a position where ARGO floats were deployed.

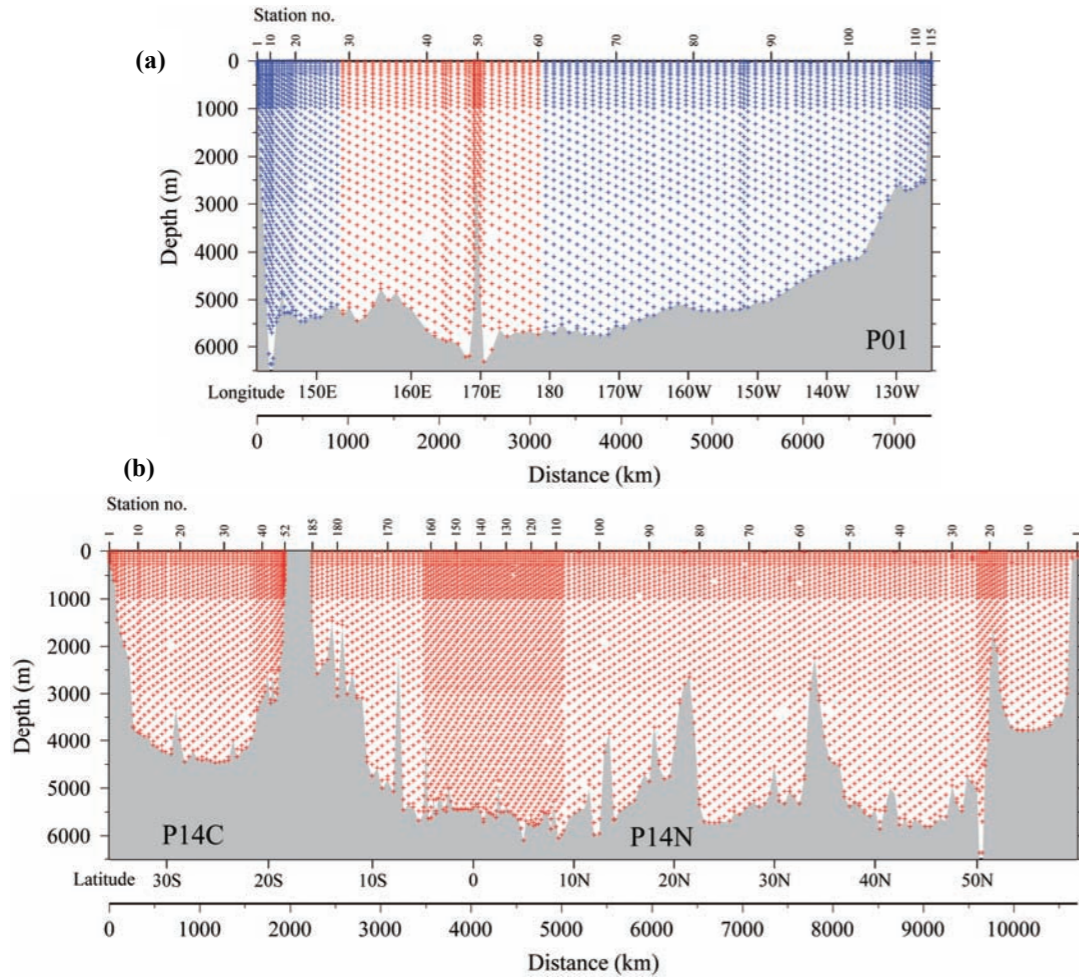

Fig. 1.2.2 The bottle depth diagram for (a) WHP-P1 and (b) WHP-P14. Blue cross (+) represents points where seawater was sampled in MR07-04 and red cross (+) represent points in MR07-06.

(4) Floats and Drifters deployed

ARGO floats were launched along the cruise track. The launched positions of the ARGO floats are listed in Table 1.2.1(a) and (b) for MR07-04 and MR07-06, respectively.

Table 1.2.1(a). Launched positions of the ARGO float in MR07-04.

Float S/N	ARGOS PTT ID	Date and Time of Reset (UTC)	Date and Time of Launch (UTC)	Location of Launch	St. No.
2811	66102	2007/8/16 23:53	2007/8/17 00:58	46-59.46 [N] 172-41.04[W]	P01-068
2804	66095	2007/8/18 09:48	2007/8/18 12:12	46-59.34 [N] 167-04.38[W]	P01-073
2352	60118	2007/8/22 23:55	2007/8/23 01:32	46-59.69 [N] 151-24.37[W]	P01-087
3050	70495	2007/8/24 01:49	2007/8/24 03:51	46-59.35 [N] 146-55.35[W]	P01-091
3049	70494	2007/8/24 08:13	2007/8/24 10:17	46-58.81 [N] 145-47.72[W]	P01-092

Table 1.2.1(b). Launched positions of the ARGO float in MR07-06

Float S/N	ARGOS PTT ID	Date and Time of Reset (UTC)	Date and Time of Launch (UTC)	Location of Launch	St. No.
3268	33318	2007/10/24 03:18	2007/10/24 04:34	52-16.13 [N] 178-58.20[W]	P14N-015
3264	33314	2007/10/24 17:44	2007/10/24 18:55	53-29.83 [N] 178-14.01[W]	P14N-012
3265	33315	2007/10/25 08:44	2007/10/25 10:18	54-59.59 [N] 177-09.45[W]	P14N-009
3260	33306	2007/10/26 00:41	2007/10/26 01:55	56-29.22 [N] 176-05.71[W]	P14N-006
3261	33307	2007/10/27 06:31	2007/10/27 08:01	57-59.70 [N] 174-53.87[W]	P14N-003
3331	75743	2007/11/04 07:05	2007/11/04 08:33	36-58.62 [N] 179-01.88[E]	P14N-051
3330	75742	2007/11/05 04:13	2007/11/05 05:56	34-59.89 [N] 178-59.80[E]	P14N-055
3329	75741	2007/11/07 21:25	2007/11/07 23:52	28-58.83 [N] 179-01.25[E]	P14N-067
3328	75740	2007/11/08 21:30	2007/11/09 00:21	26-59.79 [N] 179-01.77[E]	P14N-071
3341	75753	2007/11/11 04:43	2007/11/11 05:54	25-00.27 [N] 179-01.59[E]	P14N-075
3333	75745	2007/11/13 01:18	2007/11/13 02:28	21-00.66[N] 178-59.88[E]	P14N-083
3332	75744	2007/11/14 18:44	2007/11/14 21:36	17-01.42[N] 178-59.25[E]	P14N-091
3343	75755	2007/11/16 21:04	2007/11/16 21:59	13-00.39[N] 178-59.33[E]	P14N-099
3327	75739	2007/11/24 08:22	2007/11/24 10:05	08-00.17[N] 179-01.21[E]	P14N-111

(5) Moorings deployed or recovered

No mooring was deployed nor recovered during the cruise.

1.3 List of Principal Investigator and Person in Charge on the Ship

The principal investigator (PI) and the person in charge responsible for major parameters measured on the cruise are listed in Table 1.3.1.

Table 1.3.1(a) List of principal investigator and person in charge on the ship for MR07-04

Item	Principal Investigator	Person in Charge on the Ship
<i>Underway</i>		
ADCP	Shinya Kouketsu (JAMSTEC) skouketsu@jamstec.go.jp	Satoshi Okumura (GODI)
Bathymetry	Takeshi Matsumoto (Univ. Ryukyus) tak@sci.u-ryukyu.ac.jp	Satoshi Okumura (GODI)
Meteorology	Kunio Yoneyama (JAMSTEC) yoneyamak@jamstec.go.jp	Satoshi Okumura (GODI)
T-S	Yuichiro Kumamoto (JAMSTEC) kumamoto@jamstec.go.jp	Keisuke Wataki (MWJ)
pCO ₂	Akihiko Murata (JAMSTEC) akihiko.murata@jamstec.go.jp	Yoshiko Ishikawa, Yasuhiro Arie (MWJ)
<i>Hydrography</i>		
CTD/O ₂	Hiroshi Uchida (JAMSTEC) huchida@jamstec.go.jp	Satoshi Ozawa (MWJ)

LADCP	Shinya Kouketsu (JAMSTEC) skouketsu@jamstec.go.jp	Shinya Kouketsu (JAMSTEC)
Salinity	Takeshi Kawano (JAMSTEC) kawanot@jamstec.go.jp	Naoko Takahashi (MWJ)
Oxygen	Yuichiro Kumamoto (JAMSTEC) kumamoto@jamstec.go.jp	Kimiko Nishijima (MWJ)
Nutrients	Michio Aoyama (MRI) maoyama@mri-jma.go.jp	Ayumi Takeuchi (MWJ)
DIC	Akihiko Murata (JAMSTEC) akihiko.murata@jamstec.go.jp	Yoshiko Ishikawa, Yasuhiro Arie (MWJ)
Alkalinity	Akihiko Murata (JAMSTEC) akihiko.murata@jamstec.go.jp	Fuyuki Shibata, Minoru Kamata (MWJ)
pH	Akihiko Murata (JAMSTEC) akihiko.murata@jamstec.go.jp	Fuyuki Shibata, Minoru Kamata (MWJ)
CFCs	Kenichi Sasaki (JAMSTEC) ksasaki@jamstec.go.jp	Kenichi Sasaki (JAMSTEC)
Δ ¹⁴ C	Yuichiro Kumamoto (JAMSTEC) kumamoto@jamstec.go.jp	Yuichiro Kumamoto (JAMSTEC)
Radionuclides	Michio Aoyama (MRI) maoyama@mri-jma.go.jp	Junji Matsushita (MWJ)
N ₂ O & CH ₄	Naohiro Yoshida (TITECH) naoyoshi@depe.titech.ac.jp	Osamu Yoshida (Rakuno Gakuen Univ.)
XCTD	Hiroshi Uchida (JAMSTEC) huchida@jamstec.go.jp	Satoshi Okumura (GODI)
DMS	Ippei Nagao (Nagoya Univ.) i.nagao@nagoya-u.jp	Ippei Nagao (Nagiya Univ.)

PIM	Mitsuo Uematsu (ORI) uematsu@ori.u-tokyo.ac.jp	Yoko Iwamoto (ORI)
DOC	Masao Uchida (NIES) uchidama@nies.go.jp	Yukiko Kuroki (Univ. Tsukuba)
Floats, Drifters		
Argo float	Toshio Suga (JAMSTEC) sugat@jamstec.go.jp	Tomoyuki Takamori (MWJ)

GODI: Global Ocean Development Inc.

JAMSTEC: Japan Agency for Marine-Earth Science and Technology

MRI: Meteorological Research Institute, Japan Meteorological Agency

MWJ: Marine Works Japan, Ltd.

Nagoya Univ.: Nagoya University

NIES: National Institute for Environmental Studies

ORI: Ocean Research Institute, The University of Tokyo

Rakuno Gakuen Univ.: Rakuno Gakuen University

TITECH: Tokyo Institute of Technology

Univ. Tsukuba : University of Tsukuba

Univ. Ryukyus: University of the Ryukyus

Table 1.3.1(b) List of principal investigator and person in charge on the ship for MR07-06 Leg.1

Item	Principal Investigator	Person in Charge on the Ship
Underway		
ADCP	Shinya Kouketsu (JAMSTEC) skouketsu@jamstec.go.jp	Soichiro Sueyoshi (GODI)
Bathymetry	Takeshi Matsumoto (Univ. Ryukyus) tak@sci.u-ryukyu.ac.jp	Soichiro Sueyoshi (GODI)
Meteorology	Kunio Yoneyama (JAMSTEC) yoneyamak@jamstec.go.jp	Soichiro Sueyoshi (GODI)
T-S	Yuichiro Kumamoto (JAMSTEC) kumamoto@jamstec.go.jp	Masanori Enoki (MWJ)
pCO ₂	Akihiko Murata (JAMSTEC) akihiko.murata@jamstec.go.jp	Yoshiko Ishikawa (MWJ)
Hydrography		
CTD/O ₂	Hiroshi Uchida (JAMSTEC) huchida@jamstec.go.jp	Kenichi Katayama (MWJ)
LADCP	Shinya Kouketsu (JAMSTEC) skouketsu@jamstec.go.jp	Hiroshi Uchida (JAMSTEC)
Salinity	Takeshi Kawano (JAMSTEC) kawanot@jamstec.go.jp	Naoko Takahashi (MWJ)
Oxygen	Yuichiro Kumamoto (JAMSTEC) kumamoto@jamstec.go.jp	Kimiko Nishijima (MWJ)
Nutrients	Michio Aoyama (MRI) maoyama@mri-jma.go.jp	Ayumi Takeuchi (MWJ)
DIC	Akihiko Murata (JAMSTEC) akihiko.murata@jamstec.go.jp	Yoshiko Ishikawa (MWJ)

Alkalinity	Akihiko Murata (JAMSTEC) akihiko.murata@jamstec.go.jp	Ayaka Hatsuyama (MWJ)	Univ. Tokyo: The University of Tokyo Univ. Tsuluba : University of Tsukuba
pH	Akihiko Murata (JAMSTEC) akihiko.murata@jamstec.go.jp	Ayaka Hatsuyama (MWJ)	Univ. Ryukyus: University of the Ryukyus Univ, Washington: University of Washington
CFCs	Kenichi Sasaki (JAMSTEC) ksasaki@jamstec.go.jp	Kenichi Sasaki (JAMSTEC)	
$\Delta^{14}\text{C}$	Yuichiro Kumamoto (JAMSTEC) kumamoto@jamstec.go.jp	Yuichiro Kumamoto(JAMSTEC)	
Radionuclides	Michio Aoyama (MRI) maoyama@mri-jma.go.jp	Hideki Yamamoto (MWJ)	
Noble Gasses & $^{17}\text{O}/^{18}\text{O}$	Toshiro Saino (Nagoya Univ.) tsaino@ihas.nagoya-u.ac.jp	Charles Stump (Univ. Washington)	
Biology	Ken Furuya (Univ. Tokyo) furuya@fs.a.u-tokyo.ac.jp	Takuhei Shiozaki (Univ. Tokyo)	
DOC	Masao Uchida (NIES) uchidama@nies.go.jp	Chie Sato (Univ. Tsukuba)	
<i>Floats, Drifters</i>			
Argo float	Toshio Suga (JAMSTEC) sugat@jamstec.go.jp	Shinsuke Toyoda (MWJ)	

GODI: Global Ocean Development Inc.

JAMSTEC: Japan Agency for Marine-Earth Science and Technology

MRI: Meteorological Research Institute, Japan Meteorological Agency

MWJ: Marine Works Japan, Ltd.

Nagoya Univ.: Nagoya University

NIES: National Institute for Environmental Studies

Table 1.3.1(c) List of principal investigator and person in charge on the ship for MR07-06 Leg.2

Item	Principal Investigator	Person in Charge on the Ship
Underway		
ADCP	Shinya Kouketsu (JAMSTEC) skouketsu@jamstec.go.jp	Shinya Okumura (GODI)
Bathymetry	Takeshi Matsumoto (Univ. Ryukyus) tak@sci.u-ryukyu.ac.jp	Shinya Okumura (GODI)
Meteorology	Kunio Yoneyama (JAMSTEC) yoneyamak@jamstec.go.jp	Shinya Okumura (GODI)
T-S	Yuichiro Kumamoto (JAMSTEC) kumamoto@jamstec.go.jp	Masanori Enoki (MWJ)
pCO ₂	Akihiko Murata (JAMSTEC) akihiko.murata@jamstec.go.jp	Yoshiko Ishikawa (MWJ)
Hydrography		
CTD/O ₂	Hiroshi Uchida (JAMSTEC) huchida@jamstec.go.jp	Tomoyuki Takamori (MWJ)
LADCP	Shinya Kouketsu (JAMSTEC) skouketsu@jamstec.go.jp	Hiroshi Uchida (JAMSTEC)
Salinity	Takeshi Kawano (JAMSTEC) kawanot@jamstec.go.jp	Naoko Takahashi (MWJ)
Oxygen	Yuichiro Kumamoto (JAMSTEC) kumamoto@jamstec.go.jp	Kimiko Nishijima (MWJ)
Nutrients	Michio Aoyama (MRI) maoyama@mri-jma.go.jp	Kenichiro Sato (MWJ)
DIC	Akihiko Murata (JAMSTEC) akihiko.murata@jamstec.go.jp	Yoshiko Ishikawa (MWJ)

Alkalinity	Akihiko Murata (JAMSTEC) akihiko.murata@jamstec.go.jp	Minoru Kamata (MWJ)
pH	Akihiko Murata (JAMSTEC) akihiko.murata@jamstec.go.jp	Minoru Kamata (MWJ)
CFCs	Kenichi Sasaki (JAMSTEC) ksasaki@jamstec.go.jp	Kenichi Sasaki (JAMSTEC)
Δ ¹⁴ C	Yuichiro Kumamoto (JAMSTEC) kumamoto@jamstec.go.jp	Akihiko Murata (JAMSTEC)
Radionuclides	Michio Aoyama (MRI) maoyama@mri-jma.go.jp	Junji Matsushita (MWJ)
Biology	Ken Furuya (Univ. Tokyo) furuya@fs.a.u-tokyo.ac.jp	Takuhei Shiozaki (Univ. Tokyo)
DOC	Masao Uchida (NIES) uchidama@nies.go.jp	Yukiko Kuroki (Univ. Tsukuba)
Floats, Drifters		
Argo float	Toshio Suga (JAMSTEC) sugat@jamstec.go.jp	Tomoyuki Takamori (MWJ)

GODI: Global Ocean Development Inc.

JAMSTEC: Japan Agency for Marine-Earth Science and Technology

MRI: Meteorological Research Institute, Japan Meteorological Agency

MWJ: Marine Works Japan, Ltd.

NIES: National Institute for Environmental Studies

Univ. Tokyo: The University of Tokyo

Univ. Tsukuba : University of Tsukuba

Univ. Ryukyus: University of the Ryukyus

1.4 Scientific Program and Methods

(1) Nature and objectives of MR07-K04 and MR07-K06 cruise project

It is well known that the oceans play a central role in determining global climate. However heat and material transports in the ocean and their temporal changes have not yet been sufficiently quantified. Therefore, global climate change is not understood satisfactorily. The purposes of this research are to evaluate heat and material transports such as carbon, nutrients, etc. in the North Pacific and to detect their long term changes and basin-scale biogeochemical changes since the 1990s. The MR07-04 cruise is a reoccupation of the eastern part of the hydrographic section called 'WHP-P1', which was observed by an ocean science group of USA in 1985 as a part of WOCE (World Ocean Circulation Experiment) and by a joint group of Canada and Japan in 1999. MR07-06 is a reoccupation of the eastern part of WHP-P1 and the hydrographic section called 'WHP-P14', which was observed by an ocean science group of USA (United States of America) in 1993 also as a part of WOCE (World Ocean Circulation Experiment). The WOCE datasets are included in the data base of CLIVAR (Climate Variability and Predictability) and Carbon Hydrographic Data Office (<http://whpo.ucsd.edu/>). We will compare physical and chemical properties along section WHP-P1 and P14 with WOCE datasets to detect and evaluate long term changes of the marine environment in the Pacific Ocean.

Reoccupations of the WOCE hydrographic sections are now in progress by international cooperation in ocean science community, within the framework of CLIVAR, which is as part of World Climate Research Programme (WCRP) and IOCCP (International Ocean Carbon Coordination Project). Our research is planned as a contribution to these international projects supported by WMO, ICSU/SCOR and UNESCO/IOC, and its results and data will be published by 2009 for worldwide use.

The other purposes of this cruise are as follows:

- 1) to observe surface meteorological and hydrological parameters as a basic data of meteorology and oceanography such as studies on flux exchange, air-sea interaction and so on,
- 2) to observe sea bottom topography, gravity and magnetic fields along the cruise track to understand the dynamics of ocean plate and accompanying geophysical activities,

- 3) to observe bio-geochemical parameters to study carbon cycle in the ocean,

- 4) to observe green house gasses in the atmosphere and the ocean to study their cycle from bio-geochemical aspect.

(2) Cruise overview

MR07-04 was carried out during the period from July 24 to September 3, 2007. The cruise started from the coast near Hokkaido Japan, and sailed towards east along approximately 47°N. This line was called WHP-P1 and observed by an ocean science group of USA in 1985 as a part of WOCE (World Ocean Circulation Experiment) and by a joint group of Canada and Japan in 1999. The cruise had been designed as a re-occupation of the WHP-P1 stations; however, we could observe only the eastern half of the stations due to an accident. A number of observed stations was 88. MR07-06 cruise was carried out during the period from October 8, 2007 to December 26, 2007. The cruise started also from the coast near Hokkaido. The cruise was designed to observe the rest of WHP-P1 stations (the western part) and WHP-P14N and P14C. A number of stations was 272. At each station, full-depth CTD profile and up to 36 water samples were taken and analyzed. Water samples were obtained from surface to approximately 10 dbar above the bottom with 12-liter Niskin bottles attached to 36-position SBE carousel water sampler. Sampling layer is designed as so-called staggered mesh. The scientists of JAMSTEC and Meteorological Research Institute and the technicians of Marine Works Japan Ltd. (MWJ) were responsible for analyzing water sample for salinity, dissolved oxygen, nutrients, CFCs, total carbon contents, alkalinity, and pH. They also contributed to sampling for total organic carbon, radiocarbon and so on. The technicians of Global Ocean Development Inc. (GODI) had responsibility for a part of underway measurements such as current velocity by Acoustic Doppler Current Profiler (ADCP) geological parameters (topography, geo-magnetic field and gravity), and meteorological parameters. ARGO floats prepared by JAMSTEC and Institute of Ocean Sciences (Canada) were launched by MWJ technicians and the ship crew. The scientists of Tokyo Institute of Technology joined the cruise for their research on chemical oceanography. A scientist from University of the Ryukyus was a principal

investigator for geological parameters (topography, geo-magnetic field and gravity). The scientist from Ocean Research Institute, the university of Tokyo University, Nagoya University, Tsukuba University and University of Washington are also joined the cruise.

(3) Cruise narrative

MR07-04

R/V Mirai departed Hachinohe (Japan) on July 24, 2007. The hydrographic cast of CTD was started at the first station on July 26. All watchstanders were drilled in the method of sample drawing before the first station. Both propellers got entangled in a fishing net at the station 29 on August 2 (local time). Therefore we were forced to return to the port, Hachinohe, to cut and remove the fishing net. We spent 10 days for the trouble and it made us giving up our observation in the western part of the P1 line, from station 29 to station 60. We restarted the WHP revisit observation at the dateline, station P61. On the way from Hachinohe to station P61, we made a CTD cast specially designed for DMS, Nitrous oxide (N₂O), Methane (CH₄), Carbonyl sulfide (COS), and related substances at stations 40, 45, 58 and 60,. From stations 41 to 59 (except 45 and 58), we deploy XCTD (1,000m) instead of CTD cast. R/V Mirai arrived at Dutch Harbor (U.S.A.) on September 3, 2007.

MR07-06

R/V Mirai departed Hachinohe (Japan) on October 8, 2007. The hydrographic cast of CTD was started at the first station, station 28 of WHP-P1 on October 10. After observing the stations until P01-61, she turned to north to observe the stations of WHP-P14N. She called for Majuro (Republic of the Marshall Islands) on November 20, 2007 (Leg.1). She left Majuro on November 22, 2007 for Auckland (New Zealand) and arrived on December 26, 2007 (Leg.2). We observed 272 stations of a part of WHP-P01 line (47N), WHP-P14N and WHP-P14C.

1.5 Major Problems and Goals not Achieved

MR07-04

(1) Stations not occupied

Both propellers got entangled in a fishing net at the station 29. Therefore we were forced to return to the port, Hachinohe, to cut remove the fishing net. We spent 10 days for the trouble and it made us giving up our observation in the western part of the P1 line, from station 29 to station 60. We restarted the observation at the dateline, station P61.

At stations 40, 45, 58 and 60, we made a CTD cast specially designed for DMS, Nitrous oxide (N₂O), Methane (CH₄), Carbonyl sulfide (COS), and related substances.

From stations 41 to 59 (except 45 and 58), we deploy XCTD (1,000m) instead of CTD cast.

(2) Misfiring and mistrip

The carousel water sampler misfired at station 23 (bottle #15).

(3) CTD sensor replacement

We encountered to several problems (drift, shift, noise) of CTD sensors and replaced them after the following stations:

Sta. 10: primary conductivity sensor

Sta. 29: secondary temperature sensor

Sta. 44: primary temperature sensor

MR07-06

(1) Mistrip

The carousel water sampler mistripped at following stations;

Stn. P01-040 (Niskin Bottle #10)

Stn. P01-054 (Niskin Bottle #10)

Stn. P01-077 (Niskin Bottle #27)

Stn. P14N-054 (Niskin Bottle #11)

Stn. P14N-060 (Niskin Bottle #26)

Stn. P14N-063 (Niskin Bottle #11)
 Stn. P14N-064 (Niskin Bottle #11)
 Stn. P14N-071 (Niskin Bottle #31)
 Stn. P14N-092 (Niskin Bottle #24)
 Stn. P14N-099 (Niskin Bottle #18)
 Stn. P14N-101 (Niskin Bottle #16)
 Stn. P14N-103 (Niskin Bottle #5)
 Stn. P14N-107 (Niskin Bottle #3 and #12)

Stn. P14N-126(Niskin Bottle # 30)
 Stn.P14N-127(Niskin Bottle # 28)
 Stn. P14C-007(Niskin Bottle #22)

(2) CTD sensor replacement

We encountered to several problems (crack, drift, shift, noise) of CTD sensors and replaced them after the following stations:

Sta. P01_46: secondary conductivity sensor
 Sta. P14N_4: primary and secondary temperature sensors
 Sta. P14N_33: secondary temperature sensor
 Sta. P14N_51: secondary conductivity sensor
 Sta. P14N_74 cast 1: primary and secondary conductivity, and secondary temperature sensors*
 Sta. P14N_99: primary conductivity sensor
 Sta. P14N_108: primary conductivity sensor**
 Sta. P14N_171: secondary conductivity sensor

* without secondary temperature and conductivity sensors for Sta. P14N_74 cast 2, and secondary conductivity sensor for Stas. from P14N_75 to P14N_79.

** the broken primary conductivity sensor was replaced after the station P14N_109 cast 1.

(3)Thermosalinograph

Salinity data from 2007/10/30 3:36 to 2007/11/6 4:34 was lost due to stuffed antifouling devices.

1.6 List of Participants

The cruise participants of the cruises are listed in Table 1.3.2

Table 1.3.2(a) List of cruise participants for MR07-04

Name	Responsibility	Affiliation
Yasuhiro Arii	Carbon Items	MWJ
Miyo Ikeda	Dissolved Oxygen / Water Sampling	MWJ
Yoshiko Ishikawa	Carbon Items	MWJ
Yoko Iwamoto	Aerosol and Fog water	ORI
Minoru Kamata	Carbon Items	MWJ
Kenichi Katayama	CTD / Water Sampling	MWJ
Kaori Kawana	Aerosol and Fog water	ORI
Kohei Kawano	CH4 and N2O / Water Sampling	Tokyo Inst. Tech.
Takeshi Kawano	Chief Scientist / Salinity	IORGC/JAMSTEC
Kei Kojima	Water Sampling	MWJ
Chihiro Komatsu	Water Sampling	MWJ
Shinya Kouketsu	LADCP/ADCP / Water Sampling	IORGC/JAMSTEC
Yuichiro Kumamoto	DO / Thermosalinograph / Δ14C	IORGC/JAMSTEC

Yukiko Kuroki	Organic and Inorganic Carbon	University of Tsukuba	Shoko Tatamisashi	CFCs	MWJ
Takashi Makino	Water Sampling	MWJ	Hiroshi Uchida	CTD / LADCP / Water Sampling	IORGC/JAMSTEC
Junji Matsushita	Radionuclides / Water Sampling	MWJ	Hirokatsu Uno	CTD / Water Sampling	MWJ
Shunsuke Miyabe	Nutrients	MWJ	Keisuke Wataki	Dissolved Oxygen / Water Sampling	MWJ
Tomohiro Miyabukuro	CH ₄ and N ₂ O / Water Sampling	Tokyo Inst. Tech.	Osamu Yoshida	CH ₄ and N ₂ O / Water Sampling	Rakuno Gakuen University
Dai Motomura	Water Sampling	MWJ	GODI	Global Ocean Development Inc.	
Maki Mukai	Water Sampling	MWJ	IORGC	Institute of Observational Research for Global Change	
Akihiko Murata	Carbon Items/ Water sampling	IORGC/JAMSTEC	JAMSTEC	Japan Agency for Marine-earth Science and Technology	
Ippei Nagao	DMS	Nagoya University	MIO	Mutsu Institute of Oceanography	
Kimiko Nishijima	Dissolved Oxygen / Water Sampling	MWJ	MWJ	Marine Works Japan Ltd.	
Satoshi Okumura	Meteorology / Geophysics	GODI	ORI	Ocean Research Institute, The University of Tokyo	
Shinya Okumura	Meteorology / Geophysics	GODI	Tokyo Inst. Tech.	Tokyo Institute of Technology	
Ryo Oyama	Meteorology / Geophysics	GODI			
Satoshi Ozawa	Chief Technologist /CTD / Water Sampling	MWJ			
Katsunori Sagishima	CFCs	MWJ			
Kenichi Sasaki	CFCs	MIO/JAMSTEC			
Takayoshi Seike	Nutrients	MWJ			
Fuyuki Shibata	Carbon Items	MWJ			
Yuichi Sonoyama	CFCs	MWJ			
Kazuto Suzuki	Water Sampling	MWJ			
Naoko Takahashi	Salinity / Water Sampling	MWJ			
Tomoyuki Takamori	CTD / Water Sampling	MWJ			
Ayumi Takeuchi	Nutrients	MWJ			
Tatsuya Tanaka	Salinity / Water Sampling	MWJ			
Shigeki Tasaka	Radon	Gifu University			

Table 1.3.2(b) List of cruise participants for MR07-06 Leg.1

Name	Responsibility	Affiliation			
Yasuhiro Arii	Carbon	MWJ	Harumi Ota	Meteorology / Geophysics	GODI
Masanori Enoki	Dissolved Oxygen/Thermosalinograph	MWJ	Kentaro Oyama	CTD	MWJ
Hironobu Furuya	Biology	The University of Tokyo	Katsunori Sagishima	CFCs	MWJ
Ayaka Hatsuyama	Carbon	MWJ	Kenichi Sasaki	CFCs	MIO/JAMSTEC
Mana Hikami	Water Sampling	MWJ	Chie Sato	POC and Bacteria	University of Tsukuba
Miyo Ikeda	Dissolved Oxygen/Water Sampling	MWJ	Fuyuki Shibata	Chief Technologist/Carbon	MWJ
Yoichi Imai	Water Sampling	JMA	Takuhei Shiozaki	Biology	The University of Tokyo
Yoshiko Ishikawa	Carbon	MWJ	Charles Stump	Noble Gasses & ¹⁷ O/ ¹⁸ O	University of Washington
Kenichi Katayama	CTD	MWJ	Soichiro Sueyoshi	Meteorology / Geophysics	GODI
Yoshimi Kawai	LADCP/Water Sampling	IORGC/JAMSTEC	Takeshi Suzuki	Water Sampling	MWJ
Takeshi Kawano	Chief Scientist/Salinity/Water Sampling	IORGC/JAMSTEC	Naoko Takahashi	Salinity	MWJ
Fujio Kobayashi	Salinity	MWJ	Ayumi Takeuchi	Nutrients	MWJ
Taketoshi Kodama	Biology	The University of Tokyo	Shoko Tatamisashi	CFCs	MWJ
Fumiyoshi Kondo	Air-Sea Turbulent CO2 Flux	Okayama University	Shinsuke Toyoda	CTD/ARGO	MWJ
Yuichiro Kumamoto	Dissolved Oxygen/Water Sampling/ ¹⁴ C	IORGC/JAMSTEC	Hiroshi Uchida	CTD/LADCP/Water Sampling	IORGC/JAMSTEC
Nagi Masuda	Water Sampling	MWJ	Masahide Wakita	CFCs	MIO/JAMSTEC
Junji Matsushita	Nutrients	MWJ	Koshi Yamaguchi	Water Sampling	MWJ
Hiroshi Matsunaga	CTD	MWJ	Hideki Yamamoto	Radionuclides/Water Sampling	MWJ
Kohei Miura	Nutrients	MWJ	Kazuo Yamamoto	Water Sampling	MWJ
Takumi Miyahara	Water Sampling	MWJ		GODI	Global Ocean Development Inc.
Dai Motomura	Water Sampling	MWJ		IORGC	Institute of Observational Research for Global Change
Nguyen Van Nguyen	Biology	The University of Tokyo		JAMSTEC	Japan Agency for Marine-earth Science and Technology
Kimiko Nishijima	Dissolved Oxygen/Water Sampling	MWJ		JMA	Japan Meteorological Agency
Satoshi Okumura	Meteorology / Geophysics	GODI		MIO	Mutsu Institute of Oceanography
				MWJ	Marine Works Japan Ltd.

Table 1.3.2(b) List of cruise participants for MR07-06 Leg.2

Name	Responsibility	Affiliation			
Toshimasa Doi	LADCP/Water Sampling	IORGC/JAMSTEC	Shinya Okumura	Meteorology / Geophysics	GODI
Masanori Enoki	Dissolved Oxygen/Thermosalinograph	MWJ	Ryo Oyama	Meteorology / Geophysics	GODI
Tsutomu Fujii	CTD	MWJ	Satoshi Ozawa	Chief Technologist/CTD	MWJ
Hironobu Furuya	Biology	The University of Tokyo	Katsunori Sagishima	CFCs	MWJ
Ayaka Hatsuyama	Carbon	MWJ	Kenichi Sasaki	CFCs	MIO/JAMSTEC
Yukiko Hayakawa	Dissolved Oxygen/Water Sampling	MWJ	Kenichiro Sato	Nutrients	MWJ
Yoichi Imai	Water Sampling	JMA	Takayoshi Seike	Nutrients	MWJ
Yoshiko Ishikawa	Carbon	MWJ	Takuhei Shiozaki	Biology	The University of Tokyo
Ryota Ito	Water Sampling	MWJ	Yuichi Sonoyama	CFCs	MWJ
Minoru Kamata	Carbon	MWJ	Naoko Takahashi	Salinity	MWJ
Katsuro Katsumata	LADCP/Water Sampling	IORGC/JAMSTEC	Shoko Tatamisashi	CFCs	MWJ
Mikio Kitada	Carbon	MWJ	Tomoyuki Takamori	CTD/ARGO	MWJ
Taketoshi Kodama	Biology	The University of Tokyo	Tatsuya Tanaka	Salinity	MWJ
Misato Koide	Water Sampling	MWJ	Hiroshi Uchida	CTD/LADCP/Water Sampling	IORGC/JAMSTEC
Atsushi Kubo	Water Sampling	MWJ	Hirokatsu Uno	CTD	MWJ
Yukiko Kuroki	POC	University of Tsukuba	Kazuho Yoshida	Meteorology / Geophysics	GODI
Junji Matsushita	Radionuclides/Water Sampling	MWJ		GODI	Global Ocean Development Inc.
Kohei Miura	Nutrients	MWJ		IORGC	Institute of Observational Research for Global Change
Akihiko Murata	Chief Scientist/Carbon/Water Sampling	IORGC/JAMSTEC		JAMSTEC	Japan Agency for Marine-earth Science and Technology
Nguyen Van Nguyen	Biology	The University of Tokyo		JMA	Japan Meteorological Agency
Kimiko Nishijima	Dissolved Oxygen/Thermosalinograph	MWJ		MIO	Mutsu Institute of Oceanography
Haruka Nishimura	Water Sampling	MWJ		MWJ	Marine Works Japan Ltd.
Ayumi Nomura	Water Sampling	MWJ			
Takanori Ojima	Water Sampling	MWJ			

2. Underway Measurement

2.1 Navigation and Batymetry

2.1.1 Navigation

(1) Personnel

Souichiro Sueyoshi	(GODI)
Satoshi Okumura	(GODI)
Shinya Okumura	(GODI)
Kazuho Yoshida	(GODI)
Harumi Ota	(GODI)
Ryo Ohyama	(GODI)

(2) Overview of the equipment

Ship's position, speed and course were provided by Radio Navigation System on R/V MIRAI. The system integrates GPS position, Log speed, Gyro heading and other basic data on workstation. Ship's course and speed over ground are calculated from GPS position. The workstation clock is synchronized to reference clock by using NTP (Network Time Protocol). Navigation data, called as "SOJ data", is distributed to client computer every second, and recorded every 60 seconds.

Navigation devices are listed below.

1. GPS receiver (2sets): Trimble DS-4000 9-channel receiver, these antennas are located on Navigation deck, port and starboard side. GPS position from each receiver is converted to the position of radar mast.
2. Doppler log: Furuno DS-30, which use three acoustic beam for current measurement
3. Gyrocompass: Tokimec TG-6000, sperry mechanical gyrocompass
4. Reference clock: Symmetricom TymServ2100, GPS time server
5. Workstation Hewlett-Packard ZX2000 running HP-UX ver.11.22

(3) Data period

MR07-04:07:00, 24 July 2007 to 17:30, 3 September 2007 (UTC)

MR07-06 Leg1: 21:30, 7 October 2007 to 21:10, 20 November 2007 (UTC)

MR07-06 Leg2: 22:00, 21 November 2007 to 19:10, 25 December 2007 (UTC)

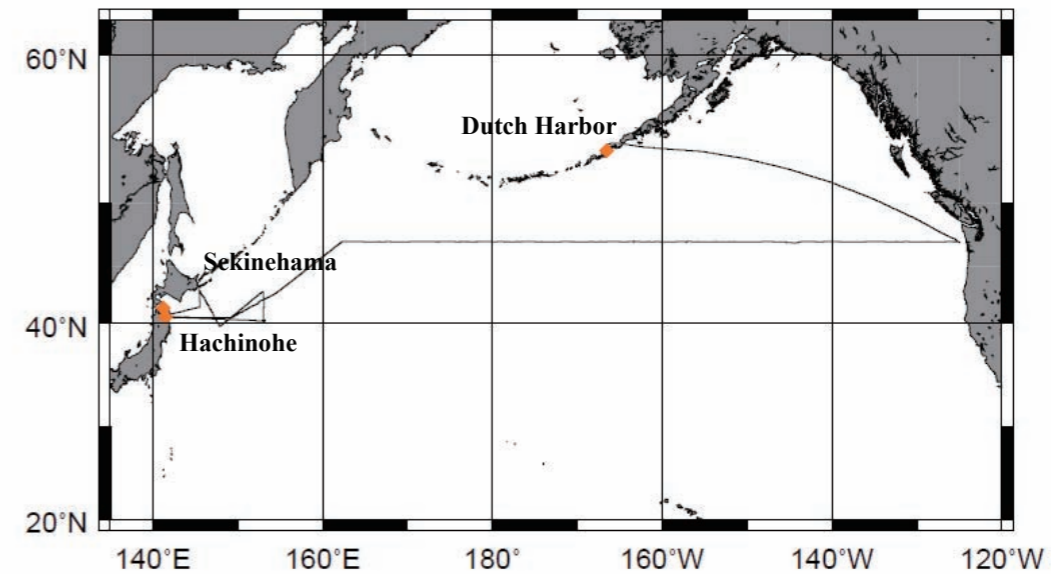

Figure 2.2.1-1 Cruise Track of MR07-04

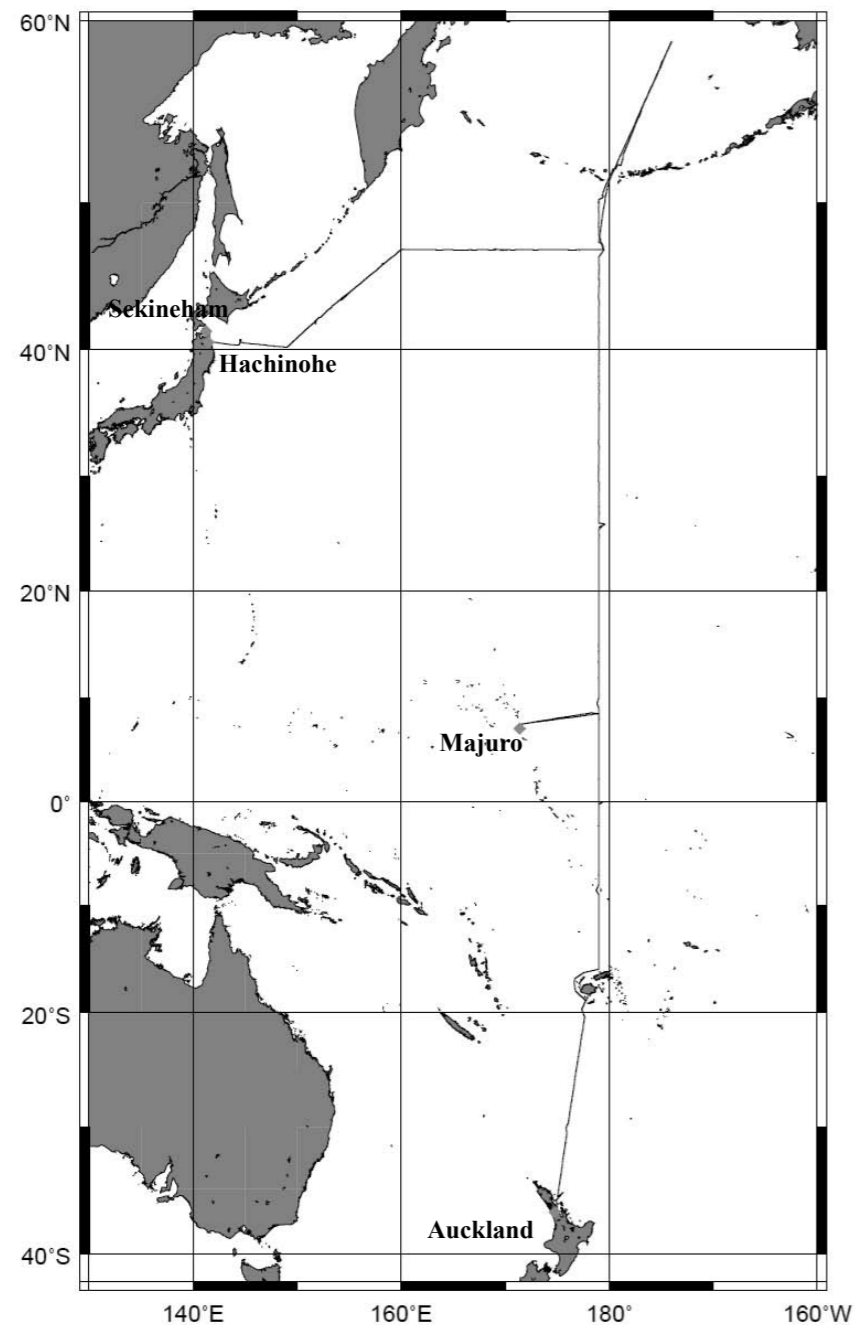

Figure 2.2.1-2 Cruise Track of MR07-06

2.1.2 Bathymetry

(1) Personnel

Takeshi Matsumoto (University of the Ryukyus)

Principal Investigator / Not on-board:

Souichiro Sueyoshi (GODI)

Satoshi Okumura (GODI)

Shinya Okumura (GODI)

Kazuho Yoshida (GODI)

Harumi Ota (GODI)

Ryo Ohyama (GODI)

(2) Overview of the equipments

R/V MIRAI equipped a Multi Beam Echo Sounding system (MBES), SEABEAM 2112.004 (SeaBeam Instruments Inc.) The main objective of MBES survey is collecting continuous bathymetry data along ship's track to make a contribution to geological and geophysical investigations and global datasets. Data interval along ship's track was max 17 seconds at 6,000 m. To get accurate sound velocity of water column for ray-path correction of acoustic multibeam, we used Surface Sound Velocimeter (SSV) data measured at the surface (6.2m depth), and the others depth sound velocity was calculated using temperature and salinity profiles from the nearest CTD data by the equation in Mackenzie (1981).

System configuration and performance of SEABEAM 2112.004,

Frequency:	12 kHz
Transmit beam width:	2 degree
Transmit power:	20 kW
Transmit pulse length:	3 to 20 msec.
Depth range:	100 to 11,000 m

Beam spacing:	1 degree athwart ship
Swath width:	150 degree (max)
	120 degree to 4,500 m
	100 degree to 6,000 m
	90 degree to 11,000 m
Depth accuracy:	Within < 0.5% of depth or +/-1m, whichever is greater, over the entire swath.

(Nadir beam has greater accuracy; typically within < 0.2% of depth or +/-1m, whichever is greater)

(3) Data Period

Bathymetric survey was carried out the CTD observation line during the cruise

MR07-04:	P01-001 on 26 July 2007 to P01-115 on 29 August. 2007
MR07-06 Leg1:	P01-028 on 10 October 2007 to P01-61 on 20 October 2007, P14N-001 on 27 October 2007 to P14N-108 on 19 November 2007
MR07-06 Leg2:	P14N-109 on 23 November 2007 to P14N-185 on 12 December 2007 P14C-048 on 13 December 2007 to P14C-001 on 22 December 2007

(4) Data processing

(4.1) Sound velocity correction

The continuous bathymetry data are split into small areas around each CTD station. For each small area, the bathymetry data are corrected using a sound velocity profile calculated from the CTD data in the area. The equation of Mackenzie (1981) is used for calculating sound velocity. The data processing is carried out using “mbbath” command of MBsystem.

(4.2) Editing and Gridding

Gridding for the bathymetry data are carried out using the HIPS software version 5.4 (CARIS,

Canada). Firstly, the bathymetry data during a turn is basically removed before “base surface” is made. A spike noise of each swath data is also removed using “swath editor” and “subset editor”. Then the bathymetry data are gridded by “Interpolate” function of the software with following parameters.

BASE surface resolution : 50m x 50m

Interpolate matrix size: 5 x 5

Minimum number of neighbors for interpolate: 16

Finally, interpolated data is exported as ASCII data, and converted to 250m grid data using “xyz2grd” utility of GMT (Generic Mapping Tool) software

(5) Data Archive

Bathymetry data obtained during this cruise was submitted to the JAMSTEC Data Management Division, and archived there.

Reference

Mackenzie, K.V. (1981): Nine-term equation for the sound speed in the oceans, J. Acoust. Soc. Am., 70 (3), pp 807-812.

2.1.3 Sea surface gravity

(1) Personnel

Takeshi Matsumoto (University of the Ryukyus)

Principal Investigator / Not on-board:

Souichiro Sueyoshi (GODI)

Satoshi Okumura (GODI)

Shinya Okumura (GODI)

Kazuho Yoshida (GODI)

Harumi Ota (GODI)

Ryo Ohyama (GODI)

(2) Introduction

The difference of local gravity is an important parameter in geophysics. We collected gravity data at the sea surface during MR07-04 cruise from 23 Jul. 2007 to 2 Sep. 2007, MR07-06 Leg1 cruise from 7 Oct. 2007 to 19 Nov. 2007, Leg2 cruise from 23 Nov. 2007 to 23 Dec. 2007.

(3) Parameters

Relative Gravity [mGal]

(4) Data Acquisition

We have measured relative gravity using LaCoste and Romberg air-sea gravity system II (Micro-G LaCoste, Inc.) during this cruise. To convert the relative gravity to absolute one, we measured gravity, using portable gravity meter (Scintrex gravity meter CG-3M), at Sekinehama and Nakagusuku as reference points.

(5) Preliminary Results

Absolute gravity is shown in Table 2.2.3-1

Table 2.2.3-1 Absolute gravity table MR07-04 and MR07-06 cruise

No.	Date	UTC	Port	Absolute Gravity (mGal)	Sea Level (cm)	Draft (cm)	Gravity at Sensor ^{*1} (mGal)	L&R ^{*2} (mGal)
1	23/Jul/2007	06:16	Sekinehama	980371.94	261	615	980372.78	12642.60
2 ^{*3}	02/Oct/2007	07:03	Sekinehama	980371.94	215	603	980372.64	12642.29
3	07/Oct/2007	00:29	Sekinehama	980371.93	281	628	980372.84	12644.04
4 ^{*4}	25/Jan/2008	03:53	Nakagusuku	979114.70	285	628	979115.62	11386.68

*1: Gravity at Sensor= Absolute Gravity + Sea Level*0.3086/100 + (Draft-530)/100*0.0431

*2: LaCoste and Romberg air-sea gravity system II

*3: MR07-05 cruise

*4: MR07-07 Leg1 cruise

(6) Data Archive

Gravity data obtained during this cruise was submitted to the JAMSTEC Data Management Division, and archived there.

2.1.4 On-board geomagnetic measurement

(1) Personnel

Takeshi Matsumoto (University of the Ryukyus)

Principal Investigator / Not on-board:

Souichiro Sueyoshi (GODI)

Satoshi Okumura (GODI)

Shinya Okumura (GODI)

Kazuho Yoshida (GODI)

Harumi Ota (GODI)

Ryo Ohyama (GODI)

(2) Introduction

Measurements of magnetic force on the sea are required for the geophysical investigations of marine magnetic anomaly caused by magnetization in upper crustal structure. We measured geomagnetic field using a three-component magnetometer during MR07-04 cruise from 23 Jul. 2007 to 2 Sep. 2007, MR07-06 Leg1 cruise from 7 Oct. 2007 to 19 Nov. 2007, Leg2 cruise from 23 Nov. 2007 to 23 Dec. 2007.

(3) Method

A shipboard three-component magnetometer system (Tierra Tecnica SFG1214) is equipped on-board R/V Mirai. Three-axis flux-gate sensors with ring-cored coils are fixed on the fore mast. Outputs of the sensors are digitized by a 20-bit A/D converter (1 nT/LSB), and sampled at 8 times per second. Ship's heading, pitch and roll are measured utilizing a Fiber-Optic Gyro installed for Doppler radar system. Ship's position (GPS) and speed data are taken from Navigation data via LAN every second.

(4) Data Archive

Magnetic force data obtained during this cruise was submitted to the JAMSTEC Data Management Division, and archived there.

(5) Remarks

For calibration of the ship's magnetic effect, we made a "figure-eight" turn (a pair of clockwise and anti-clockwise rotation). This calibration was carried out as below.

MR07-04 cruise: 22 Aug 2007, 06:49 to 07:17 about at 46-59N, 152-31W

MR07-06 cruise: 03 Dec. 2007, 02:03 to 02:24 about at 00-03S, 179-20E

2.2 Surface Meteorological Observation

(1) Personnel

Kunio Yoneyama	(JAMSTEC)
Satoshi Okumura	(GODI)
Souichiro Sueyoshi	(GODI)
Shinya Okumura	(GODI)
Kazuho Yoshida	(GODI)
Ryo Ohyama	(GODI)
Harumi Ota	(GODI)

(2) Objective

As a basic dataset that describes weather conditions during the cruise, surface meteorological observation was continuously conducted.

(3) Methods

There are two different surface meteorological measurement systems on board the R/V MIRAI. One is the MIRAI surface meteorological observation system (SMET), and the other is the Shipboard Oceanographic and Atmospheric Radiation measurement system (SOAR).

Instruments of SMET are listed in Table 2.2.1. All SMET data were collected and processed by KOAC-7800 weather data processor made by Koshin Denki, Japan. Note that although SMET contains rain gauge, anemometer and radiometers in their system, we adopted those data from not SMET but SOAR due to the following reasons; 1) Since SMET rain gauge is located near the base of the mast, there is a possibility that its capture rate might be affected, 2) SOAR's anemometer has better starting threshold wind speed (1 m s^{-1}) comparing to SMET's anemometer (2 m s^{-1}), and 3) SMET's radiometers record data with 10 W/m^2 resolution, while SOAR takes high resolution data of 1 W/m^2 .

SOAR system was designed and constructed by the Brookhaven National Laboratory (BNL), USA, for an accurate measurement of solar radiation on the ship. Details of SOAR can be found at <http://www.gim.bnl.gov/soar/>. SOAR consists of 1) Portable Radiation Package (PRP) that measures short and long wave downwelling radiation, 2) Zeno meteorological system that measures pressure, air temperature, relative humidity, wind speed/direction, and rainfall, and 3) Scientific Computer System (SCS) developed by the National Oceanic and Atmospheric Administration (NOAA), USA, for data collection, management, real-time monitoring, and so on. Information on sensors used here is listed in Table 2.2.2.

Table 2.2.1. Instruments and locations of SMET.

Sensor	Parameter	Manufacturer / type	Location / height from sea level
Thermometer* ¹	air temperature relative humidity	Vaisala, Finland / HMP45A	compass deck* ² / 21 m
Thermometer	sea temperature	Sea-Bird Electronics, Inc./SBE3S* ³	4th deck / -5 m
Barometer	pressure	Setra Systems Inc., USA / 370	captain deck / 13 m

*1 Gill aspirated radiation shield 43408 made by R. M. Young, USA is attached.

*2 There are two thermometers at starboard and port sides.

*3 Sea surface temperature data were taken from EPCS surface water monitoring system.

Table 2.2.2. Instruments and locations of SOAR.

Sensor	Parameter	Manufacturer / type	Location / height from sea level
Anemometer	wind speed/direction	R. M. Young, USA / 05106	foremast / 25 m
Rain gauge	rainfall accumulation	R. M. Young, USA / 50202	foremast / 24 m
Radiometer	short wave radiation	Eppley, USA / PSP	foremast / 24 m
	long wave radiation	Eppley, USA / PIR	foremast / 24 m

(4) Data processing and data format

All raw data were recorded every 6 seconds. Datasets produced here are 1-minute mean values (time stamp at the end of the average). They are simple mean of 8 samples (10 samples minus maximum/minimum values) to exclude singular values. Linear interpolation onto missing values was applied only when their interval is less than 5 minutes.

Since the thermometers are equipped on both starboard/port sides on the deck, we used air temperature/relative humidity data taken at upwind side. Dew point temperature was produced from relative humidity and air temperature data.

No adjustment to sea level values is applied except pressure data.

Data are stored as ASCII format and contains following parameters. Time in UTC expressed as YYYYMMDDHHMM, time in Julian day (1.0000 = January 1, 0000Z), longitude (°E), latitude (°N), pressure (hPa), air temperature (°C), dew point temperature (°C), relative humidity (%), sea surface temperature (°C), zonal wind component (m/sec), meridional wind component (m/sec), precipitation (mm/hr), downwelling shortwave radiation (W/m²), and downwelling longwave radiation (W/m²).

Missing values are expressed as “9999”.

(5) Data Quality

To ensure the data quality, each sensor was calibrated as follows. Since there is a possibility for fine time resolution data sets to have some noises caused (generated) by turbulence, it is recommended to filter them out (ex. hourly mean) from this 1-minute mean data sets depending on the scientific purpose.

T/RH sensor:

Temperature and humidity probes were calibrated before/after the cruise by the manufacturer. Certificated accuracy of T/RH sensors are better than ± 0.2 °C and ± 2 %, respectively.

We also checked T/RH values using another calibrated portable T/RH sensor (Vaisala, HMP45A)

before and after the cruise. The results are,

Temperature (°C)

Mean difference between T (SMET) and T (portable) is

-0.23 ± 0.22 (°C) at port side, -0.06 ± 0.16 (°C) at starboard side.

Relative Humidity (%)

Mean difference between RH (SMET) and RH (portable) is

2.6 ± 1.3 (%) at port side, 1.7 ± 1.5 (%) at starboard side.

Sea surface temperature sensor:

Temperature sensor was calibrated before the cruise at the manufacturer. Certificated accuracy is better than 0.0002°C for MR07-04 cruise and 0.00003°C for MR07-06 cruise, respectively.

Pressure sensor:

Using calibrated portable barometer (Vaisala, Finland / PTB220, certificated accuracy is better than ± 0.1 hPa), pressure sensor was checked before/after the cruise. Mean difference of SMET pressure sensor and portable sensor is 0.04 ± 0.05 hPa.

Precipitation:

Before the cruise, we put water into the rain gauge to check their linearity between the indicated values and water amount input. Expected accuracy is better than ± 1 mm corresponding to the sensor’s specification. The results are as follows, and data were corrected using this relationship.

	MR07-04	MR07-06 Leg-1	Leg-2
minimum input water volume (cc)	0.0	0.0	0.0
minimum measured value (mm)	1.0	1.1	1.1
maximum input water volume (cc)	512.5	512.3	510.0
maximum measured value (mm)	51.8	51.9	51.9

Radiation sensors:

Short wave and long wave radiometers were calibrated by the manufacturer, Remote Measurement and Research Company, USA, prior to the cruise (April 2008).

(6) Data periods

MR07-04	0700 UTC, July 24, 2007 - 0000 UTC, September 2, 2007
MR07-06 Leg-1	2130 UTC, October 7, 2007 - 2110 UTC, November 20, 2007
MR07-06 Leg-2	0100 UTC, November 23, 2007 - 0130 UTC, December 23, 2007

(7) Point of contact

Kunio Yoneyama (yoneyamak@jamstec.go.jp)

IORGC / JAMSTEC, 2-15, Natsushima, Yokosuka 237-0061, Japan

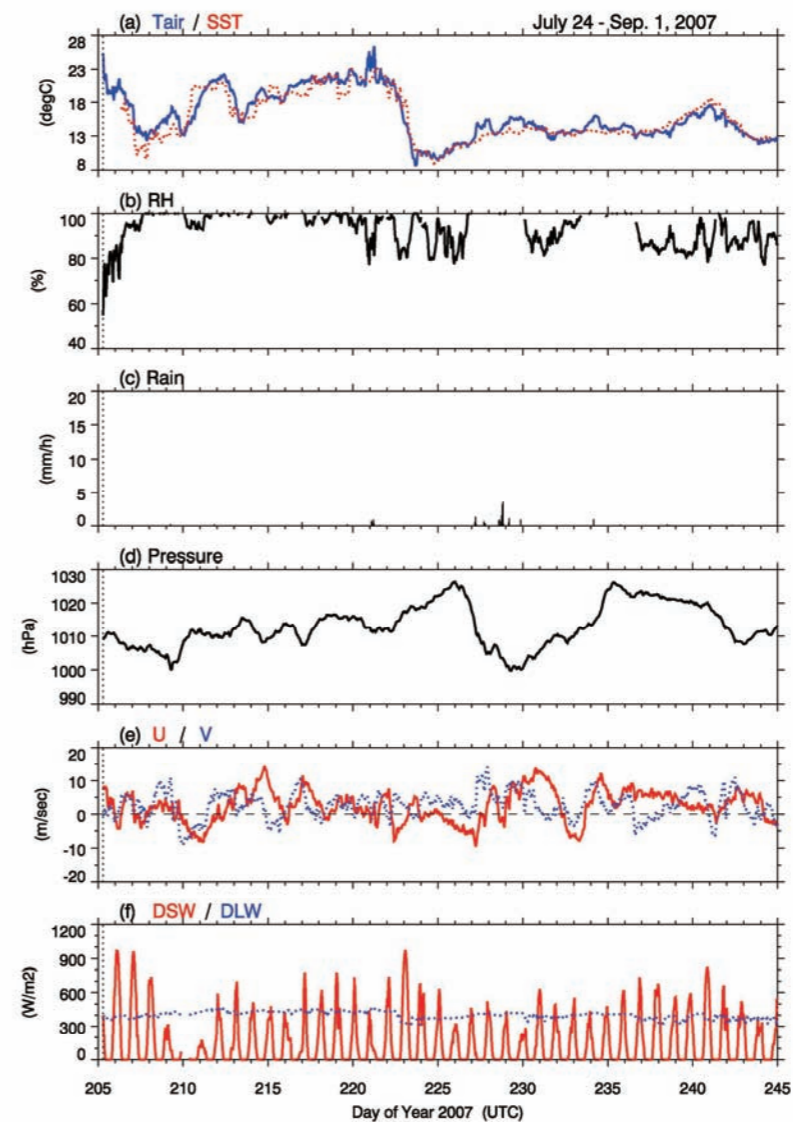

Figure 2.2.1. Time series of (a) air and sea surface temperature, (b) relative humidity, (c) precipitation, (d) pressure, (e) zonal and meridional wind components, and (e) short and long wave radiation for MR07-04 cruise data. Day 205 corresponds to July 24, 2007.

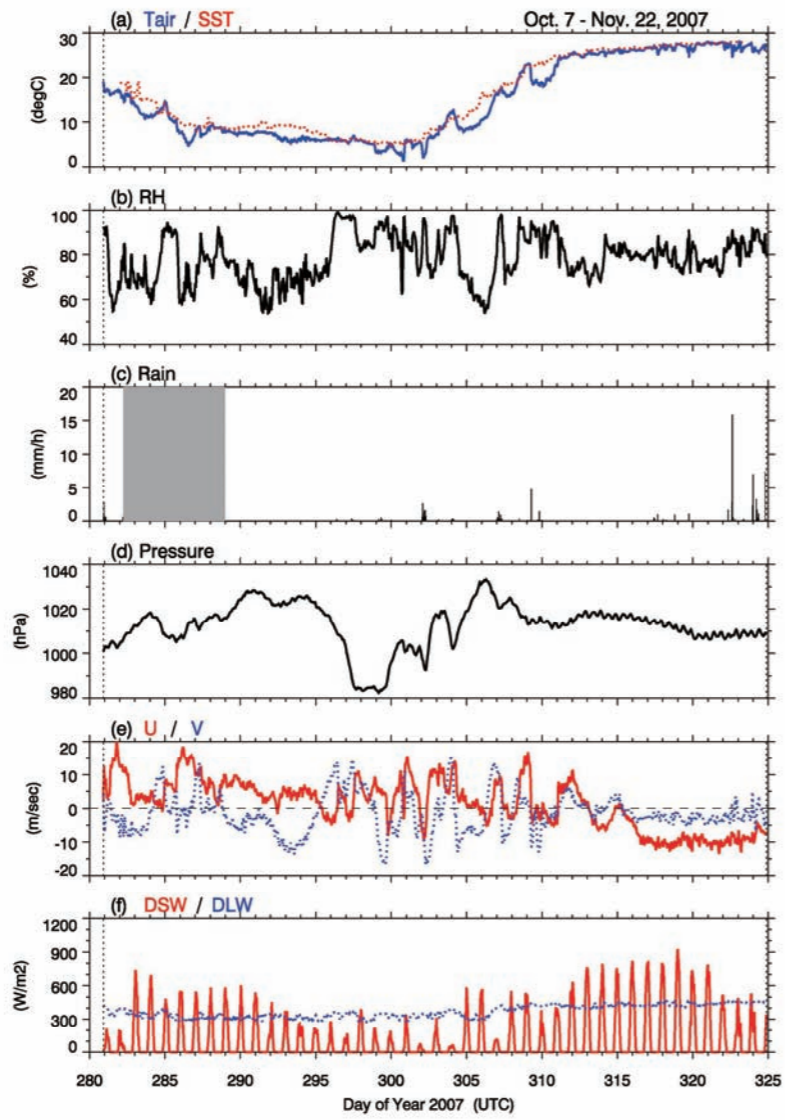

Figure 2.2.2. Same as Figure 2.2.1, but for MR07-06 leg 1 cruise. Day 280 corresponds to October 7, 2007. Shading in (c) indicates no data is available during this period.

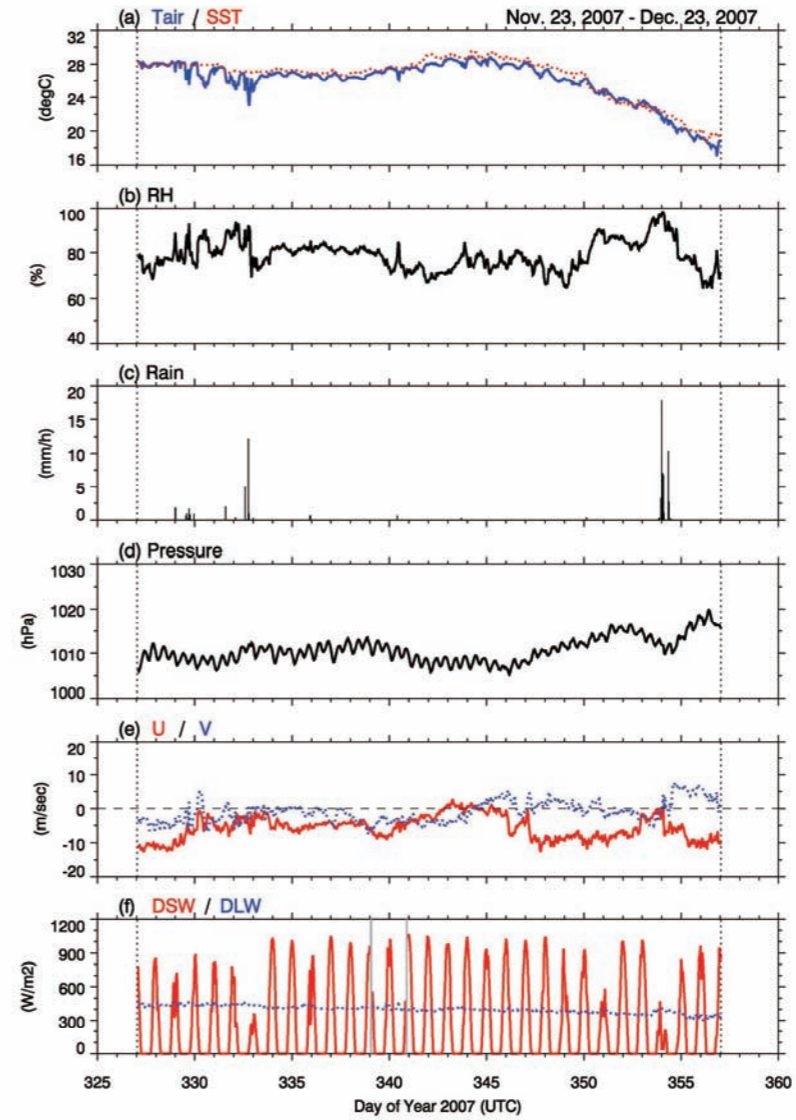

Figure 2.2.3. Same as Figure 2.2.1, but for MR07-06 leg 2 cruise. Day 325 corresponds to November 21, 2007.

2.3 Thermosalinograph and related measurements

9 September 2008

(1) Personnel

Yuichiro Kumamoto (JAMSTEC)

Kimiko Nishijima (MWJ)

Keisuke Wataki (MWJ)

Masanori Enoki (MWJ)

Miyo Ikeda (MWJ)

(2) Objective

Our purpose is to measure salinity, temperature, dissolved oxygen, and fluorescence in near-sea surface water during MR07-04 and MR07-06 cruises.

(3) Methods

The Continuous Sea Surface Water Monitoring System (Nippon Kaiyo Co. Ltd.), including the thermo-salinograph, has five sensors and automatically measures salinity, temperature, dissolved oxygen, and fluorescence in near-sea surface water every one minute. This system is located in the sea surface monitoring laboratory on R/V MIRAI and connected to shipboard LAN system. Measured data, time, and location of the ship were displayed on a monitor and then stored in a data management PC (IBM NetVista 6826-CBJ). The near-surface water was continuously pumped up to the laboratory from about 4 m water depth and flowed into the system through a vinyl-chloride pipe. The flow rate of the surface seawater was controlled by several valves and adjusted to be 12 L/min except for a fluorometer (about 0.5 L/min). The flow rate was measured by two flow meters. Specifications of the each sensor in this system are listed below.

a) Temperature and salinity sensors

SEACAT THERMOSALINOGRAPH

Model: SBE-21, SEA-BIRD ELECTRONICS, INC.
Serial number: MR07-04 [25 ~ 31 July]: 2641 (Cal. Date: 9 Feb. 2007)
MR07-04 [31 July ~ 1 Sep]: 3126 (Cal. Date: 1 Sep. 2006)
MR07-06: 2641 (Cal. Date: 9 Feb. 2007)
Measurement range: Temperature -5 to $+35^{\circ}\text{C}$, Salinity 0 to 6.5 S m^{-1}
Accuracy: Temperature 0.01°C 6month $^{-1}$, Salinity 0.001 S m^{-1} month $^{-1}$
Resolution: Temperatures 0.001°C , Salinity 0.0001 S m^{-1}

b) Bottom of ship thermometer

Model: SBE 3S, SEA-BIRD ELECTRONICS, INC.
Serial number: MR07-04: 2175 (Cal. Date: 15 Feb. 2007)
MR07-06: 2607 (Cal. Date: 10 Aug. 2007)
Measurement range: -5 to $+35^{\circ}\text{C}$
Resolution: $\pm 0.001^{\circ}\text{C}$
Stability: 0.002°C year $^{-1}$

c) Dissolved oxygen sensor

Model: 2127A, HACH ULTRA ANALYTICS JAPAN, INC.
Serial number: 47477
Measurement range: 0 to 14 ppm
Accuracy: $\pm 1\%$ at 5°C of correction range
Stability: 1% month $^{-1}$

d) Fluorometer

Model: 10-AU-005, TURNER DESIGNS
Serial number: 5562 FRXX
Detection limit: 5 ppt or less for chlorophyll-a
Stability: 0.5% month $^{-1}$ of full scale

e) Flow meter

Model: EMARG2W, Aichi Watch Electronics LTD.
Serial number: 8672

Measurement range: 0 to 30 l min⁻¹

Accuracy: ±1%

Stability: ±1% day⁻¹

(4) Measurements

Periods of measurement, maintenance, and problems during MR07-04 and MR07-06 are listed in Table 2.3.1. During MR07-04, SEB-21 was exchanged from S/N 2641 to S/N 3126 on July 31. During MR07-06, an antifoulant (antibiotic) device to prevent growth of aquatic organisms was detached from the SBE-21 sensors due to a problem on November 7. Due to this problem salinity data were lost between October 30 and November 7.

(5) Calibrations

(5.1) Comparison with bottle data

We collected the surface seawater samples for salinity sensor calibration (Table 2.3.2 and 2.3.3). The seawaters were collected approximately twice a day using a 250ml brown glass bottle. The samples were stored in the sea surface monitoring laboratory and then measured using the Guildline 8400B at the end of the legs after all the measurements of the hydrocast bottle samples (see section 3.2).

(5.2) Sensor calibrations

The sensors for temperature and salinity were calibrated before the cruise. After the cruise the sensors will be calibrated again in order to evaluate drifts of measurements during the cruise. The results of the calibrations are available via our web page, <http://www.jamstec.go.jp/cruisedata/mirai/e/index.html>.

(6) Data archive

Quality controlled data and meta-data are available via our web page, <http://www.jamstec.go.jp/cruisedata/mirai/e/index.html>.

Table 2.3.1 Events list of the thermo-salinograph during MR07-04 and MR07-06

Cruise	Date [UTC]	Time [UTC]	Event	Remarks
MR07-04	25-July-07	10:07	All the measurements started.	Departure Hachinohe
	31-July-07	20:49	All the measurements stopped. Checked SBE21(S/N2641)	
	31-July-07	22:19	All the measurements started. Exchanged SBE21(S/N2641 → S/N3126)	
	02-Aug.-07	23:15~23:16	Failure of data storage for location.	Unknown problem
	08-Aug.-07	01:01	All the measurements stopped.	Arrival Hachinohe
	10-Aug.-07	00:46	All the measurements started.	Departure Hachinohe
	01-Sep.-07	17:55	All the measurements stopped.	Arrival Dutch Harbor
MR07-06	9-Oct.-07	02:17	All the measurements started.	Departure Hachinohe (Leg-1 start)
	05-Nov.-07	14:31~14:35	Lost of all the data.	Due to a tripping of a circuit breaker
	30-Oct.-07	03:36	Lost of salinity data.	Due to a problem of the antibiotic device
	07-Nov.-07	04:08		
	07-Nov.-07	04:09~05:04	Lost of all the data.	Reboot of the data management PC
	18-Nov.-07	04:35	Failure of RMT temperature data archive.	Due to a noise in the data
	19-Nov.-07	07:36	All the measurements stopped.	Arrival Majuro (Leg-1 end)
	23-Nov.-07	02:00	All the measurements started.	Departure Majuro (Leg-2 start)
23-Dec.-07	01:28	All the measurements stopped.	Arrival Auckland (Leg-2 end)	

Table 2.3.2 Comparison of the sensor salinity with the bottle salinity during MR07-04.

Date [UTC]	Time [UTC]	Latitude	Longitude	Sensor salinity [PSS-78]	Bottle salinity [PSS-78]	Difference [Sen. - Bot.]
2007/7/25	11:45	40-59.56800N	143-01.10930E	33.5532	33.5435	0.0097
2007/7/25	22:50	41-25.73860N	145-33.00760E	33.1134	33.1092	0.0042
2007/7/26	7:50	42-48.17710N	145-27.19090E	33.0332	32.9148	0.1184
2007/7/26	18:35	42-39.75580N	145-41.41540E	32.8070	32.7676	0.0394
2007/7/27	6:57	42-10.79830N	146-05.03190E	32.7934	32.7528	0.0406
2007/7/27	18:26	41-52.48810N	146-18.41610E	32.6836	32.6956	-0.0120
2007/7/28	6:25	41-42.78640N	146-26.08430E	32.7105	32.7144	-0.0039
2007/7/28	17:42	41-21.42700N	146-41.11320E	32.7118	32.7226	-0.0108
2007/7/29	6:17	40-50.82040N	147-04.04230E	32.7539	32.8174	-0.0635
2007/7/29	18:17	40-07.44810N	147-33.93700E	34.3895	34.3785	0.0110
2007/7/30	6:15	39-41.50140N	147-55.39620E	34.3704	34.3733	-0.0029
2007/7/30	18:49	40-19.26800N	148-52.31960E	34.4994	34.4946	0.0048
2007/7/31	6:58	40-55.49780N	149-51.04410E	34.4920	34.4889	0.0031
2007/7/31	19:15	41-33.67610N	150-52.33380E	33.0052	32.9972	0.0080
2007/8/1	7:01	42-20.17860N	152-05.04200E	33.2326	33.2204	0.0122
2007/8/1	17:05	42-40.53890N	152-42.26540E	33.0865	33.0802	0.0063
2007/8/2	3:43	42-46.24720N	152-52.61200E	33.0909	33.086	0.0049
2007/8/2	14:40	42-16.33730N	153-02.98470E	33.7921	33.7798	0.0123
2007/8/3	11:06	41-09.40780N	153-00.48910E	34.5137	34.5066	0.0071
2007/8/3	21:09	40-32.21620N	153-00.60930E	33.7968	33.8032	-0.0064
2007/8/4	8:43	40-00.34550N	153-01.61040E	34.1606	34.1553	0.0053
2007/8/4	23:16	40-11.85680N	153-09.64890E	33.8481	33.844	0.0041
2007/8/5	7:25	40-12.99160N	152-33.21310E	33.9156	33.9139	0.0017
2007/8/5	22:56	40-18.83730N	150-22.60930E	33.5227	33.5537	-0.0310
2007/8/6	8:29	40-21.15240N	148-57.04860E	33.7495	33.712	0.0375
2007/8/6	22:49	40-24.15980N	147-13.70230E	34.4521	34.4463	0.0058
2007/8/7	8:34	40-26.14660N	146-01.54310E	33.6041	33.5854	0.0187

2007/8/10	3:29	40-30.47580N	148-30.41270E	32.6756	32.6924	-0.0168
2007/8/10	15:38	41-45.96810N	152-21.06700E	33.0687	33.0622	0.0065
2007/8/11	2:43	43-18.92240N	155-37.71560E	33.9769	33.9437	0.0332
2007/8/11	7:34	44-05.47490N	156-59.82140E	32.8430	32.8564	-0.0134
2007/8/11	21:08	46-15.85980N	160-54.30660E	32.9301	32.9136	0.0165
2007/8/12	10:23	47-00.16990N	163-58.87420E	32.7841	32.8029	-0.0188
2007/8/12	20:49	46-59.16850N	166-44.32290E	32.8503	32.8436	0.0067
2007/8/13	10:17	47-00.34900N	171-07.85130E	32.7411	32.7608	-0.0197
2007/8/13	22:10	47-00.12300N	175-35.01600E	32.8015	32.8139	-0.0124
2007/8/14	12:08	46-59.93210N	178-18.23620E	32.7989	32.7947	0.0042
2007/8/14	21:53	47-00.83360N	179-26.98080E	32.7283	32.7244	0.0039
2007/8/15	9:26	46-59.51960N	178-18.91400W	32.6862	32.6819	0.0043
2007/8/15	21:48	47-00.07570N	176-37.54620W	32.5401	32.5288	0.0113
2007/8/16	9:45	47-00.04090N	174-56.44210W	32.6165	32.6103	0.0062
2007/8/16	21:05	46-59.78510N	172-42.64610W	32.7305	32.7317	-0.0012
2007/8/17	8:58	47-00.42840N	171-15.40150W	32.6261	32.6201	0.0060
2007/8/17	20:13	46-59.66060N	169-20.49430W	32.5481	32.5443	0.0038
2007/8/18	8:55	47-00.45780N	167-05.29050W	32.6200	32.6132	0.0068
2007/8/18	21:57	47-01.17270N	164-59.92870W	32.7182	32.7068	0.0114
2007/8/19	7:47	47-00.44260N	163-43.31850W	32.6417	32.6403	0.0014
2007/8/19	20:06	47-00.56460N	161-29.41830W	32.6488	32.6454	0.0034
2007/8/20	8:42	46-59.45290N	159-40.89610W	32.8259	32.7851	0.0408
2007/8/20	19:06	47-00.21960N	158-08.58960W	32.6516	32.6507	0.0009
2007/8/21	8:05	46-59.50660N	155-51.80530W	32.6803	32.6594	0.0209
2007/8/21	20:49	47-00.05950N	153-38.13320W	32.6733	32.6492	0.0241
2007/8/22	8:51	46-57.98700N	152-03.39390W	32.5771	32.5925	-0.0154
2007/8/22	21:01	46-59.89670N	151-37.39790W	32.5729	32.5669	0.0060
2007/8/23	7:05	46-59.11440N	150-17.59340W	32.5377	32.5289	0.0088
2007/8/23	19:37	47-00.48950N	148-02.17190W	32.4434	32.4448	-0.0014
2007/8/24	7:13	46-59.97990N	145-48.73560W	32.4713	32.3907	0.0806
2007/8/24	19:29	46-59.56400N	143-40.41810W	32.3720	32.3577	0.0143
2007/8/25	6:47	46-59.96520N	141-54.50520W	32.3190	32.3614	-0.0424

2007/8/25	21:10	47-00.04030N	139-04.06470W	32.4736	32.4163	0.0573
2007/8/26	7:39	46-59.23350N	137-29.04750W	32.4100	32.4496	-0.0396
2007/8/26	17:20	46-59.98240N	135-43.90950W	32.4774	32.4267	0.0507
2007/8/27	5:59	46-59.30070N	133-27.95720W	32.4447	32.4419	0.0028
2007/8/27	17:02	47-00.38230N	131-13.71710W	32.3672	32.3549	0.0123
2007/8/28	6:43	47-00.11040N	128-38.31500W	32.3364	32.2963	0.0401
2007/8/28	18:37	47-00.30230N	126-28.19600W	32.0321	32.1002	-0.0681*
2007/8/29	6:10	46-55.65720N	124-58.92520W	31.8860	31.581	0.3050*
2007/8/29	16:56	48-01.70010N	127-57.81150W	31.8923	32.3276	-0.4353*
2007/8/30	7:34	49-37.43780N	132-44.53330W	32.2969	32.0908	0.2061*

* Difference between the sensor and the bottle salinity is large.

Table 2.3.3 Comparison of the sensor salinity with the bottle salinity during MR07-06

Date [UTC]	Time [UTC]	Latitude	Longitude	Sensor salinity [PSS-78]	Bottle salinity [PSS-78]	Difference [Sen. - Bot.]
2007/10/9	5:25	40-32.06180N	144-33.13440E	33.8540	33.8458	0.0082
2007/10/9	14:12	40-22.40990N	146-42.40840E	33.6539	33.7204	-0.0665*
2007/10/10	2:55	41-05.85970N	150-18.13910E	33.0454	33.0327	0.0127
2007/10/10	17:23	42-20.76330N	152-09.03380E	33.0246	33.0196	0.0050
2007/10/11	6:36	43-04.88550N	153-19.58350E	32.8880	32.8815	0.0065
2007/10/11	18:27	44-04.74300N	154-59.84680E	32.6292	32.6202	0.0090
2007/10/12	6:42	44-20.23280N	155-24.25840E	32.6718	32.6882	-0.0164
2007/10/12	18:48	45-04.93350N	156-38.62630E	32.6208	32.6191	0.0017
2007/10/13	6:20	46-05.23470N	158-20.15860E	32.6245	32.6095	0.0150
2007/10/13	17:47	46-30.35720N	159-06.53620E	32.6256	32.6067	0.0189
2007/10/14	6:03	47-01.02970N	160-08.89530E	32.6805	32.6503	0.0302
2007/10/14	17:40	46-59.52310N	162-15.61480E	32.6576	32.6517	0.0059
2007/10/15	5:48	47-00.14140N	164-21.29860E	32.7218	32.7181	0.0037
2007/10/15	18:09	46-59.07380N	165-37.89780E	32.7204	32.7177	0.0027
2007/10/16	5:45	46-57.67950N	166-43.18590E	32.7198	32.7006	0.0192
2007/10/16	17:21	46-59.41470N	168-22.56610E	32.6269	32.6230	0.0039
2007/10/17	4:43	47-00.57730N	169-05.85870E	32.6415	32.6348	0.0067
2007/10/17	16:50	46-58.65870N	169-48.59680E	32.6433	32.6435	-0.0002
2007/10/18	4:37	46-59.83390N	170-28.31700E	32.6664	32.6637	0.0027
2007/10/18	17:37	47-00.36100N	172-11.21260E	32.6925	32.6908	0.0017
2007/10/19	4:00	47-00.24210N	173-49.77000E	32.6660	32.6612	0.0048
2007/10/19	17:22	46-59.80860N	176-05.82360E	32.6682	32.6711	-0.0029
2007/10/20	4:52	46-59.40840N	177-23.84440E	32.7044	32.6961	0.0083
2007/10/20	17:22	47-00.00850N	179-26.22310E	32.7052	32.6981	0.0071
2007/10/21	4:47	47-59.94950N	178-58.96240E	32.7126	32.7113	0.0013
2007/10/21	16:29	48-59.35410N	178-58.98940E	32.7462	32.7458	0.0004
2007/10/22	5:27	50-00.83360N	178-58.88290E	32.7591	32.7558	0.0033

2007/10/22	16:31	50-28.96300N	179-17.18900E	32.7410	32.7375	0.0035
2007/10/23	4:21	50-56.90210N	179-34.72020E	32.7865	32.7856	0.0009
2007/10/23	17:34	51-49.39240N	179-48.31570W	33.1172	33.0838	0.0334
2007/10/24	4:31	52-16.13690N	178-58.41500W	33.0384	33.0340	0.0044
2007/10/24	16:44	53-29.70310N	178-14.46000W	33.0212	32.9384	0.0828*
2007/10/25	4:14	54-29.63280N	177-33.24850W	32.9897	33.0030	-0.0133
2007/10/25	16:43	55-46.93320N	176-39.18100W	32.9090	32.8842	0.0248
2007/10/26	5:22	56-58.85310N	175-40.15170W	32.6355	32.6284	0.0071
2007/10/26	18:01	57-59.76550N	174-49.90480W	32.5895	32.5258	0.0637*
2007/10/27	4:57	58-08.08730N	174-44.48860W	32.5030	32.3429	0.1601*
2007/10/27	17:19	56-30.05810N	176-03.67350W	32.5951	32.7054	-0.1103*
2007/10/28	4:39	54-08.81850N	177-54.30220W	32.9045	32.9649	-0.0604*
2007/10/28	13:05	52-32.19380N	179-08.82310W	33.0417	33.0057	0.0360
2007/10/29	4:01	50-14.37020N	179-37.14930E	32.7248	32.7183	0.0065
2007/10/29	14:42	47-41.52110N	179-02.67540E	32.7274	32.6862	0.0412
2007/10/30	3:41	46-53.64970N	179-22.82010E	-	32.6969	-
2007/10/30	15:14	45-59.16150N	179-01.56400E	-	32.6628	-
2007/10/31	3:35	45-00.74700N	178-57.16110E	-	32.8870	-
2007/10/31	15:15	44-25.17970N	178-59.33940E	-	32.9982	-
2007/11/1	3:39	43-25.96290N	179-02.30580E	-	33.0939	-
2007/11/1	15:26	42-28.59190N	178-59.11440E	-	33.4875	-
2007/11/2	3:12	41-23.64650N	179-01.51310E	-	33.8685	-
2007/11/2	15:27	40-20.81390N	178-59.78120E	-	33.9810	-
2007/11/3	3:24	39-26.10410N	179-02.86940E	-	33.9847	-
2007/11/3	15:45	38-23.33390N	178-58.98450E	-	34.2733	-
2007/11/4	3:31	37-18.29470N	179-01.24320E	-	34.1793	-
2007/11/4	16:00	35-59.85240N	179-00.06330E	-	34.3576	-
2007/11/5	3:58	35-00.12920N	179-00.07790E	-	34.3425	-
2007/11/5	15:55	33-44.35400N	178-59.55440E	-	34.3342	-
2007/11/6	3:11	32-29.25280N	178-59.81090E	-	34.4613	-
2007/11/6	15:20	31-30.00990N	179-01.02830E	-	34.9858	-
2007/11/7	3:58	30-29.46880N	178-58.82510E	-	34.8471	-

2007/11/7	15:23	29-29.82960N	178-59.54800E	35.0656	35.0616	0.0040
2007/11/8	3:31	28-29.09130N	178-59.81260E	35.1072	35.1020	0.0052
2007/11/8	15:09	27-29.82050N	179-00.43770E	35.1408	35.1350	0.0058
2007/11/9	3:38	26-29.73090N	179-00.05290E	35.1328	35.1256	0.0072
2007/11/9	15:02	26-01.48300N	179-09.89370E	35.2352	35.2285	0.0067
2007/11/10	3:35	25-55.53690N	179-35.36160E	35.1871	35.1823	0.0048
2007/11/10	14:53	25-37.38100N	179-08.77730E	35.1945	35.1835	0.0110
2007/11/11	3:32	25-00.00200N	179-00.87020E	35.1259	35.1160	0.0099
2007/11/11	15:07	24-00.25110N	178-59.54920E	35.1751	35.1667	0.0084
2007/11/12	3:25	23-00.17370N	178-59.73550E	35.1788	35.1675	0.0113
2007/11/12	15:29	22-00.68720N	178-59.79810E	35.2859	35.2776	0.0083
2007/11/13	3:54	20-40.66570N	178-59.76420E	35.2590	35.2487	0.0103
2007/11/13	15:15	19-30.66360N	179-00.02710E	34.9384	34.9276	0.0108
2007/11/14	3:29	18-30.92670N	179-00.39380E	34.9828	34.9705	0.0123
2007/11/14	15:43	17-31.50610N	178-59.80200E	34.7915	34.7802	0.0113
2007/11/15	4:07	16-24.89740N	178-59.54480E	34.6641	34.6546	0.0095
2007/11/15	15:30	15-30.91970N	178-59.09970E	34.7727	34.7595	0.0132
2007/11/16	3:36	14-30.31750N	178-58.52030E	34.7215	34.7105	0.0110
2007/11/16	15:14	13-30.46350N	178-59.04190E	34.6934	34.6809	0.0125
2007/11/17	3:25	12-31.37000N	178-59.21560E	34.5697	34.5586	0.0111
2007/11/17	15:21	11-31.21370N	178-59.68420E	34.3699	34.3584	0.0115
2007/11/18	4:03	10-30.99360N	178-59.81610E	34.3508	34.3394	0.0114
2007/11/18	15:29	09-29.79300N	178-49.30000E	34.2541	34.2427	0.0114
2007/11/19	4:12	08-45.75560N	178-59.25940E	34.0907	34.0779	0.0128
2007/11/19	7:34	08-30.49010N	178-59.17670E	34.0624	34.0496	0.0128
2007/11/23	6:21	08-28.64970N	177-35.78940E	34.3121	34.2969	0.0152
2007/11/23	20:57	08-30.58210N	178-59.31190E	34.2402	34.2239	0.0163
2007/11/24	4:35	08-15.65310N	178-59.95810E	34.2931	34.2779	0.0152
2007/11/24	15:11	07-44.86660N	179-00.67490E	34.3735	34.3571	0.0164
2007/11/25	5:25	06-59.91330N	179-00.06250E	34.9224	34.9055	0.0169
2007/11/25	15:03	06-43.39460N	179-01.10810E	34.9023	34.8856	0.0167
2007/11/26	9:02	05-48.04660N	179-00.02110E	34.6940	34.6773	0.0167

2007/11/26	19:05	05-26.90940N	178-59.91100E	34.8380	34.8221	0.0159
2007/11/27	3:34	04-59.55490N	178-59.60990E	34.9097	34.8895	0.0202
2007/11/27	15:19	04-28.97130N	179-00.63150E	35.1440	35.1281	0.0159
2007/11/28	3:45	03-59.53280N	179-00.29860E	35.1021	35.0869	0.0152
2007/11/28	15:44	03-30.23710N	179-00.16020E	35.1012	35.0856	0.0156
2007/11/29	3:36	03-00.21240N	179-00.13510E	35.1367	35.1212	0.0155
2007/11/29	16:01	02-18.22210N	179-00.16430E	35.1347	35.1212	0.0135
2007/11/30	3:55	01-46.88070N	178-59.98650E	35.1377	35.1235	0.0142
2007/11/30	15:31	01-15.66770N	179-00.43110E	35.1435	35.1276	0.0159
2007/12/1	3:46	00-44.30730N	178-59.59540E	35.1914	35.1760	0.0154
2007/12/1	15:37	00-14.79480N	178-59.80660E	35.2090	35.1943	0.0147
2007/12/2	4:15	00-14.67970S	178-59.64810E	35.2218	35.2073	0.0145
2007/12/2	12:41	00-10.57770S	179-06.94120E	35.2325	35.2174	0.0151
2007/12/3	4:52	00-12.28510S	179-04.73820E	35.2249	35.2099	0.0150
2007/12/3	14:57	00-44.44420S	179-00.38430E	35.2623	35.2469	0.0154
2007/12/4	3:20	01-14.79930S	178-59.80360E	35.3369	35.3212	0.0157
2007/12/4	15:34	01-44.20500S	178-59.90450E	35.4360	35.4201	0.0159
2007/12/5	3:22	02-17.59460S	178-59.93920E	35.6036	35.5869	0.0167
2007/12/5	15:24	02-53.72300S	178-59.76740E	35.6056	35.5887	0.0169
2007/12/6	3:06	03-27.43530S	179-00.16390E	35.7017	35.6843	0.0174
2007/12/6	15:36	04-00.42580S	179-00.22410E	35.6937	35.6779	0.0158
2007/12/7	3:32	04-30.49320S	179-00.53770E	35.7250	35.7082	0.0168
2007/12/7	15:32	04-59.93530S	179-00.01310E	35.5754	35.5597	0.0157
2007/12/8	3:45	06-00.49190S	179-00.46560E	35.3242	35.3077	0.0165
2007/12/8	14:36	06-53.23310S	178-59.79630E	34.9645	34.9512	0.0133
2007/12/9	4:03	08-00.07870S	178-59.79360E	34.9440	34.9289	0.0151
2007/12/9	15:36	09-00.39210S	178-59.93910E	34.8335	34.8182	0.0153
2007/12/10	3:40	10-00.45970S	178-59.86400E	34.9014	34.8881	0.0133
2007/12/10	15:18	11-13.93150S	178-59.74590E	34.7253	34.7089	0.0164
2007/12/11	3:33	12-30.37470S	178-59.91460E	34.6997	34.7019	-0.0022
2007/12/11	15:51	13-46.37280S	179-00.26670E	34.7411	34.7252	0.0159
2007/12/12	4:00	15-22.73890S	178-59.73240E	34.5721	34.5526	0.0195

2007/12/12	15:19	16-12.74140S	177-54.43780E	34.4854	34.4725	0.0129
2007/12/13	4:35	18-00.97310S	176-45.86950E	34.5336	34.5170	0.0166
2007/12/13	14:24	18-50.60070S	177-46.34680E	34.6658	34.6499	0.0159
2007/12/14	3:17	18-55.97910S	177-42.97910E	34.6754	34.6600	0.0154
2007/12/14	15:33	19-28.61270S	177-27.00180E	34.6839	34.6687	0.0152
2007/12/15	3:23	20-07.58350S	177-31.91270E	34.8697	34.8541	0.0156
2007/12/15	14:34	20-49.63040S	177-33.64870E	34.7734	34.7594	0.0140
2007/12/16	3:13	21-27.06220S	177-28.28690E	34.7654	34.7500	0.0154
2007/12/16	14:27	22-35.48470S	177-15.81440E	35.1803	35.1668	0.0135
2007/12/17	3:34	23-28.79280S	177-06.59720E	35.2719	35.2571	0.0148
2007/12/17	15:22	24-33.84780S	176-55.51780E	35.3974	35.3832	0.0142
2007/12/18	3:14	25-40.20740S	176-44.22250E	35.3818	35.3685	0.0133
2007/12/18	15:32	26-32.00690S	176-35.73230E	35.5411	35.5272	0.0139
2007/12/19	3:17	27-42.58850S	176-23.83980E	35.3077	35.2935	0.0142
2007/12/19	14:58	28-42.40730S	176-13.37440E	35.4757	35.4621	0.0136
2007/12/20	3:33	29-47.61200S	175-58.31910E	35.5968	35.5770	0.0198
2007/12/20	15:37	30-52.84490S	175-51.55180E	35.6651	35.6505	0.0146
2007/12/21	3:21	31-44.20450S	175-43.19030E	35.6629	35.6484	0.0145
2007/12/21	15:40	32-49.34980S	175-32.03160E	35.7132	35.6991	0.0141
2007/12/22	3:07	33-42.10310S	175-23.62260E	35.6878	35.6729	0.0149
2007/12/22	15:06	35-01.27420S	175-09.08010E	35.7422	35.7286	0.0136
2007/12/23	1:20	35-33.05740S	175-08.87520E	35.6953	35.6812	0.0141

* Difference between the sensor and the bottle salinity is large.

2.4 Underway pCO₂

9 November 2008

(1) Personnel

Akihiko Murata (IORGC, JAMSTEC)

Yoshiko Ishikawa (MWJ)

Yasuhiro Aarii (MWJ)

Mikio Kitada (MWJ)

(2) Objectives

Concentrations of CO₂ in the atmosphere are now increasing at a rate of 1.5 ppmv y⁻¹ due to human activities such as burning of fossil fuels, deforestation, cement production, etc. It is an urgent task to estimate as accurately as possible the absorption capacity of the ocean against the increased atmospheric CO₂, and to clarify the mechanism of the CO₂ absorption, because the magnitude of the predicted global warming depends on the levels of CO₂ in the atmosphere, and because the ocean currently absorbs 1/3 of the 6 Gt of carbon emitted into the atmosphere each year by human activities.

In the P1 and P14 revisit cruises, we were aimed at quantifying how much anthropogenic CO₂ is absorbed in the surface ocean in the Pacific. For the purpose, we measured pCO₂ (partial pressures of CO₂) in the atmosphere and in the surface seawater.

(3) Apparatus and shipboard measurement

Continuous underway measurements of atmospheric and surface seawater pCO₂ were made with the CO₂ measuring system (Nippon ANS, Ltd) installed in the R/V *Mirai* of JAMSTEC. The system comprises of a non-dispersive infrared gas analyzer (NDIR; BINOS[®] model 4.1, Fisher-Rosemount), an air-circulation module and a showerhead-type equilibrator. To measure concentrations (mole fraction) of CO₂ in dry air (xCO_{2a}), air sampled from the bow of the ship (approx. 30 m above the sea level) was

introduced into the NDIR through a dehydrating route with an electric dehumidifier (kept at ~-2 °C), a Perma Pure dryer (GL Sciences Inc.), and a chemical desiccant (Mg(ClO₄)₂). The flow rate of the air was 500 ml min⁻¹. To measure surface seawater concentrations of CO₂ in dry air (xCO_{2s}), the air equilibrated with seawater within the equilibrator was introduced into the NDIR through the same flow route as the dehydrated air used in measuring xCO_{2a}. The flow rate of the equilibrated air was 600 – 800 ml min⁻¹. The seawater was taken by a pump from the intake placed at the approx. 4.5 m below the sea surface. The flow rate of seawater in the equilibrator was 500 – 800 ml min⁻¹.

The CO₂ measuring system was set to repeat the measurement cycle such as 4 kinds of CO₂ standard gases (Table 2.4.1), xCO_{2a} (twice), xCO_{2s} (7 times). This measuring system was run automatically throughout the cruise by a PC control.

(4) Quality control

Concentrations of CO₂ of the standard gases are listed in Table 2.4.1, which were calibrated by the JAMSTEC primary standard gases. The CO₂ concentrations of the primary standard gases were calibrated by C.D. Keeling of the Scripps Institution of Oceanography, La Jolla, CA, USA.

Since differences of concentrations of the standard gases between before and after the cruise were allowable (< 0.1 ppmv), the averaged concentrations (Table 2.4.1) were adopted for the subsequent calculations.

In actual shipboard observations, the signals of NDIR usually reveal a trend. The trends were adjusted linearly using the signals of the standard gases analyzed before and after the sample measurements.

Effects of water temperature increased between the inlet of surface seawater and the equilibrator on xCO_{2s} were adjusted based on Gordon and Jones (1973), although the temperature increases were slight, being ~ 0.3 °C.

We checked values of xCO_{2a} and xCO_{2s} by examining signals of the NDIR on recorder charts, and by plotting the xCO_{2a} and xCO_{2s} as a function of sequential day, longitude, sea surface temperature and

sea surface salinity.

Reference

Gordon, L. I. and L. B. Jones (1973) The effect of temperature on carbon dioxide partial pressure in seawater. Mar. Chem., 1, 317-322.

Table 2.4.1. Concentrations of CO₂ standard gases used in (a) P1 and (b) P14 revisit cruises

(a)

Cylinder no.	Concentrations (ppmv)
CQB09356	289.77
CQB15439	349.02
CQB15432	394.23
CQB09375	439.75

(b)

Cylinder no.	Concentrations (ppmv)
CQB06555	270.02
CQB19242	330.40
CQB15437	369.28
CQB09327	419.68

2.5 Acoustic Doppler Current Profiler

5 November 2008

(1) Personnel

Shinya Kouketsu (JAMSTEC)

Hiroshi Uchida (JAMSTEC)

Satoshi Okumura (GODI)

Shinya Okumura (GODI)

Ryo Oyama (GODI)

Kazuho Yoshida (GODI)

(2) Instruments and method

The instrument used was an RDI 76.8 kHz unit, hull-mounted on the centerline and approximately 23 m aft of the bow at the water line. The firmware version was 5.59 and the data acquisition software was the RDI VMDAS Version. 1.4. The Operation was made from the first CTD station to the last CTD station in each leg. It was continued to the Auckland port in the third leg. The instrument was used in the water-tracking mode during the most of operations, recording each ping raw data in 8 m x 100 bins from about 23 m to 735 m in deep. Typical sampling interval was 3.5 seconds. Bottom track mode was added in the easternmost shallow water region. GPS gave the navigation data. Two kinds of compass data were recorded. One was the ship's gyrocompass which is connected the ADCP system directory, were stored with the ADCP data. Current field based on the gyrocompass was used to check the operation and the performance on board. Another compass used was the Inertial Navigation Unit (INU), DRU-H, Honeywell Inc. Its accuracy is 1.0 mile (about 0.056 degree) and had already set on zero bias before the beginning of the cruise. The INU compass data were stored independently, and were combined with the ADCP data after the cruise.

(3) Performance of the ADCP data

The performance of the ADCP instrument was almost good: on streaming, profiles usually reached to about 600 m. Profiles were rather bad on CTD station. The profiles were sometimes obtained from 200 m to 500 m. In these cases the ADCP signal was weak typically at about 350 m in deep. It is probably due to the babbles from the bow-thruster. Echo intensities for each legs changed due to environment of sea (Fig. 2.5.1), although the intensities were not different by each beams. During MR07-04 in which we observed in the subarctic region, enough echo intensities for good observation (over 60 counts) were obtained up to bin number of 50.

(4) Data processing

We processed ADCP data as described below. ADCP-coordinate velocities were converted to the earth-coordinate velocities using the ship heading from the INU. The earth-coordinate currents were obtained by subtracting ship velocities from the earth-coordinate velocities. Corrections of the misalignment and scale factors were made using the bottom track data for each legs. The misalignment angle calculated was 0.5, 1, and 1 degree and the scale factor was 0.975 for MR07-04, MR07-06 leg1 and MR07-06 leg2, respectively.

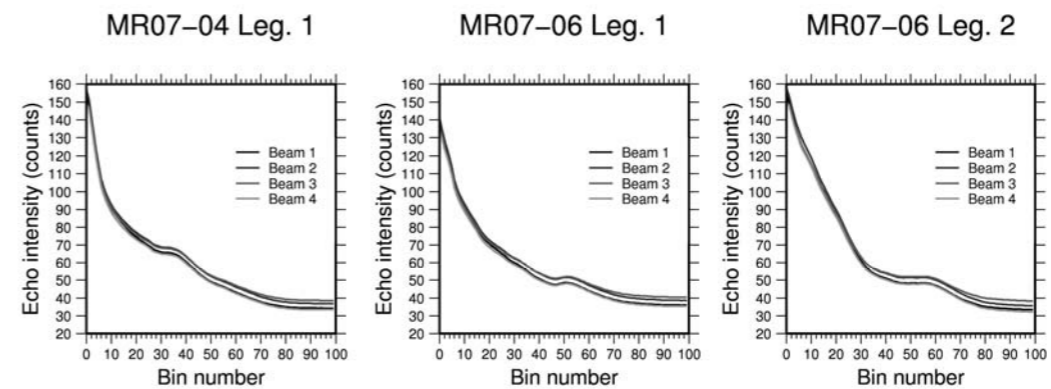

Fig. 2.5.1. Cruise-averaged echo intensities for each beams by bins.

2.6 XCTD

4 November 2008

(1) Personnel

Hiroshi Uchida (JAMSTEC)

Satoshi Okumura (GODI)

Shinya Okumura (GODI)

Ryo Ohyama (GODI)

(2) Objectives

Expendable Conductivity, Temperature and Depth profiler (XCTD) measurements were carried out to obtain upper ocean temperature and salinity data at CTD stations skipped over in the cruise MR07-04.

(3) Instrument and Method

The XCTD used was XCTD-1 (Tsurumi-Seiki Co., Ltd., Yokohama, Kanagawa, Japan) with a MK-100 deck unit (Tsurumi-Seiki Co., Ltd.). Ship's speed was slowed down to 12 knot during the XCTD measurement. In the cruise MR07-04, 17 XCTD-1 probes were deployed by using 8-loading automatic launcher (Tsurumi-Seiki Co., Ltd.), except for stations P01_42, 51, 53, 54, 55, 56, and 57 at which the XCTD probes were deployed by using hand launcher from the stern of the upper deck due to communication error.

(4) Data Processing and Quality Control

The XCTD data were processed and quality controlled based on a method by Uchida and Imawaki (2008) with slight modification. The followings are the data processing sequence used in the reduction of the XCTD data.

1. Raw temperature and conductivity data from the first nine scans of the XCTD data were deleted and data considerably deeper than depth range of the manufacturer's specifications and spikes were manually removed.
2. Missing data by the above editing was linearly interpolated when the data gap was within 15 scans (about 2 m).
3. Temperature and conductivity data were low-pass filtered (running mean with a window of 15 scans).
4. The conductivity data was advanced for 1.5 scans (about 0.2 m), instead of 2 scans described in Uchida and Imawaki (2008), relative to the temperature data to correct mismatch of response time of the sensors.
5. Pressure was estimated from depth and location (latitude) by calculating backward from a pressure to depth conversion equation (Saunders and Fofonoff, 1976), and salinity was calculated from the pressure, temperature and conductivity data by using the reference conductivity of $42.896 \text{ mS cm}^{-1}$ at salinity of 35, temperature of $15 \text{ }^\circ\text{C}$ (IPTS-68) and pressure of 0 dbar. The reference conductivity value is used in the manufacturer's data processing software.
6. The data were sampled at 1-dbar interval.
7. Salinity biases of the XCTD data were estimated by using tight relationship between temperature and salinity in the deep ocean. At in situ temperature of $2.75 \text{ }^\circ\text{C}$, mean salinity was 34.399 (SD, 0.006) and mean pressure was 993 dbar (SD, 53 dbar) for the CTD data obtained at four stations (P01_40, 44, 58, and 60). Difference between XCTD salinity and the mean CTD salinity at temperature of $2.75 \text{ }^\circ\text{C}$ was considered to be salinity bias of the XCTD data (Table 2.6.1). For the XCTD data of the station P01_51, salinity bias could not be estimated because the maximum depth was too shallow to estimate the salinity bias.

(5) Results

Vertical sections of potential temperature and salinity are shown in Fig. 2.6.1 combining with CTD data obtained at four stations (P01_40, 44, 58, and 60). Relationship between potential temperature

and salinity is also shown in Fig. 2.6.2.

Table 2.6.1 Salinity offset correction value to the XCTD salinity data. Ship intake temperature (SST) and salinity (SSS), and maximum pressure for the XCTD data are also shown.

Station	Serial number	SST [°C]	SSS [PSU]	Max. pressure [dbar]	Salinity offset [PSU]
P01_41	03022140	10.725	32.974	1045	0.009
P01_42	02121625	10.580	32.857	1044	0.015
P01_43	02121627	10.048	32.835	1044	0.028
P01_45	03022141	9.656	32.801	1045	0.033
P01_46	03022142	9.676	32.858	1044	0.010
P01_47	03022176	9.892	32.858	1044	0.010
P01_48	03022171	9.988	32.840	1044	0.024
P01_49	03022174	10.116	32.794	1043	0.027
P01_50	03022172	10.074	32.782	1044	0.005
P01_51	03022170	10.000	32.798	484	-
P01_52	03022149	10.100	32.739	1045	0.015
P01_53	03022148	10.293	32.755	1045	0.031
P01_54	03022146	10.774	32.756	1045	0.024
P01_55	03022152	10.788	32.719	1045	0.026
P01_56	03022147	10.858	32.735	1045	0.025
P01_57	03022151	11.579	32.797	1045	0.010
P01_59	03022144	11.560	32.770	1044	0.014

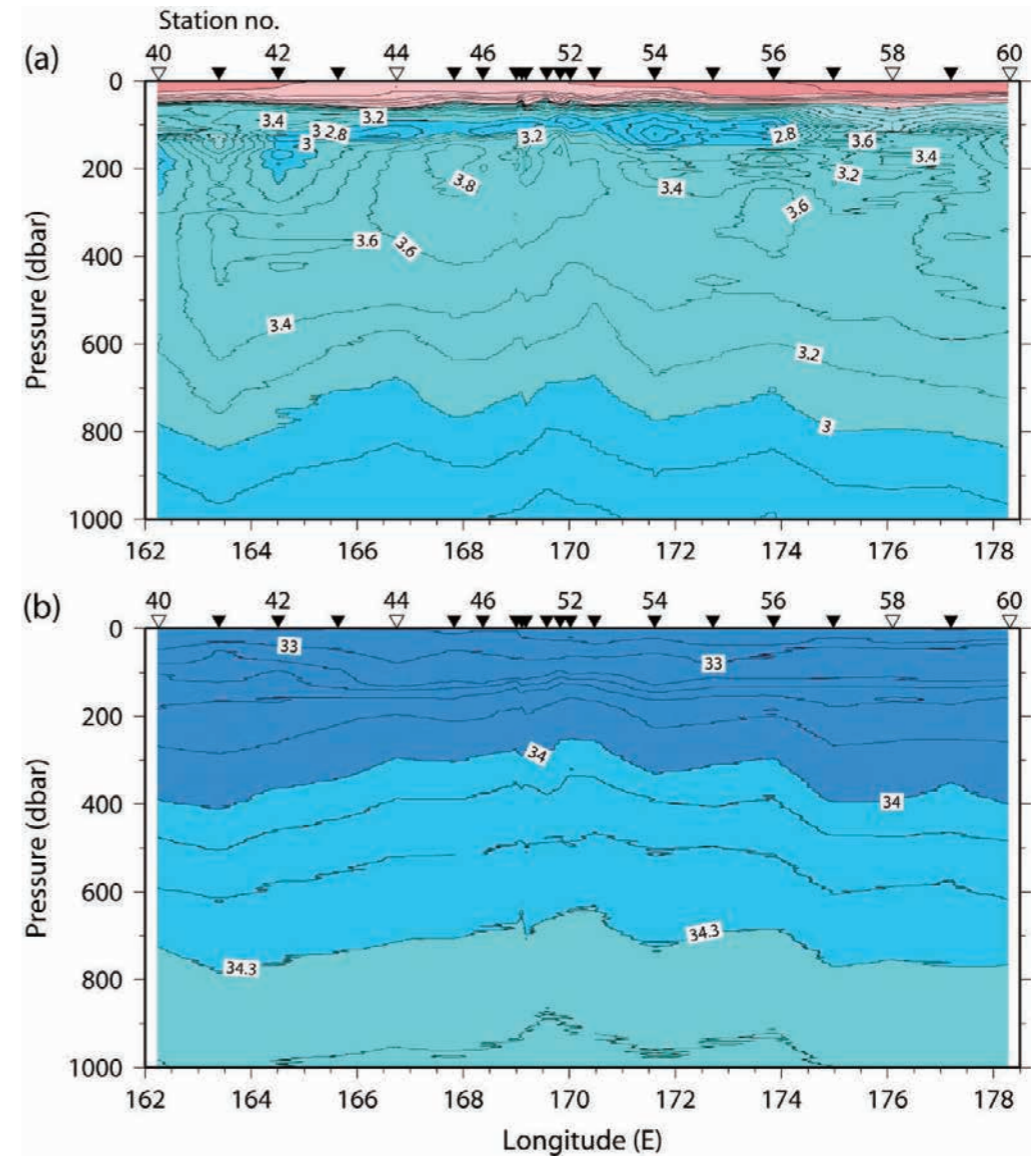

Fig. 2.6.1 Vertical section of (a) potential temperature and (b) salinity. Filled triangles (open triangles) show station locations for the XCTD (CTD) measurements.

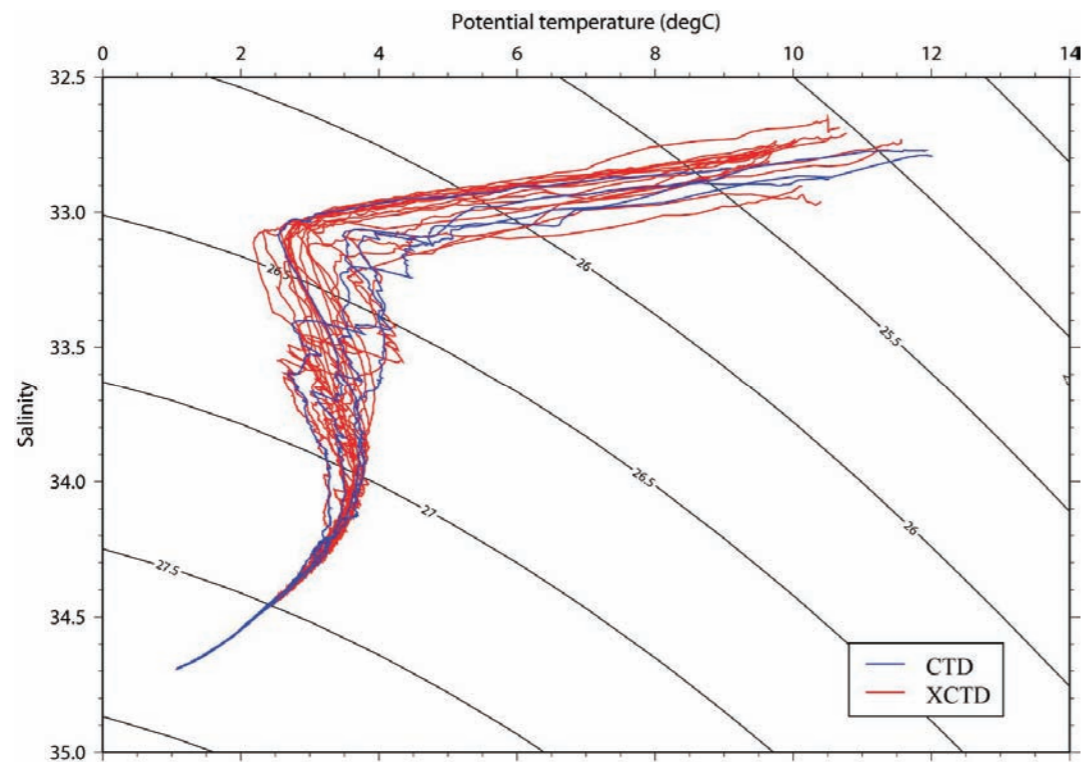

Fig. 2.6.2 Potential temperature plotted against salinity for the XCTD (red curves) and CTD (blue curves) data obtained from station P01_40 to 60.

(6) Data format

Data format for the XCTD data is basically based on WOCE Exchange Format for the CTD data. Quality flags were set to “1” for the XCTD data except for the offset corrected salinity data for which quality flags were set to “2”. Temperature and salinity profiles near the sea surface were filled with the shallowest values and the quality flags were set to “7”.

References

Saunders, P. M. and N. P. Fofonoff (1976): Conversion of pressure to depth in the ocean. *Deep-Sea Res.*, 23, 109-111.

Uchida, H. and S. Imawaki (2008): Estimation of the sea level trend south of Japan by combining satellite altimeter data with in situ hydrographic data. *J. Geophys. Res.*, 113, C09035, doi:10.1029/2008JC004796.

3.1 CTD/O₂ Measurements

11 December 2008

(1) Personnel

Hiroshi Uchida (JAMSTEC)

Satoshi Ozawa (MWJ) (MR07-04_1 and MR07-06_2)

Hirokatsu Uno (MWJ) (MR07-04_1 and MR07-06_2)

Tomoyuki Takamori (MWJ) (MR07-04_1 and MR07-06_2)

Kenichi Katayama (MWJ) (MR07-04_1 and MR07-06_1)

Hiroshi Matsunaga (MWJ) (MR07-06_1)

Kentaro Ohyama (MWJ) (MR07-06_1)

Shinsuke Toyoda (MWJ) (MR07-06_1)

Tsutomu Fujii (MWJ) (MR07-06_2)

(2) Winch arrangements

The CTD package was deployed by using 4.5 Ton Traction Winch System (Dynacon, Inc., Bryan, Texas, USA), which was installed on the R/V Mirai in April 2001 (Fukasawa et al., 2004). Primary system components include a complete CTD Traction Winch System with up to 8000 m of 9.53 mm armored cable (Ocean Cable and Communications Co., Yokohama, Kanagawa, Japan).

(3) Overview of the equipment

The CTD system was SBE 911plus system (Sea-Bird Electronics, Inc., Bellevue, Washington, USA). The SBE 911plus system controls 36-position SBE 32 Carousel Water Sampler. The Carousel accepts 12-litre Niskin-X water sample bottles (General Oceanics, Inc., Miami, Florida, USA). The SBE 9plus was mounted horizontally in a 36-position carousel frame. SBE's temperature (SBE 3) and conductivity (SBE 4) sensor modules were used with the SBE 9plus underwater unit. The pressure

sensor is mounted in the main housing of the underwater unit and is ported to outside through the oil-filled plastic capillary tube. A modular unit of underwater housing pump (SBE 5T) flushes water through sensor tubing at a constant rate independent of the CTD's motion, and pumping rate (3000 rpm) remain nearly constant over the entire input voltage range of 12-18 volts DC. Flow speed of pumped water in standard TC duct is about 2.4 m/s. Two sets of temperature and conductivity modules were used. An SBE's dissolved oxygen sensor (SBE 43) was placed between the primary conductivity sensor and the pump module. Auxiliary sensors, a Deep Ocean Standards Thermometer (SBE 35), an altimeter (PSA-916T; Teledyne Benthos, Inc., North Falmouth, Massachusetts, USA), an oxygen optode (Oxygen Optode 3830; Aanderaa Data Instruments AS, Bergen, Norway), and a fluorometer (Seapoint sensors, Inc., Kingston, New Hampshire, USA) were also used with the SBE 9plus underwater unit. In addition, two prototypes of oxygen optode (RINKO; Alec Electronics Co. Ltd., Kobe, Hyogo, Japan) were also used. To minimize motion of the CTD package, a heavy stainless frame (total weight of the CTD package without sea water in the bottles is about 1000 kg) was used with an aluminum plate (54 × 90 cm: see Fig. 3.1.1 in Kawano and Uchida, 2007).

Summary of the system used in the cruises MR07-04 and MR07-06

Deck unit:

SBE 11plus, S/N 0272

Under water unit:

SBE 9plus, S/N 79492 (Pressure sensor: S/N 0575)

Temperature sensor:

Primary

SBE 3plus, S/N 4216 (stations from P01_1_1 to P01_44_1)

SBE 3plus, S/N 4188 (stations from P01_58_1 to P01_115_1)

(stations from P01_28_2 to P14N_4_1)

SBE 3, S/N 1525 (stations from P14N_30_1 to P14C_1_1)

Secondary

SBE 3, S/N 1464 (stations from P01_1_1 to P01_29_1)

SBE 3, S/N 1525 (stations from P01_40_1 to P01_115_1)
(stations from P01_28_2 to P14N_4_1)

SBE 3plus, S/N 4421 (stations from P14N_30_1 to P14N_33_1)

SBE 3plus, S/N 4188 (stations from P14N_34_1 to P14N_73_1)

SBE 3plus, S/N 4216 (stations from P14N_75_1 to P14C_1_1)

* without secondary temperature sensor for station P14N_74_2

Conductivity sensor:

Primary

SBE 4, S/N 1203 (stations from P01_1_1 to P01_10_1)

SBE 4, S/N 3064 (stations from P01_11_1 to P01_115_1)
(stations from P01_28_2 to P14N_74_1)

SBE 4, S/N 1206 (stations from P14N_74_2 to P14N_99_1)

SBE 4, S/N 3116 (stations from P14N_100_1 to P14N_109_1)

SBE 4, S/N 3124 (stations from P14N_109_2 to P14C_1_1)

Secondary

SBE 4, S/N 2854 (stations from P01_1_1 to P01_115_1)

SBE 4, S/N 2240 (stations from P01_28_2 to P01_46_1)

SBE 4, S/N 3036 (stations from P01_47_1 to P14N_51_1)

SBE 4, S/N 2854 (stations from P14N_52_1 to P14N_74_1)

SBE 4, S/N 2435 (stations from P14N_80_1 to P14N_171_1)

SBE 4, S/N 1172 (stations from P14N_172_1 to P14C_1_1)

* without secondary conductivity sensor for stations from P14N_74_2 to P14N_79_1

Oxygen sensor:

SBE 43, S/N 0949 (stations from P01_1_1 to P01_115_1)

SBE 43, S/N 0394 (stations from P01_28_2 to P14C_1_1)

AANDERAA Oxygen Optode 3830, S/N 612

ALEC Oxygen Optode (RINKO, prototype I) (stations from P01_1_1 to P01_115_1)
(stations from P01_28_2 to P14N_182_1)

ALEC Oxygen Optode (RINKO, prototype II) (stations from P14N_109_2 to P14C_1_1)

Pump:

Primary

SBE 5T, S/N 4598 (stations P01_1_1 to P01_58_2)

SBE 5T, S/N 4595 (stations P01_60_1 to P01_115_1)
(stations P01_28_2 to P14C_1_1)

Secondary

SBE 5T, S/N 4595 (stations P01_1_1 to P01_58_2)

SBE 5T, S/N 4598 (stations P01_60_1 to P01_115_1)
(stations P01_28_2 to P14C_1_1)

Altimeter:

PSA-916T, S/N 1157

Deep Ocean Standards Thermometer:

SBE 35, S/N 0045

Fluorometer:

Seapoint Sensors, Inc., S/N 2579

* without fluorometer for the following stations,

because the maximum pressure was beyond the pressure-proof

stations from P01_9_1 to P01_12_1,

from P01_44_2 to P01_46_1,

from P01_53_1 to P01_54_1,

from P14N_24_1 to P14N_23_1,

from P14N_100_1 to P14N_101_1,
from P14N_107_1 to P14N_109_2,
and P14N_123_1

Carousel Water Sampler:

SBE 32, S/N 0391

Water sample bottle:

12-litre Niskin-X (no TEFLON coating)

(4) Pre-cruise calibration

i. Pressure

The Paroscientific series 4000 Digiquartz high pressure transducer (Model 415K-187; Paroscientific, Inc., Redmond, Washington, USA) uses a quartz crystal resonator whose frequency of oscillation varies with pressure induced stress with 0.01 per million of resolution over the absolute pressure range of 0 to 15000 psia (0 to 10332 dbar). Also, a quartz crystal temperature signal is used to compensate for a wide range of temperature changes at the time of an observation. The pressure sensor has a nominal accuracy of 0.015% FS (1.5 dbar), typical stability of 0.0015% FS/month (0.15 dbar/month), and resolution of 0.001% FS (0.1 dbar). Since the pressure sensor measures the absolute value, it inherently includes atmospheric pressure (about 14.7 psi). SEASOFT subtracts 14.7 psi from computed pressure automatically.

Pre-cruise sensor calibrations for linearization were performed at SBE, Inc.

S/N 0575, 27 October 1999

The time drift of the pressure sensor is adjusted by periodic recertification corrections against a dead-weight piston gauge (Model 480DA, S/N 23906; Bundenberg Gauge Co. Ltd., Irlam, Manchester, UK). The corrections are performed at JAMSTEC, Yokosuka, Kanagawa, Japan by Marine Works Japan Ltd. (MWJ), Yokohama, Kanagawa, Japan, usually once in a year in order to monitor sensor time drift and linearity.

S/N 0575, 5 July 2007

slope = 0.99980507

offset = 2.33363

Result of the pre-cruise pressure sensor calibration against the dead-weight piston gauge is shown in Fig. 3.1.1.

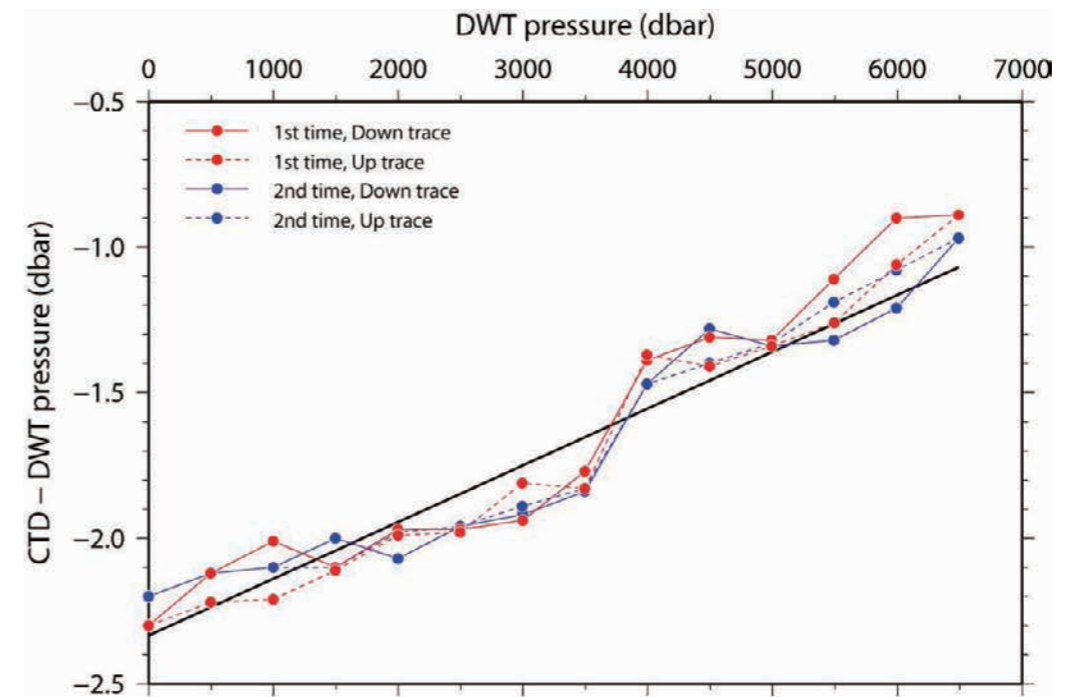

Figure 3.1.1 Difference between the dead-weight piston gauge and the CTD pressure. The calibration line (black line) is also shown.

ii. Temperature (SBE 3)

The temperature sensing element is a glass-coated thermistor bead in a stainless steel tube, providing a pressure-free measurement at depths up to 10500 (6800) m by titanium (aluminum) housing. The SBE 3 thermometer has a nominal accuracy of 1 mK, typical stability of 0.2 mK/month, and resolution of 0.2 mK at 24 samples per second. The premium temperature sensor, SBE 3plus, is a more

rigorously tested and calibrated version of standard temperature sensor (SBE 3).

Pre-cruise sensor calibrations were performed at SBE, Inc.

S/N 4188, 16 May 2007

S/N 4216, 16 May 2007

S/N 1464, 28 June 2007

S/N 1525, 14 June 2007

S/N 4421, 14 June 2007

Pressure sensitivity of SBE 3 was corrected in accordance with a method by Uchida et al. (2007), for the following sensor.

S/N 4188, $-2.946675e-7$ [$^{\circ}\text{C}/\text{dbar}$]

Time drift of the SBE 3 temperature sensors based on the laboratory calibrations is shown in Fig.

3.1.2.

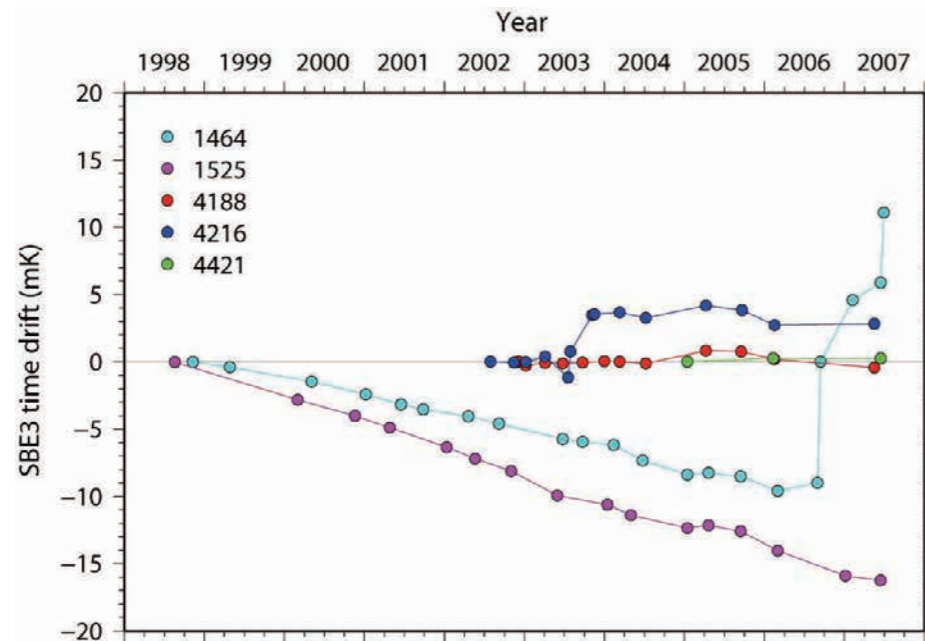

Figure 3.1.2 Time drift of SBE 3 temperature sensors based on laboratory calibrations.

iii. Conductivity (SBE 4)

The flow-through conductivity sensing element is a glass tube (cell) with three platinum electrodes to provide in-situ measurements at depths up to 10500 (6800) m by titanium (aluminum) housing. The SBE 4 has a nominal accuracy of 0.0003 S/m, typical stability of 0.0003 S/m/month, and resolution of 0.00004 S/m at 24 samples per second.

Pre-cruise sensor calibrations were performed at SBE, Inc.

S/N 1203, 14 June 2007

S/N 3064, 14 June 2007

S/N 1088, 14 June 2007

S/N 2240, 10 August 2007

S/N 3036, 10 May 2007

S/N 2854, 10 August 2007

S/N 1206, 10 May 2007

S/N 2435, 10 August 2007

S/N 3116, 16 May 2007

S/N 3124, 16 May 2007

S/N 1172, 14 June 2007

The value of conductivity at salinity of 35, temperature of 15 $^{\circ}\text{C}$ (IPTS-68) and pressure of 0 dbar is 4.2914 S/m.

iv. Oxygen (SBE 43)

The SBE 43 oxygen sensor uses a Clark polarographic element to provide in-situ measurements at depths up to 7000 m. The range for dissolved oxygen is 120% of surface saturation in all natural waters, nominal accuracy is 2% of saturation, and typical stability is 2% per 1000 hours.

Pre-cruise sensor calibrations were performed at SBE, Inc.

S/N 0949, 1 June 2007

S/N 0394, 23 June 2007

v. Deep Ocean Standards Thermometer

Deep Ocean Standards Thermometer (SBE 35) is an accurate, ocean-range temperature sensor that can be standardized against Triple Point of Water and Gallium Melt Point cells and is also capable of measuring temperature in the ocean to depths of 6800 m. The SBE 35 was used to calibrate the SBE 3 temperature sensors in situ (Uchida et al., 2007).

Pre-cruise sensor linearization was performed at SBE, Inc.

S/N 0045, 27 October 2002

Then the SBE 35 is certified by measurements in thermodynamic fixed-point cells of the TPW (0.0100 °C) and GaMP (29.7646 °C). The slow time drift of the SBE 35 is adjusted by periodic recertification corrections. Pre-cruise sensor calibration was performed at SBE, Inc.

S/N 0045, 29 May 2007 (slope and offset correction)

The time required per sample = $1.1 \times \text{NCYCLES} + 2.7$ seconds. The 1.1 seconds is total time per an acquisition cycle. NCYCLES is the number of acquisition cycles per sample and was set to 4. The 2.7 seconds is required for converting the measured values to temperature and storing average in EEPROM.

When using the SBE 911 system with SBE 35, the deck unit receives incorrect signal from the under water unit for confirmation of firing bottle #16. In order to correct the signal, a module (Yoshi Ver. 1; EMS Co. Ltd., Kobe, Hyogo, Japan) was used between the under water unit and the deck unit.

Time drift of the SBE 35 based on the fixed point calibrations is shown in Fig. 3.1.3.

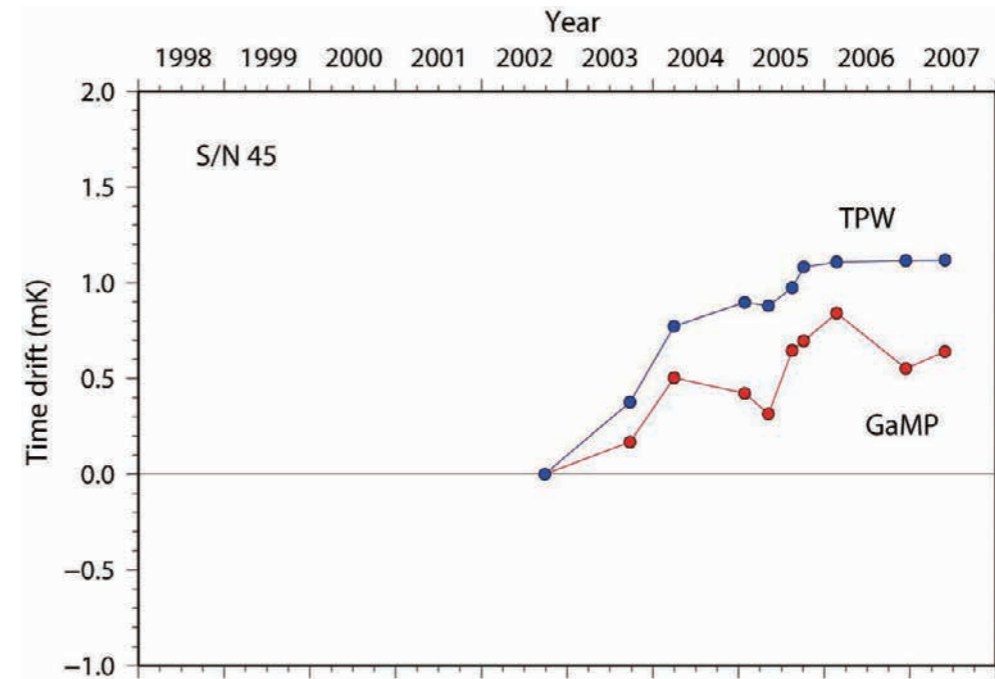

Figure 3.1.3 SBE35 time drift based on laboratory fixed point calibrations (triple point of water, TPW and gallium melt point, GaMP) performed by SBE, Inc.

vi. Altimeter

Benthos PSA-916T Sonar Altimeter (Teledyne Benthos, Inc.) determines the distance of the target from the unit by generating a narrow beam acoustic pulse and measuring the travel time for the pulse to bounce back from the target surface. It is rated for operation in water depths up to 10000 m. The PSA-916T uses the nominal speed of sound of 1500 m/s.

vii. Oxygen Optode

Oxygen Optode 3830 (Aanderaa Instruments AS) is based on the ability of selected substances to act as dynamic fluorescence quenchers. In order to use with the SBE 911plus CTD system, an analog adaptor (3966) is connected to the oxygen optode (3830). The analog adaptor is packed into titanium

housing made by Alec Electronics Co. Ltd., Kobe, Hyogo, Japan. The sensor is designed to operate down to 6000 m. The range for dissolved oxygen is 120% of surface saturation in all natural waters, nominal accuracy is less than 5% of saturation, and setting time (68%) is shorter than 25 seconds.

Outputs from the sensor are the raw phase shift and temperature. The optode oxygen can be calibrated in accordance with a method by Uchida et al. (2008) by using oxygen data obtained from discrete water samples.

viii. Fluorometer

The Seapoint Chlorophyll Fluorometer (Seapoint Sensors, Inc., Kingston, New Hampshire, USA) provides in-situ measurements of chlorophyll-a at depths up to 6000 m. The instrument uses modulated blue LED lamps and a blue excitation filter to excite chlorophyll-a. The fluorescent light emitted by the chlorophyll-a passes through a red emission filter and is detected by a silicon photodiode. The low level signal is then processed using synchronous demodulation circuitry, which generates an output voltage proportional to chlorophyll-a concentration.

ix. Prototype of oxygen optode

The prototype of oxygen optodes (RINKO prototype I and II: Alec Electronics Co. Ltd.) provides the raw phase shift and temperature at depths up to 7000 m. Pre-cruise calibration was not performed for the prototype sensors. The RINKO can also be calibrated in accordance with a method by Uchida et al. (2008) by using oxygen data obtained from discrete water samples.

(5) Data collection and processing

i. Data collection

CTD system was powered on at least 20 minutes in advance of the data acquisition and was powered off at least two minutes after the operation in order to acquire pressure data on the ship's deck.

The package was lowered into the water from the starboard side and held 10 m beneath the surface

for about one minute in order to activate the pump. After the pump was activated, the package was lifted to the surface and lowered at a rate of 1.0 m/s to 200 m (or 300 m when significant wave height is high) then the package was stopped to operate the heave compensator of the crane. The package was lowered again at a rate of 1.2 m/s to the bottom. For the up cast, the package was lifted at a rate of 1.1 m/s except for bottle firing stops. At each bottle firing stops, the bottle was fired after waiting from the stop for 30 seconds and the package was stayed at least 5 seconds for measurement of the SBE 35. At 200 m (or 300 m) from the surface, the package was stopped to stop the heave compensator of the crane.

Water samples were collected using a 36-bottle SBE 32 Carousel Water Sampler with 12-litre Niskin-X bottles. Before a cast taken water for CFCs, the 36-bottle frame and Niskin-X bottles were wiped with acetone.

Data acquisition software

SEASAVE-Win32, version 5.27b

ii. Data collection problems

Temperature sensor

Scattering of difference between the primary temperature sensor S/N 4216 and the SBE 35 was slightly greater than that between the secondary temperature sensor S/N 1464 and the SBE 35. Therefore the temperature sensor S/N 4188 was used as primary temperature sensor after the station P01_44_1.

Scattering of difference between the primary temperature sensor S/N 4188 and the SBE 35 was slightly greater than that between the secondary temperature sensor S/N 1525 and the SBE 35. Therefore the temperature sensor S/N 1525 was used as primary temperature sensor and the temperature sensor S/N 4421 was used as secondary temperature sensor after the station P14N_4_1. The secondary temperature sensor S/N 4421, however, showed large discrepancy (about 0.5 mK) between the down-cast and up-cast. Therefore the secondary temperature sensor was replaced with the temperature sensor S/N 4188 after the station P14N_33_1.

Scattering of difference between the secondary temperature sensor S/N 4188 and the SBE 35 was

gradually became large. Therefore the secondary temperature sensor S/N 4188 was replaced with the temperature sensor S/N 4216 after the station P14N_73_1.

At the stations from P14N_75_1 to P14N_79_1, the secondary temperature sensor was used without the secondary conductivity sensor. The temperature sensor was directly connected with the pump by a tube. Consequently, the temperature sensor reading was about 1 mK higher than usual for the stations from P14N_75_1 to P14N_79_1.

Conductivity sensor

The conductivity sensor reading from the primary conductivity sensor was shifted during the down cast of station P01_7_1, P01_8_1, P01_9_1, and P01_10_1. Therefore the conductivity sensor was replaced after the station P01_10_1.

The secondary conductivity sensor S/N 2240 was broken near the bottom of the station P01_45_1. Therefore the secondary conductivity sensor was replaced with the conductivity sensor S/N 3036 after the station P01_46_1. The secondary conductivity sensor S/N 3036 was broken near the bottom of the station P14N_51_1. Therefore the secondary conductivity sensor was replaced with the conductivity sensor S/N 2854 after the station. The primary and secondary conductivity sensors S/N 3064 and S/N 2854 were broken near the bottom of the station P14N_74_1. Therefore the primary conductivity sensor was replaced with the conductivity sensor S/N 1206 and the secondary temperature and conductivity sensors were removed from the CTD system after the station, and at the station P14N_80_1, the secondary conductivity sensor S/N 2435 was attached to the CTD system. The primary conductivity sensor S/N 3116 was broken near the bottom of the station P14N_108_1. Because the secondary conductivity sensor was in normal condition and the remaining station was only one station for the cruise MR07-06_1, the broken conductivity sensor was left for the station P14N_109_1. At the beginning of the cruise MR07-06_2, the primary conductivity was replaced with the conductivity sensor S/N 3124. The secondary conductivity sensor S/N 2435 was broken near the bottom of the station P14N_171_1. Therefore the secondary conductivity sensor was replaced with the conductivity sensor

S/N 1172 after the station.

Because the conductivity sensor reading from the primary conductivity sensor S/N 1206 was slightly shifted during a long stop due to the winch trouble during the station P14N_98_1, the primary conductivity sensor was replaced with the conductivity sensor S/N 3116 after the station P14N_99_1.

Prototype of oxygen optode

At the station P14N_181_1, the sensor reading from RINKO prototype I was unstable during the down-cast, although the sensor reading was normal during the up-cast. At the station P14N_182_1, RINKO prototype I did not work during the cast due to leakage. Therefore the sensor was removed after the cast.

Winch troubles

At the station P01_34_1, a sensor in the hydraulic actuator of the crane broke at about 864 dbar of the up-cast. Therefore CTD was operated without heave motion of the crane at the station P01_35_1.

At the station P14N_98_1, a chain rotating the cable drum broke at about 713 dbar of the down-cast and the CTD package was stopped at the depth for about 110 minutes during repair.

At the station P14N_178_1, the CTD package rapidly approached the bottom before firing the bottle #1, and the neatly arranged cable on the winch drum broke down in disorder because the CTD package was quickly upped near the bottom. Therefore the cast was quitted. The station location was changed about one mile from the original location and the second cast was carried out.

Miss trip and miss fire

Niskin bottles did not trip correctly at the following stations.

Miss trip	Miss fire
P01_23_1, #15	P14N_60_1, #26
P01_40_2, #10	P14N_71_1, #31

P01_54_1, #10 P14C_35_1, #11
P14N_54_1, #11
P14N_63_1, #11
P14N_64_1, #11
P14N_77_1, #27
P14N_92_1, #24
P14N_99_1, #18
P14N_101_1, #16
P14N_103_1, #5
P14N_107_1, #3 and #12
P14N_110_1, #2
P14N_126_1, #30
P14N_127_1, #28
P14C_50_1, #24
P14C_7_1, #22

Other incidents of note

At station P01_29_1, a longline for fishery was caught in a propeller at about 5000 dbar of the down cast. Therefore the cast was quitted and no water was sampled.

At station P01_58_1, primary temperature signal was lost at 2400 dbar of the down cast. Therefore the cast was quitted and the connection cable was replaced.

At stations P01_81_1, P01_105_1 and P01_111_1, Jellyfish was in secondary T-C duct, and data quality from the secondary temperature and conductivity sensors was bad. The secondary T-C duct was cleaned with Triton-X after the casts.

At station P01_115_1, a fishing boat existed near the planned location. Therefore the station location was changed a little to the north.

At the station P01_47_1, the secondary temperature and conductivity data were noisy.

At the station P14N_55_1, the SBE 35 data of bottle #8 was lost, because the next bottle firing command was sent before storing the SBE 35 data in the internal memory.

At the station P14N_140_1, the secondary salinity data did not change from zero. Therefore the cast was quitted. The secondary sensors were flushed with water and the second cast was carried out.

iii. Data processing

SEASOFT consists of modular menu driven routines for acquisition, display, processing, and archiving of oceanographic data acquired with SBE equipment. Raw data are acquired from instruments and are stored as unmodified data. The conversion module DATCNV uses instrument configuration and calibration coefficients to create a converted engineering unit data file that is operated on by all SEASOFT post processing modules. The following are the SEASOFT and original software data processing module sequence and specifications used in the reduction of CTD data in this cruise.

Data processing software

SEASOFT-Win32, version 5.27b

DATCNV converted the raw data to engineering unit data. DATCNV also extracted bottle information where scans were marked with the bottle confirm bit during acquisition. The duration was set to 4.4 seconds, and the offset was set to 0.0 second.

TCORP (original module, version 1.0) corrected the pressure sensitivity of the SBE 3 for both profile and bottle information data. One SBE 3 (S/N 4188) was corrected because it had relatively large pressure sensitivity (about +1.8 mK per 6000 dbar).

ROSSUM created a summary of the bottle data. The data were averaged over 4.4 seconds.

ALIGNCTD converted the time-sequence of sensor outputs into the pressure sequence to ensure that all calculations were made using measurements from the same parcel of water. For a SBE 9plus CTD with the ducted temperature and conductivity sensors and a 3000-rpm pump, the typical net advance of the conductivity relative to the temperature is 0.073 seconds. So, the SBE 11plus deck unit

was set to advance the primary and the secondary conductivity for 1.73 scans ($1.75/24 = 0.073$ seconds). Oxygen data are also systematically delayed with respect to depth mainly because of the long time constant of the oxygen sensor and of an additional delay from the transit time of water in the pumped plumbing line. This delay was compensated by 6 seconds advancing oxygen sensor output (oxygen voltage) relative to the temperature data. Data from the RINKO prototype I and II were also delayed 2 seconds relative to the temperature data.

ALIGNOPT (original module, version 0.1) also compensated the delay of the AANDERAA optode sensor by advancing relative to the CTD temperature data as a function of temperature (t).

$$\begin{aligned} \text{align (sec)} &= 25 \times \exp(-0.13 \times t) \quad (\text{for } 0 \leq t \leq 16.3 \text{ } ^\circ\text{C}) \\ &= 25 \quad (\text{for } t < 0 \text{ } ^\circ\text{C}) \\ &= 3 \quad (\text{for } t > 16.3 \text{ } ^\circ\text{C}) \end{aligned}$$

WILDEDIT marked extreme outliers in the data files. The first pass of WILDEDIT obtained an accurate estimate of the true standard deviation of the data. The data were read in blocks of 1000 scans. Data greater than 10 standard deviations were flagged. The second pass computed a standard deviation over the same 1000 scans excluding the flagged values. Values greater than 20 standard deviations were marked bad. This process was applied to all variables.

CELLTM used a recursive filter to remove conductivity cell thermal mass effects from the measured conductivity. Typical values used were thermal anomaly amplitude $\alpha = 0.03$ and the time constant $1/\beta = 7.0$.

FILTER performed a low pass filter on pressure with a time constant of 0.15 seconds. In order to produce zero phase lag (no time shift) the filter runs forward first then backwards.

WFILTER performed as a median filter to remove spikes in fluorometer data. A median value was determined by 49 scans of the window.

SECTION (or original module of SECTIONU, version 1.0) selected a time span of data based on scan number in order to reduce a file size. The minimum number was set to be the start time when the CTD package was beneath the sea-surface after activation of the pump. The maximum number was set

to be the end time when the package came up from the surface. Data for estimation of the CTD pressure drift were prepared before SECTION.

LOOPEDIT marked scans where the CTD was moving less than the minimum velocity of 0.0 m/s (traveling backwards due to ship roll).

DESPIKE (original module, version 1.0) removed spikes of the data. A median and mean absolute deviation was calculated in 1-dbar pressure bins for both down- and up-cast, excluding the flagged values. Values greater than 4 mean absolute deviations from the median were marked bad for each bin. This process was performed 2 times for temperature, conductivity, oxygen voltage (SBE 43) and optode oxygen (AANDERAA) data.

DERIVE was used to compute oxygen (SBE 43).

BINAVG averaged the data into 1-dbar pressure bins. The center value of the first bin was set equal to the bin size. The bin minimum and maximum values are the center value plus and minus half the bin size. Scans with pressures greater than the minimum and less than or equal to the maximum were averaged. Scans were interpolated so that a data record exist every dbar.

DERIVE was re-used to compute salinity, potential temperature, and density (σ_θ).

SPLIT was used to split data into the down cast and the up cast.

The shift of the primary conductivity data at stations P01_7_1, P01_8_1, P01_9_1, and P01_10_1 were corrected by using original module SHIFTCORR. The conductivity sensor gradually shifted from 1000 dbar to the following depth of the down cast. Magnitude of the shift at the following depth was estimated and the conductivity data between 1000 dbar and the following depth was linearly corrected.

Station	Maximum depth of the shift	Magnitude of the shift at the maximum depth
P01_7_1	4170 dbar	-0.00003 S/m
P01_8_1	3774 dbar	-0.00001 S/m
P01_9_1	5850 dbar	-0.00002 S/m
P01_10_1	5820 dbar	-0.00004 S/m

For the station P14N_36_1, bad quality data of the primary temperature and conductivity between 37 and 78 dbar of the down-cast were corrected by using original module SWAP. The bad quality data were replaced with the secondary temperature and conductivity data for the depths. Offsets of the secondary temperature and conductivity data relative to the primary temperature and conductivity data at the depths were estimated from the upper and lower data and were subtracted from the secondary data.

For the station P14N_36_1, bad quality data of the SBE43 between the surface and 70 dbar of the down-cast were replaced by the up-cast data of the SBE43.

Remaining spikes in temperature and salinity data were manually eliminated from the 1-dbar-averaged data. The following data gaps over 1-dbar were linearly interpolated with a quality flag of 6.

Station	Pressure (dbar)	Parameters
P01_2_1	348	Salinity
P01_4_1	70	Salinity
P01_5_1	413, 435-440, 456, 475, 485, 485, 503-504	Salinity
P01_12_1	173	Salinity
P01_21_1	826	Salinity
P01_25_1	108, 416	Salinity
P01_70_1	202, 207	Salinity
P01_72_1	384	Salinity
P01_X15_1	480	Salinity
P01_79_1	141	Salinity
P01_82_1	1776-1780	Salinity
P01_84_1	26	Temperature, Salinity
P01_114_1	284-290	Salinity
P01_115_1	20	Salinity

P01_28_2	99	Salinity
P01_33_1	480	Salinity
P01_57_1	73	Salinity
P14N_110_1	300	Temperature
P14N_111_1	139, 199	Temperature
P14N_154_1	201	Temperature
P14N_164_1	627	Salinity
P14N_170_1	1387	Salinity
P14C_10_1	50	Temperature
P14C_10_1	49-50	Salinity
P14C_6_1	1520	Salinity

(6) Post-cruise calibration

i. Pressure

The CTD pressure sensor offset in the period of the cruise was estimated from the pressure readings on the ship deck. For best results the Paroscientific sensor was powered on for at least 20 minutes before the operation. In order to get the calibration data for the pre- and post-cast pressure sensor drift, the CTD deck pressure was averaged over first and last one minute, respectively. Then the atmospheric pressure deviation from a standard atmospheric pressure (14.7 psi) was subtracted from the CTD deck pressure. The atmospheric pressure was measured at the captain deck (20 m high from the base line) and sub-sampled one-minute interval as a meteorological data. Time series of the CTD deck pressure is shown in Fig. 3.1.4.

The CTD pressure sensor offset was estimated from the deck pressure obtained above. Mean of the pre- and the post-casts data over the whole period gave an estimation of the pressure sensor offset from the pre-cruise calibration. Mean residual pressure between the dead-weight piston gauge and the calibrated CTD data at 0 dbar of the pre-cruise calibration was subtracted from the mean deck pressure.

Estimated mean offset of the pressure data is listed in Table 3.1.1. The post-cruise correction of the pressure data is not deemed necessary for the pressure sensor.

Table 3.1.1 Offset of the pressure data. Mean and standard deviation are calculated from time series of the average of the pre- and the post-cast deck pressures.

Cruise	Mean deck pressure	Standard deviation	Residual pressure	Estimated offset
MR07-04_1	0.12 dbar	0.09 dbar	0.06 dbar	0.06 dbar
MR07-06_1	0.11 dbar	0.09 dbar	0.06 dbar	0.05 dbar
MR07-06_2	0.16 dbar	0.17 dbar	0.06 dbar	0.10 dbar

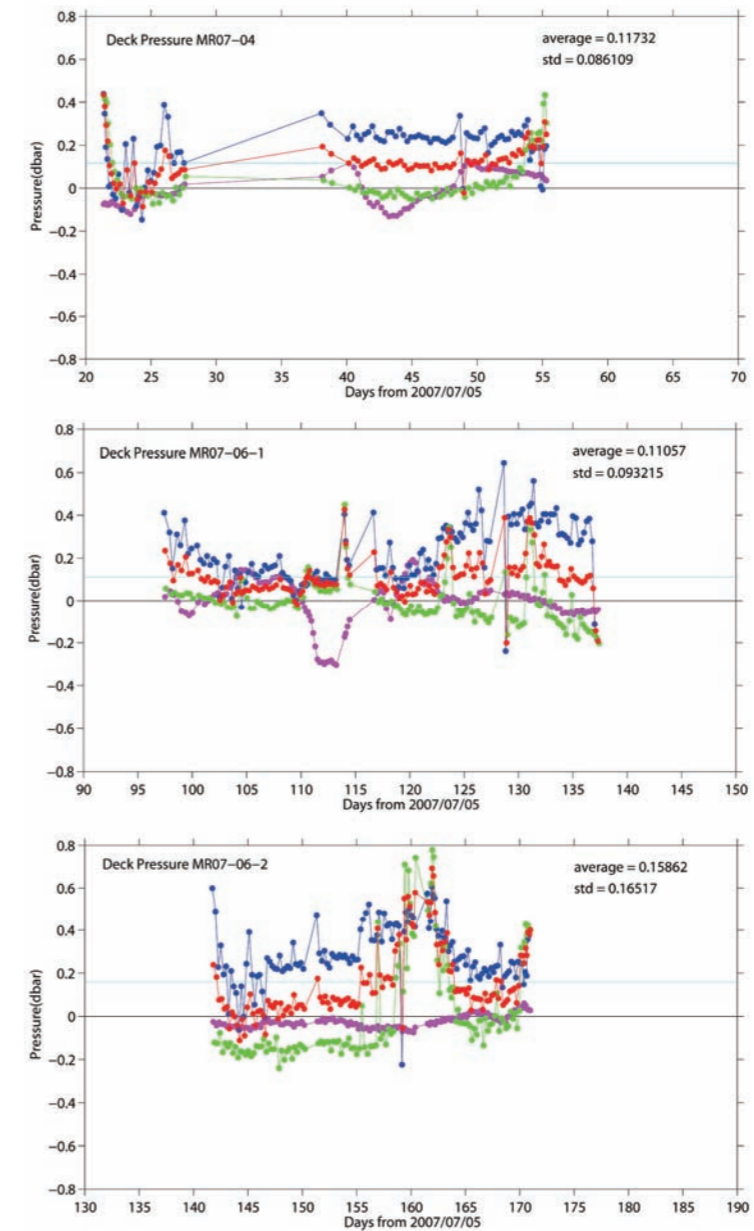

Figure 3.1.4 Time series of the CTD deck pressure. Pink dot indicates atmospheric pressure anomaly. Blue and green dots indicate pre- and post-cast deck pressures, respectively. Red dot indicates an average of the pre- and the post-cast deck pressures.

ii. Temperature

The CTD temperature sensors (SBE 3) were calibrated with the SBE 35 under the assumption that discrepancies between SBE 3 and SBE 35 data were due to pressure sensitivity, the viscous heating effect, and time drift of the SBE 3, in accordance with a method by Uchida et al. (2007).

Post-cruise sensor calibration for the SBE 35 was performed at SBE, Inc.

S/N 0045, 8 February 2008 (2nd step: fixed point calibration)

Slope = 1.000014

Offset = -0.001127

Offset of the SBE 35 data from the pre-cruise calibration was estimated to be smaller than 0.2 mK for temperature smaller than 4.5 °C. So the post-cruise correction of the SBE 35 temperature data was not deemed necessary for the SBE 35.

The CTD temperature was calibrated as

$$\text{Calibrated temperature} = T - (c_0 \times P + c_1 \times t + c_2)$$

where T is CTD temperature in °C, P is pressure in dbar, t is time in days from pre-cruise calibration date of CTD temperature and c_0 , c_1 , and c_2 are calibration coefficients. The coefficients were determined using the data for the depths deeper than 1950 dbar.

The primary temperature data were basically used for the post-cruise calibration. The secondary temperature sensor was also calibrated and used instead of the primary temperature data, because the primary conductivity data was not able to be used for the stations P14N_108_1 and P14N_109_1. The number of data used for the calibration and the mean absolute deviation from the SBE 35 are listed in Table 3.1.2 and the calibration coefficients are listed in Table 3.1.3. The results of the post-cruise calibration for the CTD temperature are summarized in Table 3.1.4 and shown in Figs. 3.1.5 ~ 3.1.7.

Table 3.1.2 Number of data used for the calibration (pressure \geq 1950 dbar) and mean absolute deviation between the CTD temperature and the SBE 35. Serial number 4216 for the cruise MR07-06_1 was secondary temperature sensor.

Cruise	Serial number	Number	Mean absolute deviation	Note
MR07-04_1	4216	382	0.1 mK	Stns. from P01_1_1 to P01_44_1
	4188	760	0.1 mK	Stns. from P01_58_1 to P01_115_1
MR07-06_1	4188	825	0.1 mK	Stns. from P01_28_2 to P14N_4_1
	1525	1210	0.1 mK	Stns. from P14N_30_1 to P14N_109_1
	4216	421	0.1 mK	Stns. from P14N_80_1 to P14N_109_1
MR07-06_2	1525	1528	0.1 mK	

Table 3.1.3 Calibration coefficients for the CTD temperature sensors.

Cruise	Serial number	c_0 (°C/dbar)	c_1 (°C/day)	c_2 (°C)
MR07-04_1	4216	2.02667e-8	-2.25241e-5	0.0027
	4188	4.44381e-8	2.69275e-5	-0.0016
MR07-06_1	4188	3.85600e-8	1.54264e-5	-0.0013
	1525	-6.56477e-9	1.76679e-5	-0.0018
	4216	4.66846e-8	-6.65040e-5	-0.0129
MR07-06_2	1525	8.24860e-9	-1.23300e-5	0.0028

Table 3.1.4 Difference between the CTD temperature and the SBE 35 after the post-cruise calibration.

Mean and standard deviation (Sdev) are calculated for the data below and above 1950 dbar. Number of data used is also shown.

Cruise	Pressure \geq 1950 dbar			Pressure $<$ 1950 dbar		
	Number	Mean (mK)	Sdev (mK)	Number	Mean (mK)	Sdev (mK)
MR07-04_1	1142	0.00	0.1	1589	0.35	12.7
MR07-06_1	1570	0.00	0.2	2962	0.01	6.9
MR07-06_2	2121	0.00	0.1	3007	-0.15	8.4

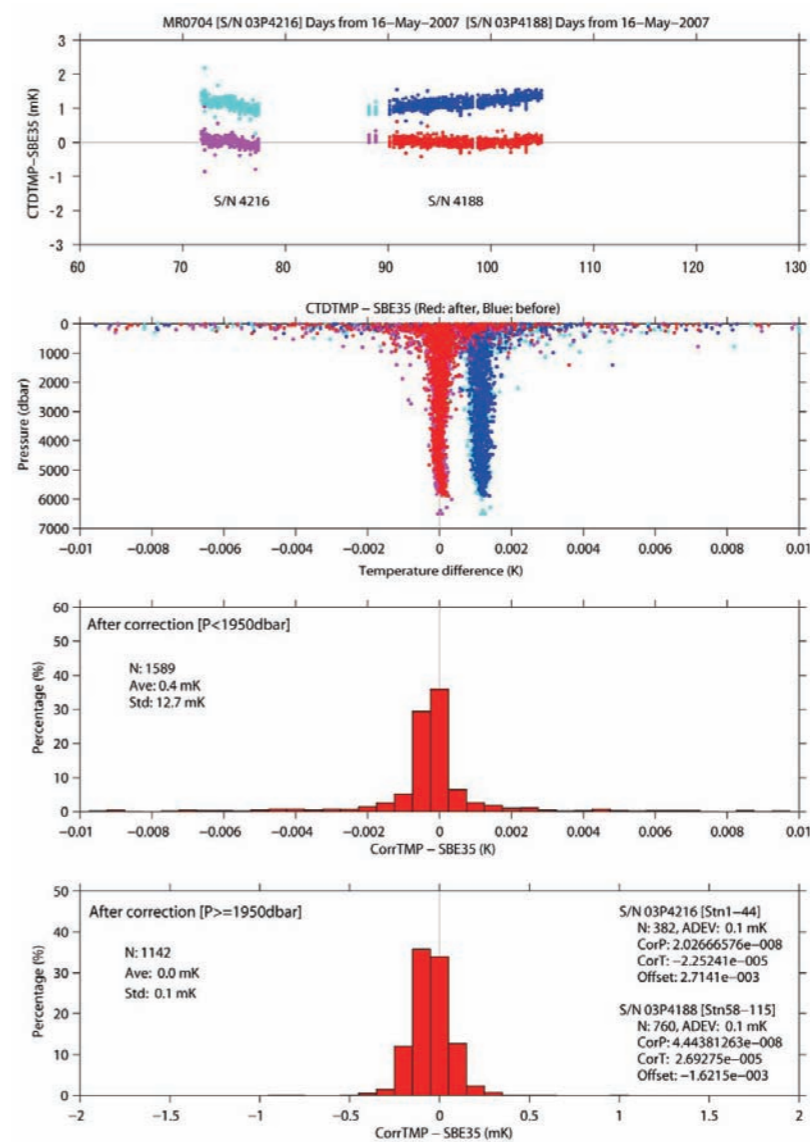

Figure 3.1.5 Difference between the CTD temperature and the SBE 35 for the cruise MR07-04_1.

Blue/cyan and red/magenta dots indicate before and after the post-cruise calibration using the SBE 35 data, respectively. Top panel shows for $P \geq 1950$ dbar. Lower two panels show histogram of the difference after the calibration.

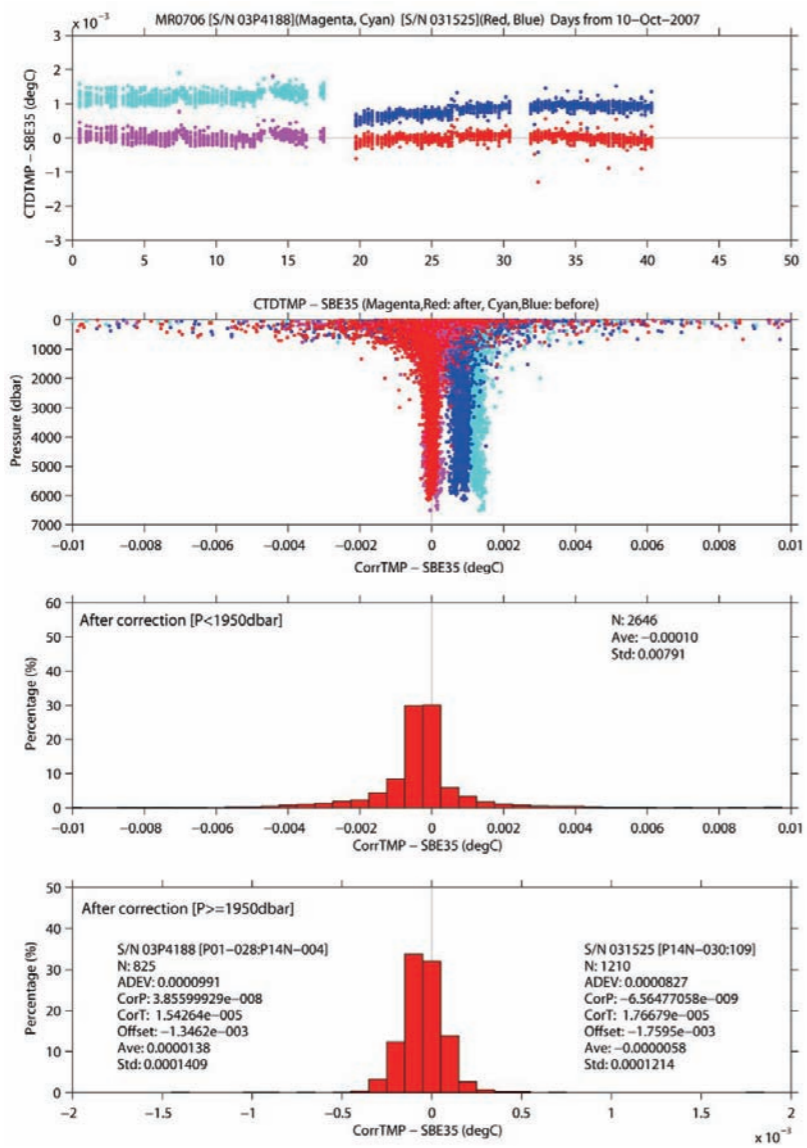

Figure 3.1.6 Same as Fig. 3.1.5, but for the cruise MR07-06_1.

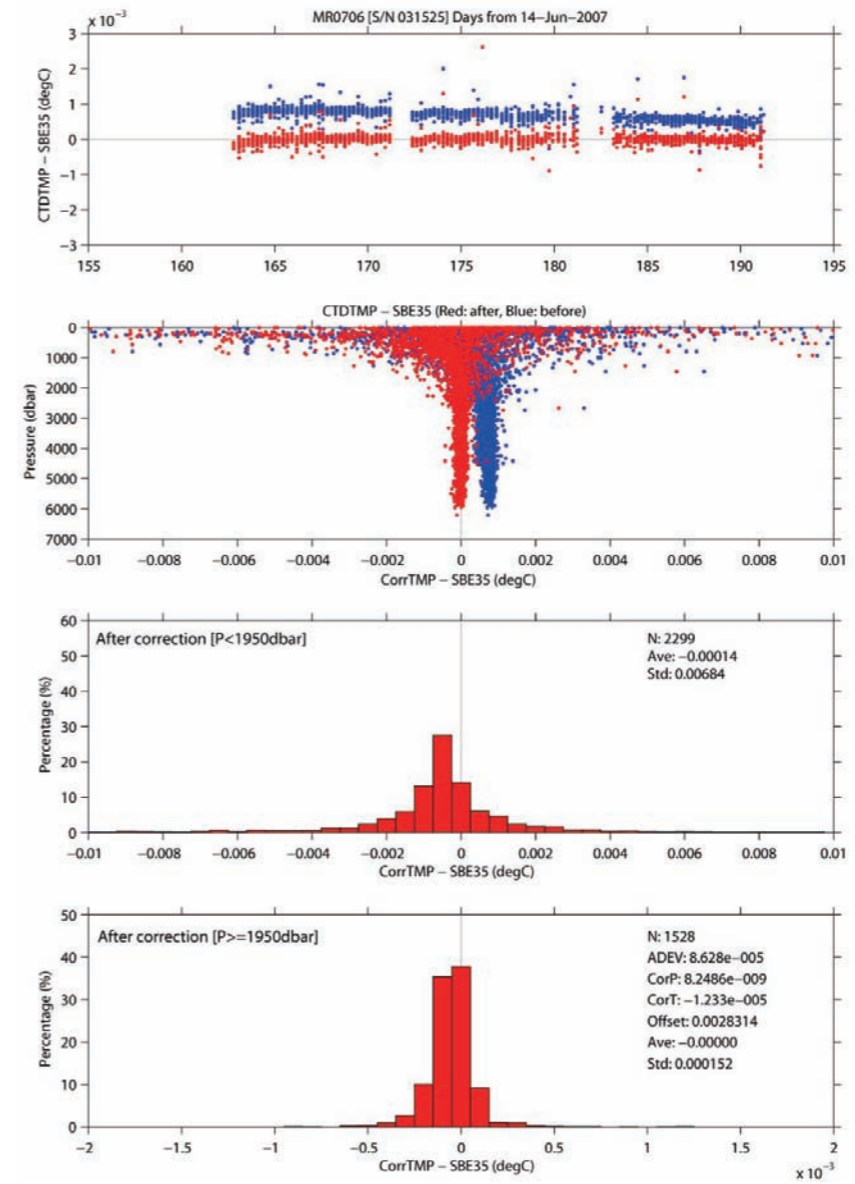

Figure 3.1.7 Same as Fig. 3.1.5, but for the cruise MR07-06_2.

iii. Salinity

The discrepancy between the CTD salinity and the bottle salinity is considered to be a function of conductivity and pressure. The CTD salinity was calibrated as

$$\text{Calibrated salinity} = S - (c_0 \times P + c_1 \times C + c_2 \times C \times P + c_3)$$

where S is CTD salinity, P is pressure in dbar, C is conductivity in S/m and c_0 , c_1 , c_2 and c_3 are calibration coefficients. The best fit sets of coefficients were determined by minimizing the sum of absolute deviation with a weight from the bottle salinity data. The MATLAB[®] function FMINSEARCH was used to determine the sets. The weight was given as a function of vertical salinity gradient and pressure as

$$\text{Weight} = \min[4, \exp\{\log(4) \times \text{Gr} / \text{Grad}\}] \times \min[4, \exp\{\log(4) \times P^2 / \text{PR}^2\}]$$

where Grad is vertical salinity gradient in PSU dbar⁻¹, and P is pressure in dbar. Gr and PR are threshold of the salinity gradient (0.5 mPSU dbar⁻¹) and pressure (1000 dbar), respectively. When salinity gradient is small (large) and pressure is large (small), the weight is large (small) at maximum (minimum) value of 16 (1). The salinity gradient was calculated using up cast CTD salinity data. The up cast CTD salinity data was low-pass filtered with a 3-point (weights are 1/4, 1/2, 1/4) triangle filter before the calculation.

The primary conductivity data created by the software module ROSSUM were basically used after the post-cruise calibration for the temperature data. For the stations P14N_108_1 and P14N_109_1, the secondary conductivity data was used, because the primary conductivity data was not able to be used for the stations. The coefficients were determined for some groups of the CTD stations. The results of the post-cruise calibration for the CTD salinity are summarized in Table 3.1.5 and shown in Figs. 3.1.8 and 3.1.9. And the calibration coefficients and number of data used for the calibration are listed in Table 3.1.6.

Table 3.1.5 Difference between the CTD salinity and the bottle salinity after the post-cruise calibration.

Mean and standard deviation (Sdev) are calculated for the data below and above 950 dbar. Number of data used is also shown.

Cruise	Pressure ≥ 950 dbar			Pressure < 950 dbar		
	Number	Mean	Sdev	Number	Mean	Sdev
MR07-04_1	1494	0.0	0.4	1105	-5.7	19.1
MR07-06_1	2672	0.0	0.4	1870	0.0	4.3
MR07-06_2	2067	-0.1	0.5	1647	1.1	8.8

Table 3.1.6 Calibration coefficients for the CTD salinity. Number of data used is also listed.

Station	Number	c_0	c_1	c_2	c_3
<i>MR07-04_1</i>					
P01_1-28	824	1.0331764015e-5	1.6322214271e-3	-3.1041705576e-6	-5.21792e-3
P01_40-82	845	5.5743728228e-6	-7.5153334807e-3	-1.5802276835e-6	2.33384e-2
P01_83-92	357	-2.6365673251e-6	-1.7948408615e-2	9.9643702860e-7	5.64183e-2
P01_X17-115	568	-6.8043279569e-7	-1.1413741305e-2	3.6019288465e-7	3.54391e-2
<i>MR07-06_1</i>					
P01_28	33	1.2366877766e-5	-3.1864710265e-3	-3.7410180073e-6	8.30924e-3
P01_29	34	1.4429501944e-5	-1.7179786902e-3	-4.3563216655e-6	3.81095e-3
P01_30	33	8.0524469712e-6	-4.6347655243e-3	-2.3595978265e-6	1.29389e-2

P01_32-33	101	1.1753176804e-5	-2.5920297513e-3	-3.5208528038e-6	6.03307e-3
P01_34-41	261	5.2675994458e-6	-4.3909897182e-3	-1.5450824887e-6	1.17190e-2
P01_42-46	216	7.0309692113e-6	-4.3031061185e-3	-2.0723214458e-6	1.08889e-2
P01_47-57	341	1.1092775540e-5	-2.3272648509e-3	-3.3053060435e-6	3.57009e-3
P01_58-59	71	3.2310197116e-6	-4.4057460257e-3	-9.2624113598e-7	1.08304e-2
P01_60-4	826	6.7400531759e-6	-2.7670250955e-3	-1.9631840097e-6	4.12712e-3
P14N_30-39	356	6.2991911918e-6	-1.7666229796e-3	-1.8995982920e-6	1.75626e-3
P14N_40-53	477	5.0547425123e-6	-7.9209509292e-4	-1.5177307189e-6	-1.96119e-3
P14N_54-73	633	3.1759512104e-6	-1.0157437278e-3	-9.4764638711e-7	-1.42327e-3
P14N_74-77	34	2.4469862353e-6	6.4594035205e-4	-7.2598062391e-7	-8.86545e-4
P14N_78-81	133	4.7865965493e-6	1.6054792872e-4	-1.4517360658e-6	-1.54977e-4
P14N_82-99	545	4.3956514692e-7	1.0331301338e-4	-1.1130619565e-7	1.08226e-4
P14N_100-107	271	4.2884569782e-6	-1.7427574735e-3	-1.2594920500e-6	8.51481e-3
P14N_108-109	70	6.0865582513e-6	-4.5049125413e-4	-1.7802113940e-6	2.18567e-3
<i>MR07-06_2</i>					
P14N_109-115	232	2.3777541759e-6	-1.3933958135e-3	-6.6273977628e-7	8.17648e-3
P14N_116-127	417	3.5670485696e-6	-1.1006125106e-3	-1.0346847842e-6	6.86221e-3
P14N_128-138	377	1.3987382078e-6	-1.4065398654e-3	-3.4347529939e-7	7.53518e-3
P14N_139-144	205	2.8354655464e-6	-1.2215836660e-3	-7.9541774815e-7	6.53515e-3
P14N_145-149	170	3.1542072660e-6	-2.0613822363e-3	-8.9077088694e-7	8.87180e-3
P14N_150-158	301	4.8230368910e-6	-1.2147005582e-3	-1.4092637192e-6	5.57979e-3
P14N_159-174	505	1.6174979975e-6	-1.1887433192e-3	-3.8999095831e-7	4.42873e-3
P14N_175-	1484	-1.2626975255e-6	-1.0905094466e-3	5.9573995339e-7	2.43615e-3

P14C_1

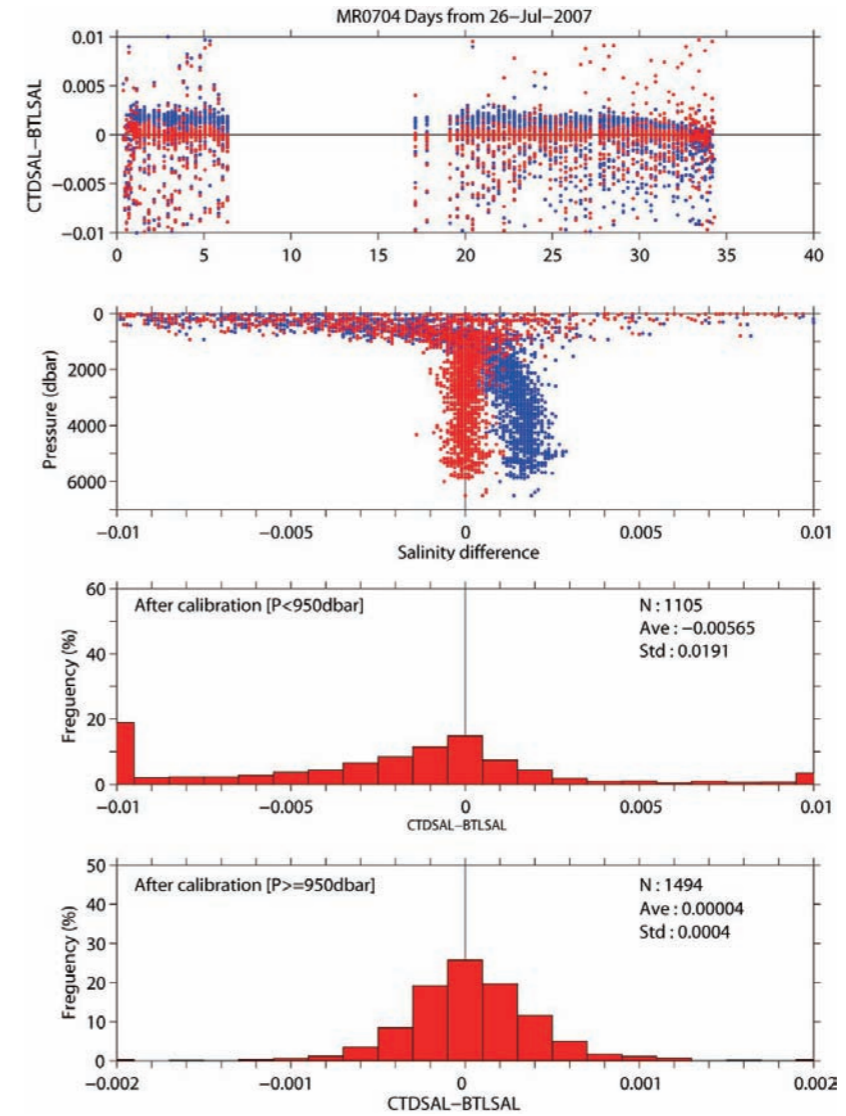

Figure 3.1.8 Difference between the CTD salinity and the bottle salinity for the cruise MR07-04_1. Blue and red dots indicate before and after the post-cruise calibration using the bottle salinity data, respectively. Top panel shows for $P \geq 950$ dbar. Lower two panels show histogram of the difference after the calibration.

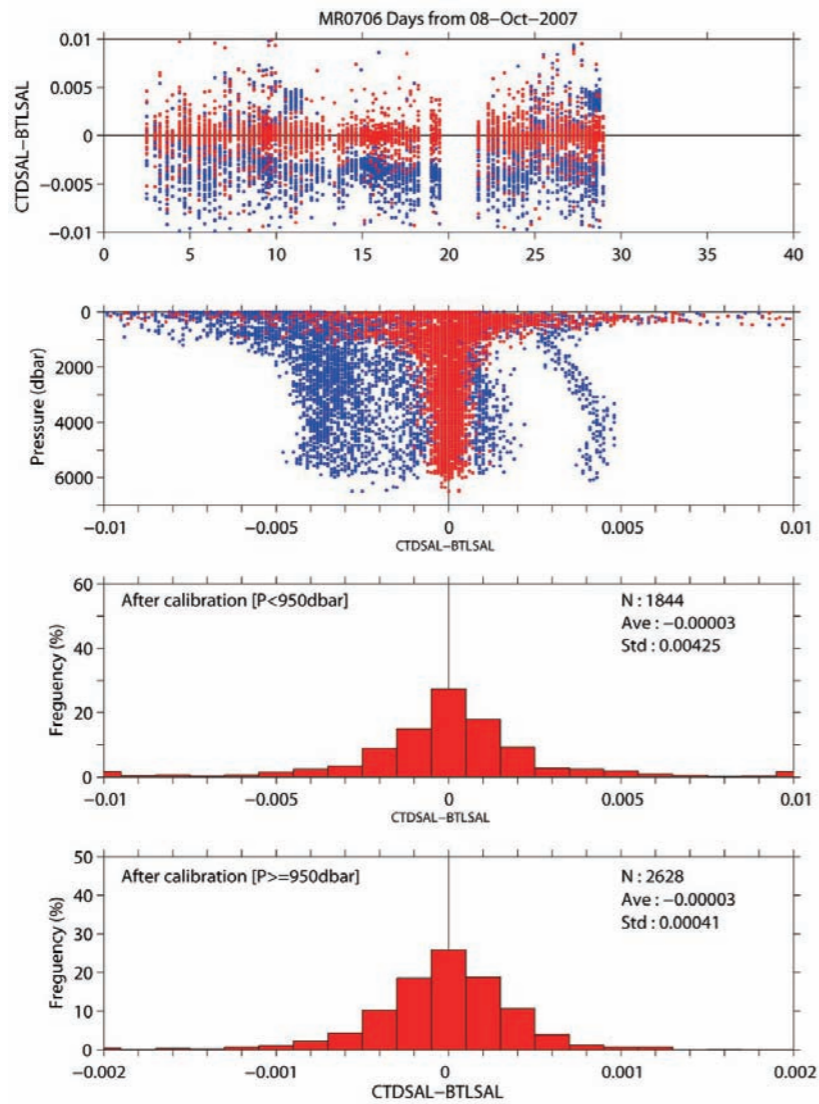

Figure 3.1.9 Same as Fig. 3.1.8, but for the cruise MR07-06_1.

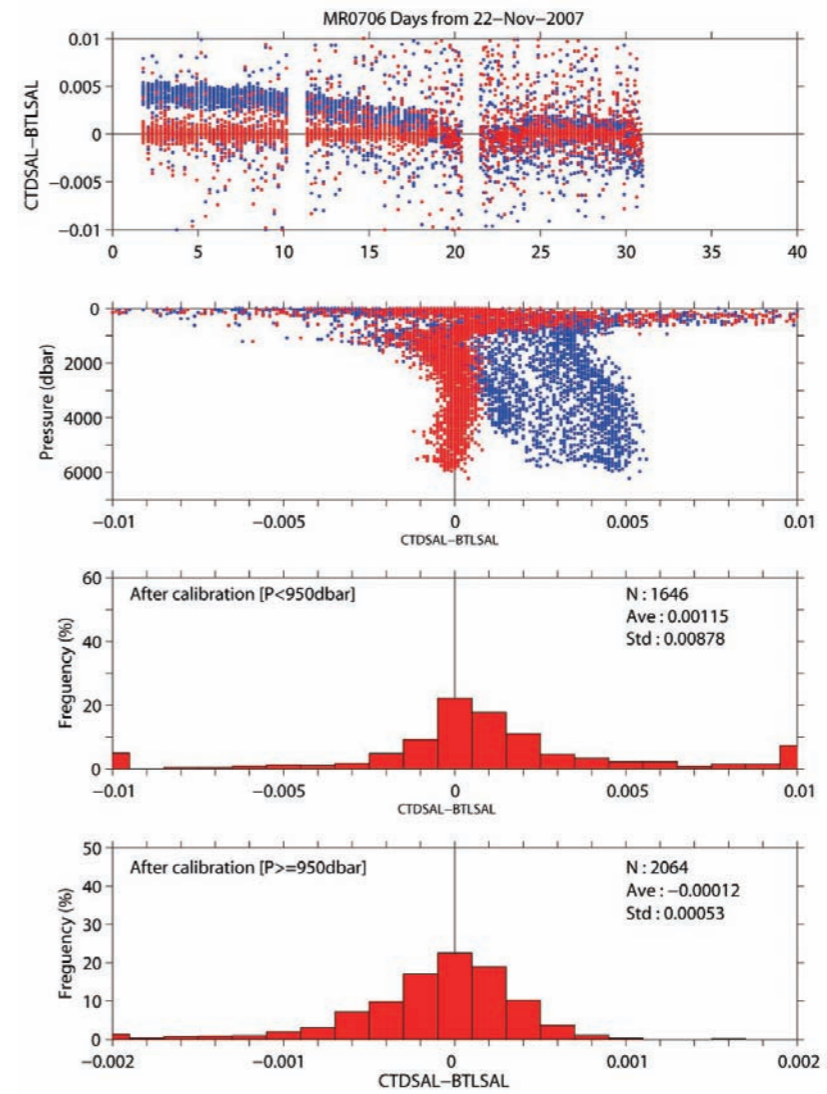

Figure 3.1.10 Same as Fig. 3.1.8, but for the cruise MR07-06_2.

iv. Oxygen (MR07-04)

The AANDERAA and ALEC oxygen optodes were calibrated for the cruise MR07-04.

AANDERAA oxygen optode

The AANDERAA oxygen optode was calibrated by the Stern-Volmer equation, according to a method by Uchida et al. (2008):

$$O_2 (\mu\text{mol/l}) = (P_0 / P - 1) / K_{sv}$$

where P is the phase shift, P₀ is the phase shift in the absence of oxygen and K_{sv} is Stern-Volmer constant. The P₀ and the K_{sv} are assumed to be functions of temperature as follows.

$$K_{sv} = C_{11} + C_{12} \times t + C_{13} \times t^2$$

$$P_0 = C_{21} + C_{22} \times t$$

$$P = C_{31} + C_{32} \times P_b$$

where t is CTD temperature (°C) and P_b is raw phase measurement (deg). The oxygen concentration was calculated using temperature data from the first responding CTD temperature sensor instead of temperature data from slow responding optode temperature sensor.

The calibration was performed for the up cast phase data created by the software module ROSSUM after the post-cruise calibration for the CTD temperature and salinity. The calibration coefficients (C₁₁, C₁₂, C₁₃, C₂₁, C₂₂, C₃₁ and C₃₂) were determined for all CTD stations. The offset (C₃₁) for the phase shift was slightly changed for the 6 groups of CTD casts. The results of the post-cruise calibration for the optode oxygen are summarized in Table 3.1.7 and shown in Fig. 3.1.8. And the calibration coefficients and number of data used for the calibration are listed in Table 3.1.8.

Although the up cast optode data was well calibrated in situ (Fig. 3.1.8), difference between the up and down cast was quite large in the surface layer (~150 dbar) (Fig. 3.1.9). Similar discrepancy was seen in the data obtained in the North Pacific subarctic region (MR06-03_2), and was not seen in the data obtained in the North Pacific subtropical region (MR05-05) (Uchida et al., 2008). Data quality of the in-situ calibrated down cast optode data was bad in the surface layer.

The optode oxygen data from the down cast was about 1 μmol/kg smaller than that from the up cast at depths between 1000 and 3000 dbar (Uchida et al., 2008). Although more work needs to be done on understanding the sensor's response under various situations at ambient temperature and in a vertical gradient of oxygen for more accurate compensation for the profile data, the down cast profile data were empirically corrected by using following equation.

$$O_{2c} = O_2 + 20 \times dO_2 / dp$$

where O₂ is the optode oxygen (μmol/kg) and p is pressure (dbar). For the calculation of the derivative, the oxygen profile was low-pass filtered by using a box-car filter with a window of 5 dbar before the calculation. The results of the correction is shown in Fig. 3.1.10.

Table 3.1.7 Difference between the optode oxygen and the bottle oxygen after the post-cruise calibration.

Mean and standard deviation (Sdev) are calculated for the data below and above 950 dbar. Number of data used is also shown.

Pressure ≥ 950 dbar			Pressure < 950 dbar		
Number	Mean (μmol/kg)	Sdev (μmol/kg)	Number	Mean (μmol/kg)	Sdev (μmol/kg)
1510	0.01	0.31	1118	0.10	2.00

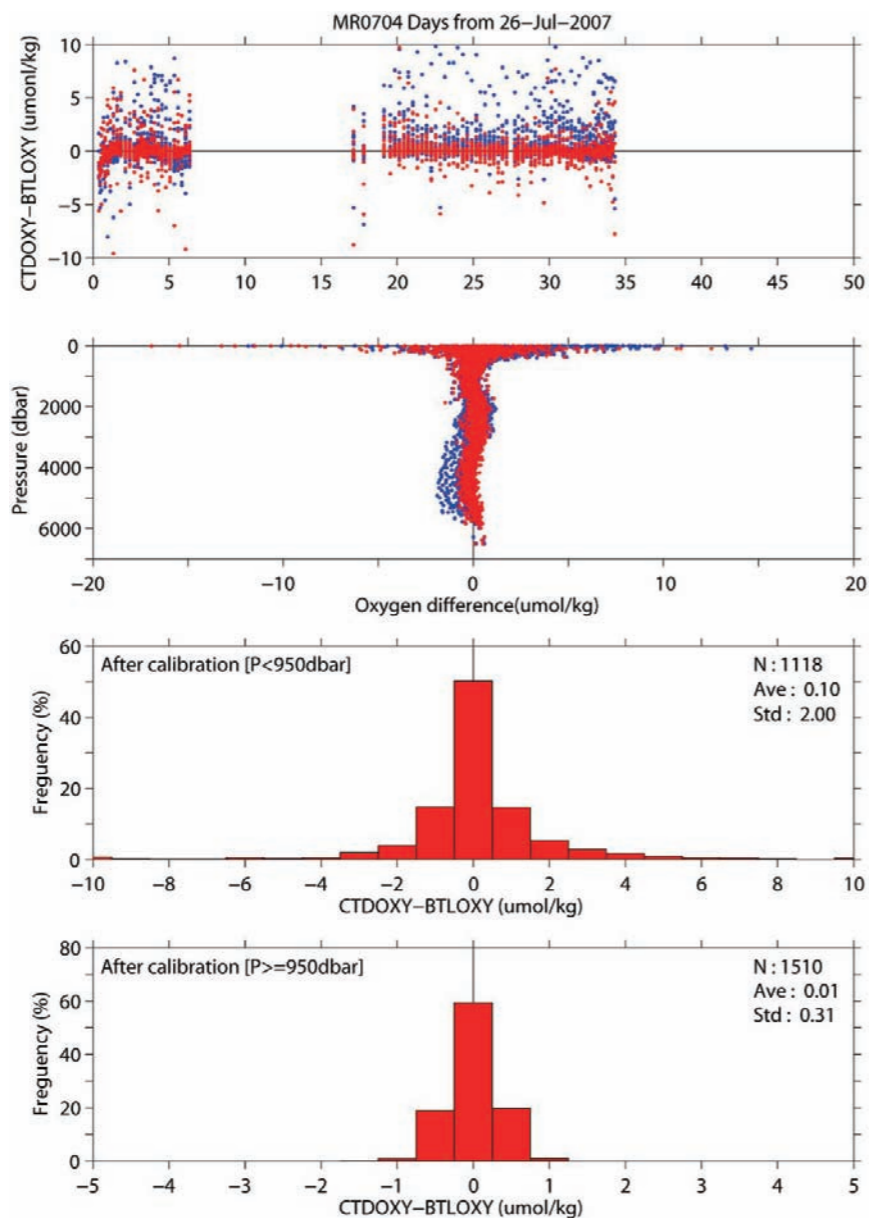

Fig. 3.1.8 Difference between the optode oxygen and the bottle oxygen. Blue and red dots indicate before and after the post-cruise calibration using the bottle salinity data, respectively. Lower two panels show histogram of the difference after the calibration.

Table 3.1.8 Calibration coefficients for the optode oxygen. Number of data used is also listed.

Number	Mean absolute deviation	Coefficients	Group of CTD casts
2627	0.60 $\mu\text{mol/kg}$	$C_{11} = 2.635256348237611\text{e-}03$	
		$C_{12} = 1.225025719497667\text{e-}04$	
		$C_{13} = 1.761916331924197\text{e-}06$	
		$C_{21} = 60.17218865923306$	
		$C_{22} = 8.903986993195000\text{e-}02$	
		$C_{31} = -6.060184746615353$	1_1 – 9_1
		$= -6.004547679479678$	10_1 – 17_1
		$= -6.053733067496423$	18_1 – 23_1
		$= -6.105901740541861$	24_1 – 28_1
		$= -6.018089856760813$	40_1 – 103_1
		$= -6.069381437495752$	104_1 – 115_1
		$C_{32} = 1.090377252560871$	

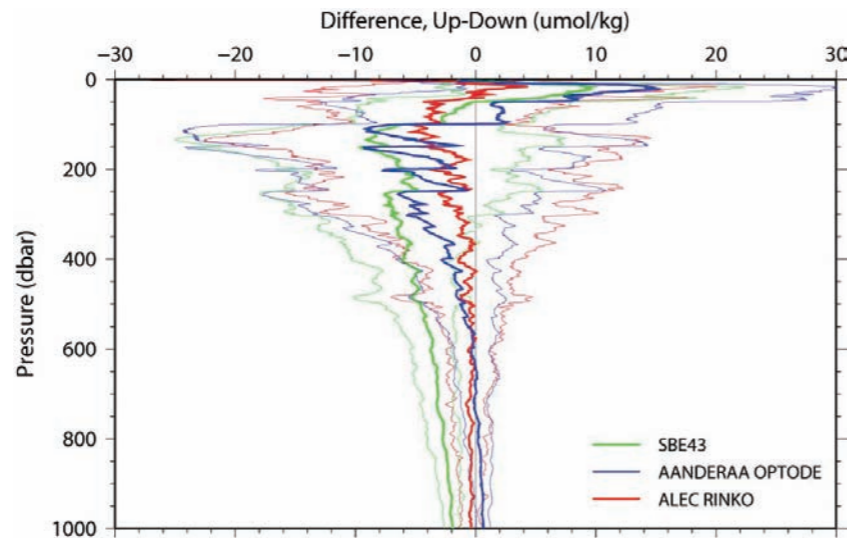

Fig. 3.1.9 Mean oxygen difference between the down and up casts (up-down) for the SBE 43 (green line), the oxygen optode (blue line) and the prototype oxygen optode (red line) obtained from the cruise MR07-04. Thin lines represent 1 standard deviation from the mean profile.

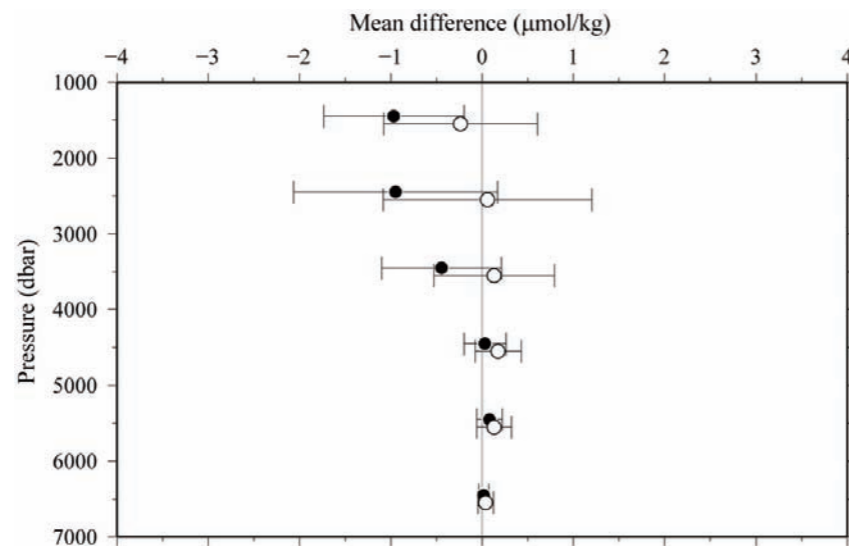

Fig. 3.1.10 Mean oxygen difference between the down and up casts (down-up) for the oxygen optode before (closed circles) and after (open circles) the correction (see text for detail).

ALEC prototype oxygen optode (RINKO)

The prototype of ALEC oxygen optode was calibrated by the Stern-Volmer equation, according to a method by Uchida et al. (2008):

$$O_2 (\mu\text{mol/l}) = (P_0 / P - 1) / K_{sv}$$

where P is the phase shift, P_0 is the phase shift in the absence of oxygen and K_{sv} is Stern-Volmer constant. The P_0 and the K_{sv} are assumed to be functions of temperature as follows.

$$K_{sv} = C_{11} + C_{12} \times t + C_{13} \times t^2$$

$$P_0 = C_{21} + C_{22} \times t$$

$$P = C_{31} + C_{32} \times V$$

where t is CTD temperature ($^{\circ}\text{C}$) and V is raw sensor output (voltage). The response of the sensing foil of the prototype optode decreases with increasing ambient pressure, and this pressure effect was estimated to decrease the response by 2.8 % per 1000 dbar. The oxygen concentration was calculated using temperature data from the first responding CTD temperature sensor instead of temperature data from slow responding optode temperature sensor.

The calibration was performed for the up cast data created by the software module ROSSUM after the post-cruise calibration for the CTD temperature and salinity. The calibration coefficients (C_{11} , C_{12} , C_{13} , C_{21} , C_{22} , C_{31} and C_{32}) were determined for some groups of the CTD stations. The offset (C_{31}) for the phase shift was slightly changed for each CTD cast. The calibration coefficients and number of data used for the calibration are listed in Table 3.1.9. The results of the post-cruise calibration are summarized in Table 3.1.10 and shown in Fig. 3.1.11. In the post-cruise calibration, data depths deeper than 2000 dbar were not used for the first 2 groups (Stns. 1~15 and 16~28) because the calibration coefficients were not well determined when the data were included. Therefore the quality flag of the calibrated oxygen data depths deeper than 2000 dbar were set to 3 for stations from 1 to 28.

Although the up cast optode data was well calibrated in situ (Fig. 3.1.11) and performance in the surface layer was quite well (Fig. 3.1.9), difference between the up and down cast was quite large in the deep layer (depths deeper than 1500 dbar).

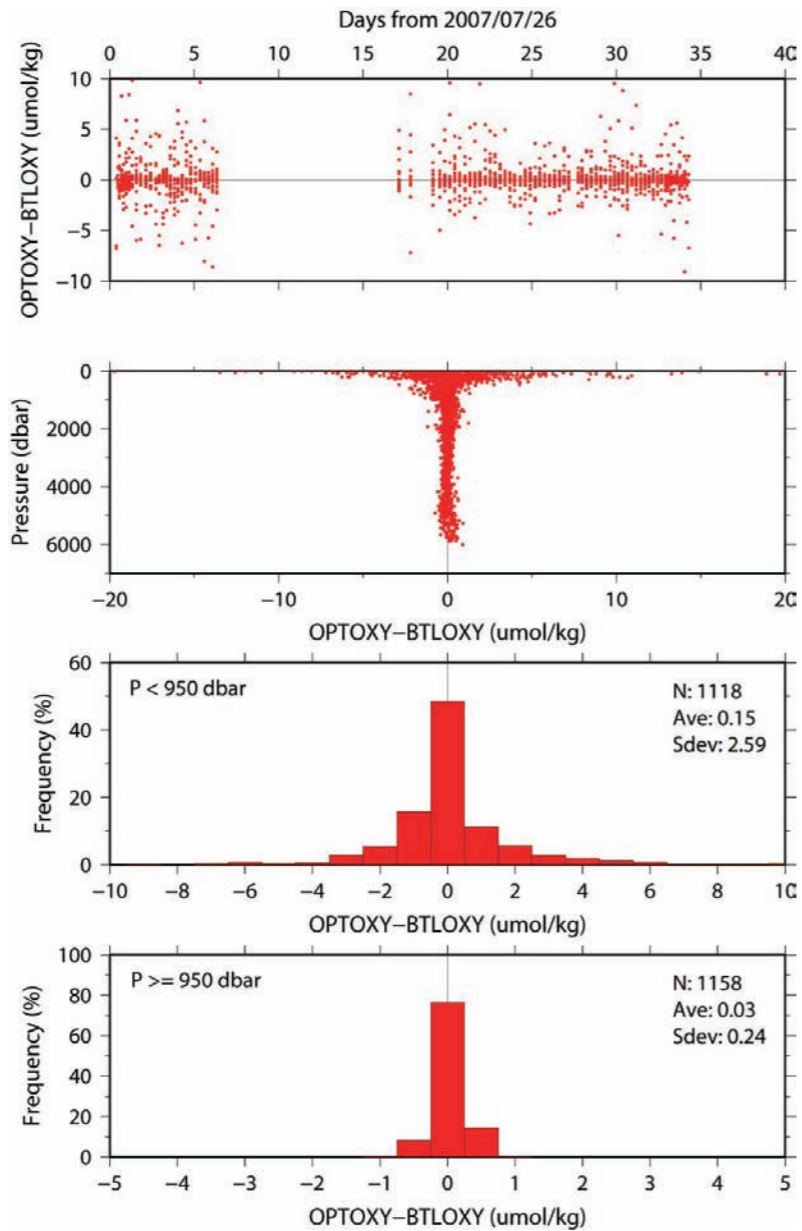

Fig. 3.1.11 Difference between the prototype optode oxygen and the bottle oxygen for after the post-cruise calibration. Top panel shows for $P \geq 950$ dbar. Lower two panels show histogram of the difference.

Table 3.1.9 Calibration coefficients for the prototype of oxygen optode. Number of data (Num) used and mean absolute deviation (Adev) are also listed.

Stn	Num	Adev	C11	C12	C13	C21	C22	C32
1-15	246	1.19	5.8789102e-3	1.3202160e-4	-1.4972252e-6	6.7651313	-8.4590827e-2	1.6812784
16-28	239	1.47	6.0506919e-3	6.2425650e-5	-4.7143030e-7	8.1756988	-1.3633868e-1	2.0311299
40-68	375	0.70	5.3269802e-3	3.1786415e-4	-3.9858532e-6	6.0288515	-2.5233800e-2	1.6248560
69-78	343	0.41	5.1852402e-3	2.5808996e-4	6.0745581e-7	5.7606052	-1.3581176e-2	1.5629738
79-87	336	0.36	5.1906670e-3	2.6273419e-4	5.0734085e-7	5.6164948	-1.1385041e-2	1.5362879
88-97	317	0.54	5.1486342e-3	2.3234328e-4	2.6910529e-7	6.3327141	-2.0598345e-2	1.7236231
98-104	198	0.43	5.2445225e-3	1.9401424e-4	1.4324301e-6	6.0844733	-2.9092447e-2	1.6510633
105-115	221	1.05	5.1940610e-3	2.2635952e-4	1.0836666e-6	7.3620419	-1.6032098e-2	2.0102865

Stn	C31	Stn	C31	Stn	C31	Stn	C31
1	-1.4663410	16	-1.8044790	40	-1.5211045	69	-1.4133193
2	-1.5028371	17	-1.8013574	44	-1.5283612	70	-1.4127655
3	-1.4959721	18	-1.7933317	58	-1.5244686	71	-1.4092531
4	-1.4995386	19	-1.7848185	60	-1.5257361	72	-1.4092409
5	-1.4968510	20	-1.7851197	61	-1.5231930	73	-1.4070984
6	-1.5046124	21	-1.7818728	62	-1.5239379	74	-1.4079670
7	-1.4828724	22	-1.7922501	63	-1.5199569	X15	-1.4055382
8	-1.4845656	23	-1.7746797	64	-1.5214495	76	-1.4020200
9	-1.4752667	24	-1.7617735	65	-1.5190013	77	-1.4060858
10	-1.4907149	25	-1.7543922	66	-1.5220141	78	-1.4020048
11	-1.4728418	26	-1.7486554	67	-1.5200137		
12	-1.4852094	27	-1.7497571	68	-1.5197691		
13	-1.4586884	28	-1.7557400				
14	-1.4565111						
15	-1.4541353						

Stn	C31	Stn	C31	Stn	C31	Stn	C31
79	-1.4005308	88	-1.5249214	98	-1.4498959	105	-1.7497139
80	-1.4002417	89	-1.5217801	99	-1.4473812	106	-1.7474551
81	-1.3991096	90	-1.5212776	100	-1.4476825	107	-1.7506227
82	-1.3983053	91	-1.5184959	101	-1.4488230	108	-1.7414919
83	-1.3970340	92	-1.5172182	102	-1.4451071	109	-1.7450724
84	-1.3965286	X17	-1.5150712	103	-1.4435156	110	-1.7421465
85	-1.3945384	94	-1.5141203	104	-1.4391912	111	-1.7338304
86	-1.3943334	95	-1.5103182			112	-1.7424335
X16	-1.3928051	96	-1.5127131			113	-1.7349491
87	-1.3923077	97	-1.5110558			114	-1.7298328
						115	-1.7540911

Table 3.1.10 Difference between the prototype optode oxygen and the bottle oxygen after the post-cruise calibration. Mean and standard deviation (Sdev) are calculated for the data below and above 950 dbar. Number of data used is also shown.

Pressure \geq 950 dbar			Pressure < 950 dbar		
Number	Mean ($\mu\text{mol/kg}$)	Sdev ($\mu\text{mol/kg}$)	Number	Mean ($\mu\text{mol/kg}$)	Sdev ($\mu\text{mol/kg}$)
1158	0.03	0.24	1118	0.15	2.59

Combined use of the two optode oxygen data

Final CTD oxygen data were produced by combining the two optode oxygen data, because the data quality of the down cast data for the AANDERAA oxygen optode was bad in the surface layer and for the ALEC prototype oxygen optode was bad in the deep layer. The combined oxygen O in $\mu\text{mol/kg}$ was calculated as follows:

$$\begin{aligned}
 O &= O_1 \quad (\text{for } P \leq 800 \text{ dbar}) \\
 &= O_2 \quad (\text{for } P \geq 1000 \text{ dbar}) \\
 &= W_1 \times O_1 + W_2 \times O_2 \quad (\text{for } 800 \text{ dbar} < P < 1000 \text{ dbar}) \\
 W_1 &= (1000 - P) / (1000 - 800) \\
 W_2 &= 1 - W_1
 \end{aligned}$$

where O_1 is the ALEC prototype optode oxygen in $\mu\text{mol/kg}$, O_2 is the AANDERAA optode oxygen in $\mu\text{mol/kg}$, and P is pressure. The comparisons between the combined optode oxygen and the bottle oxygen are summarized in Table 3.1.11.

Table 3.1.11 Difference between the combined optode oxygen and the bottle oxygen after the post-cruise calibration. Mean and standard deviation (Sdev) are calculated for the data below and above 950 dbar. Number of data used is also shown.

Pressure \geq 950 dbar			Pressure < 950 dbar		
Number	Mean ($\mu\text{mol/kg}$)	Sdev ($\mu\text{mol/kg}$)	Number	Mean ($\mu\text{mol/kg}$)	Sdev ($\mu\text{mol/kg}$)
1510	0.01	0.31	1118	0.15	2.59

v. Oxygen (MR07-06)

The SBE 43 oxygen sensor was calibrated for the cruise MR07-06 as follows.

$$O_2 [\text{ml/l}] = \text{Soc} \times \{\text{v+offset}\} \times \exp\{(\text{TCor}) \times t + (\text{PCor}) \times p\} \times \text{Oxsat}(t, s)$$

where p is pressure in dbar, t is temperature in $^{\circ}\text{C}$ and s is salinity in psu. Oxsat is oxygen saturation value minus the volume of oxygen gas (STP) absorbed from humidity-saturated air. Soc, offset, TCor and PCor are the calibration coefficients. The best fit sets of coefficients are determined by minimizing the sum of absolute deviation with a weight from the bottle oxygen data.

The down-cast CTD data sampled at same density of the up-cast CTD data created by the software module ROSSUM are used after the post-cruise calibration for the CTD temperature and salinity.

The coefficients were determined for some groups of the CTD stations. The calibration coefficients and number of the data used for the calibration are listed in Table 3.1.12. The results of the post-cruise calibration for the CTD oxygen are summarized in Table 3.1.13 and shown in from Figures 3.1.12 and 3.1.13.

Table 3.1.12 Calibration coefficients for the CTD oxygen. Number of data used is also listed.

Station	Number	Soc	Offset	TCor	PCor
P01_28_2-P01_36_1	299	0.4617342	-0.5212380	2.2118097e-3	1.3725459e-4
P01_37_1-P01_44_2	313	0.4654003	-0.5219757	2.0347435e-3	1.3653978e-4
P01_45_1-P01_52_1	239	0.4712498	-0.5226352	1.3921095e-3	1.3539851e-4
P01_53_1-P01_56_1	142	0.4746477	-0.5203241	8.6392465e-4	1.3356417e-4
P01_57_1-P01_59_1	107	0.4747909	-0.5253515	1.2616959e-3	1.3577596e-4
P01_60_2-P14N_29_1	105	0.4771914	-0.5168202	1.0539244e-4	1.3202413e-4
P14N_28_1-P14N_21_1	267	0.4763509	-0.5223087	6.2960998e-4	1.3445401e-4
P14N_20_1-P14N_4_1	459	0.4688899	-0.5227800	2.8376767e-3	1.3873165e-4
P14N_30_1-P14N_35_1	212	0.4731548	-0.5194302	1.4379132e-3	1.3444478e-4
P14N_36_1-P14N_38_1	35	0.4893230	-0.5237080	-9.4980732e-4	1.3213583e-4
P14N_39_1-P14N_54_1	543	0.4774736	-0.5235095	1.8334515e-3	1.3497810e-4
P14N_55_1-P14N_73_1	604	0.4696442	-0.5195310	2.2965664e-3	1.3703207e-4
P14N_74_2-P14N_109_1	1174	0.4747268	-0.5257560	1.7272031e-3	1.3737072e-4
P14N_109_2-P14N_125_1	584	0.4759044	-0.5260304	1.8433363e-3	1.3730910e-4
P14N_126_1-P14N_155_1	1028	0.4821183	-0.5331461	1.7173733e-3	1.3781520e-4
P14N_156_1-P14N_171_1	525	0.4786612	-0.5326933	2.1517595e-3	1.3916129e-4
P14N_172_1-P14N_185_1	328	0.4577516	-0.5081243	3.2346432e-3	1.4062034e-4
P14C_48_1-P14C_36_1	376	0.4586324	-0.5078367	3.1528881e-3	1.3845760e-4
P14C_35_1-P14C_19_1	501	0.4590327	-0.5006313	2.9939197e-3	1.3471839e-4
P14C_18_1-P14C_1_1	395	0.4587594	-0.5018013	3.1010637e-3	1.3465825e-4

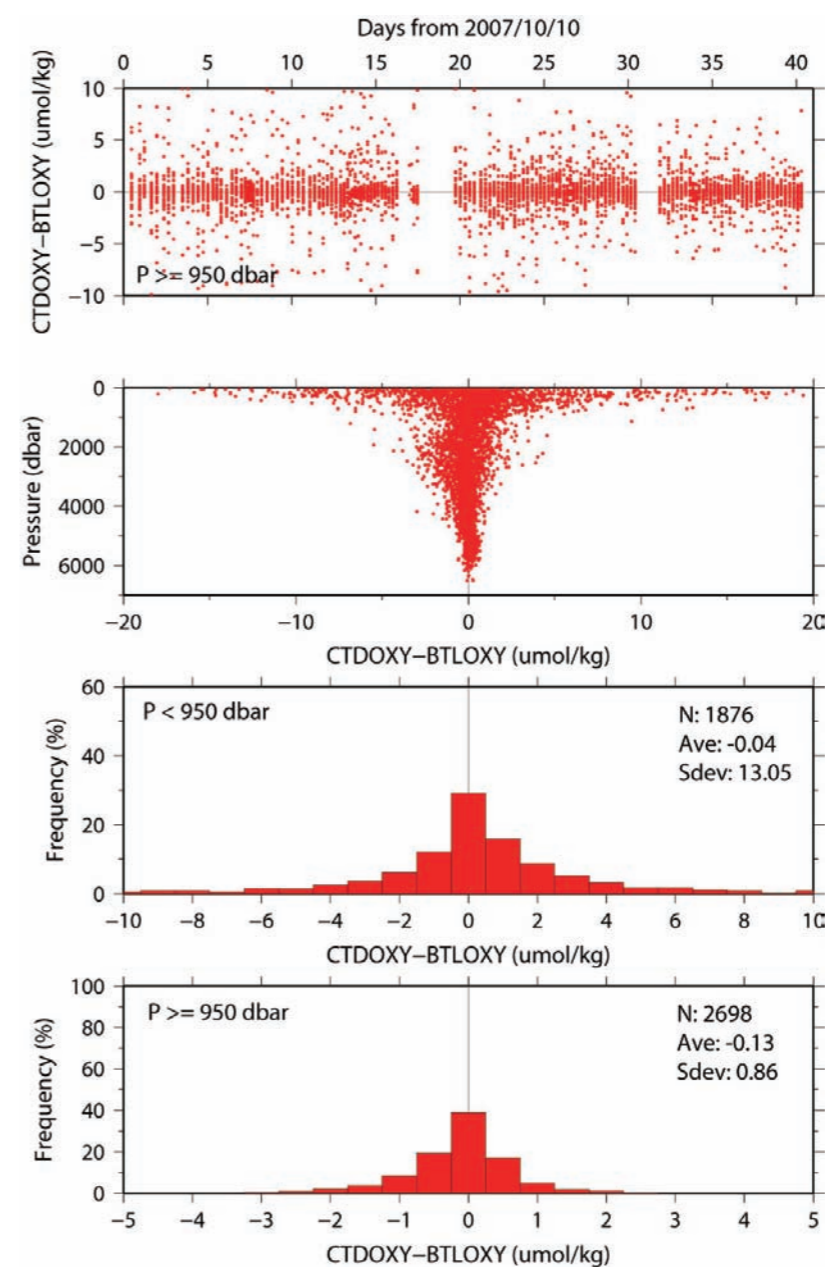

Figure 3.1.12 Difference between the CTD oxygen and the bottle oxygen for after the post-cruise calibration for leg 1. Lower two panels show histogram of the difference.

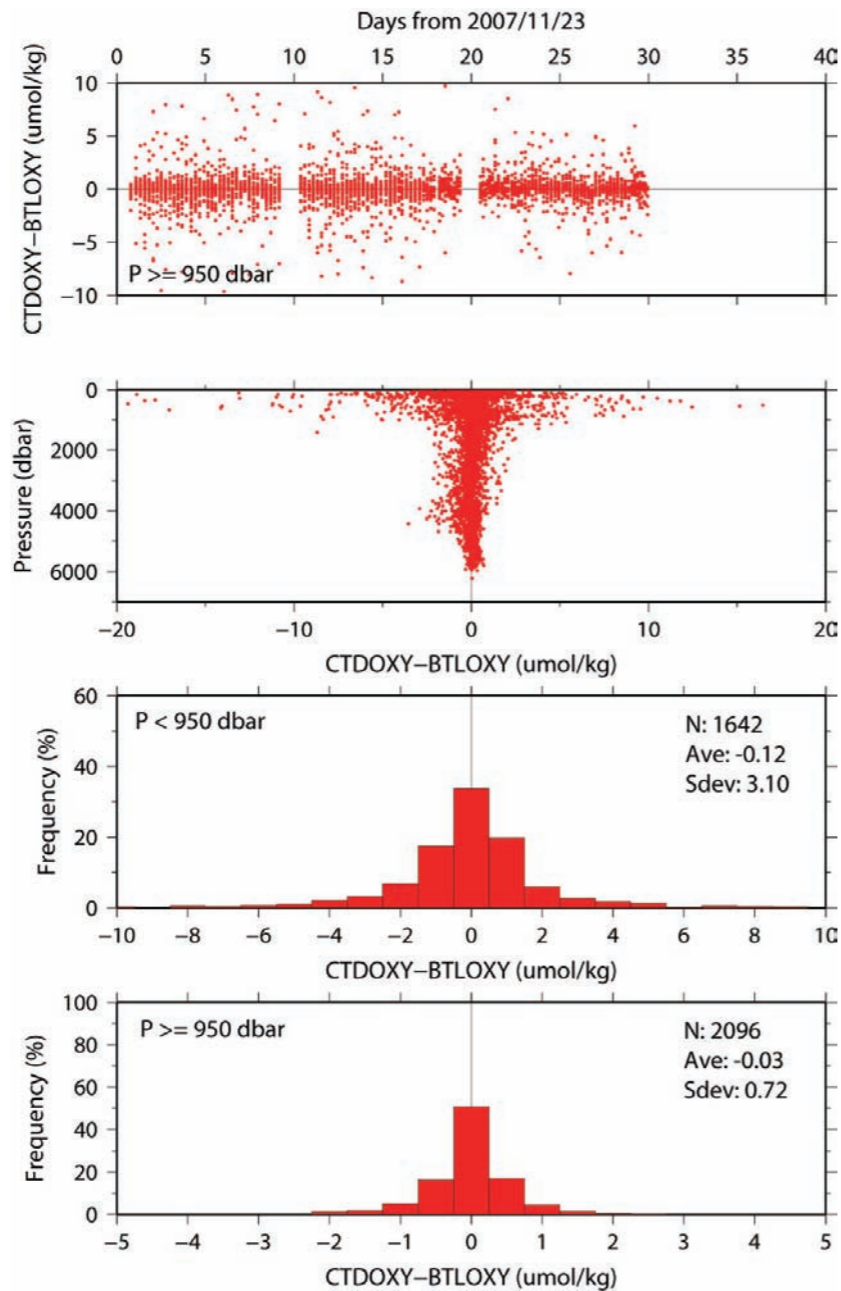

Figure 3.1.13 Difference between the optode oxygen and the bottle oxygen for after the post-cruise calibration for leg 2. Lower two panels show histogram of the difference.

Table 3.1.13 Difference between the CTD oxygen and the bottle oxygen after the post-cruise calibration.

Mean and standard deviation (Sdev) are calculated for the data below and above 950 dbar. Number of data used is also shown.

Pressure \geq 950 dbar			Pressure < 950 dbar		
Number	Mean ($\mu\text{mol/kg}$)	Sdev ($\mu\text{mol/kg}$)	Number	Mean ($\mu\text{mol/kg}$)	Sdev ($\mu\text{mol/kg}$)
<i>Leg 1</i>					
2698	-0.13	0.86	1876	-0.04	13.05
<i>Leg 2</i>					
2096	-0.03	0.72	1642	-0.12	3.10

References

- Fukasawa, M., T. Kawano and H. Uchida (2004): Blue Earth Global Expedition collects CTD data aboard Mirai, BEAGLE 2003 conducted using a Dynacon CTD traction winch and motion-compensated crane, *Sea Technology*, 45, 14–18.
- Kawano, T. and H. Uchida (Eds.) (2007): *WHP P03 Revisit Data Book*, 208 pp., JAMSTEC, Yokosuka, Kanagawa, Japan.
- Uchida, H., K. Ohya, S. Ozawa, and M. Fukasawa (2007): In situ calibration of the Sea-Bird 9plus CTD thermometer, *J. Atmos. Oceanic Technol.*, 24, 1961–1967.
- Uchida, H., T. Kawano, I. Kaneko, and M. Fukasawa (2008): In situ calibration of optode-based oxygen sensors, *J. Atmos. Oceanic Technol.*, 25, 2271–2281.

3.2 Salinity

31 October 2008

(1) Personnel

Takeshi Kawano (JAMSTEC)

Fujio Kobayashi (MWJ)

Naoko Takahashi (MWJ)

Tatsuya Tanaka (MWJ)

(2) Objectives

Bottle salinities were measured to compare with CTD salinities for calibrating CTD salinities and for identifying leaking bottles

(3) Instrument and Method

(3.1) Salinity Sample Collection

Samples for salinity measurement were collected and stored in 250-ml brown borosilicate glass bottles with GL32 screw caps with PTFE liners. Each bottle was rinsed three times with sample water, and then the water was allowed to overflow the bottle for few seconds. Excess water was poured out until the water was level with the shoulder of the bottle. The caps were also thoroughly rinsed and then tightly screwed onto the bottles. The sealed bottles were rinsed with fresh water (cap side up) and dried on a towel. The bottles were stored upside down in a carrying case and brought to the laboratory for temperature equilibration. Samples were stored more than 12 hours in the laboratory where the salinity was to be measured.

(3.2) Instruments and Method

The measurements were conducted with two Guildline Autosal laboratory salinometers

(Model 8400B S/N 62556 and S/N 62827), which were modified by the addition of a peristaltic-type sample intake pumps (provided by OSIL). Two digital platinum resistance thermometers (Model 9540) were used to measure temperature: one placed in the bath of the Autosal to measure the bath temperature, and the other placed beside the Autosal to measure the ambient temperature. The measurement system was almost same as Aoyama et al (2003). The Autosal and thermometers were connected to a laptop computer through Binary Coded Decimal output and GP-IB interfaces, respectively. When the function dial was turned to the 'read' setting, 31 readings of the double conductivity ratio were acquired after a pause of 5 seconds. Acquisition of the 31 readings took about 10 seconds. The double conductivity ratio of a sample was taken to be the median of the 31 readings. The temperature was taken to be the average of the values measured before and after readings of the double conductivity ratio.

The salinometer was operated in the air-conditioned ship's laboratory at a bath temperature of 24 °C. An ambient temperature varied from approximately 20 °C to 24 °C, while a bath temperature is very stable and varied within +/- 0.002 °C on rare occasion. The double conductivity ratio (along with temperature) was sampled for the sixth and seventh fillings of the conductivity cell. If the difference between the double conductivity ratios obtained for these two fillings was smaller than 0.00002, the average of the two double conductivity ratios was used to calculate the salinity. If the difference was greater than or equal to 0.00003, we measured an additional filling of the cell. If the double conductivity ratio obtained for the additional filling did not satisfy the criterion specified above, we measured two additional fillings of the cell, and the median of the double conductivity ratios for the five fillings was used to calculate the salinity. Algorithm for practical salinity scale, 1978 (UNESCO, 1981) was employed to convert the conductivity ratios to salinities

The measurements were typically conducted for 16 hours a day and the cell was rinsed by pure water every day and cleaned by ethanol or soap or both after the daily measurement.

(3.3) Preliminary Result

(i) MR07-04

Standard Seawater

Standardization control was set to 452 and all the measurements were done by this setting. STNBY was 5398 +/- 0001 and ZERO was 0.00001 +/- 0.00001. We used IAPSO Standard Seawater batch P148 whose conductivity ratio was 0.99982 (double conductivity ratio is 1.99964) as the standard for salinity. We measured 37 bottles of P148 during routine measurement from Stn.1 to Stn.28 and 78 bottles from Stn.40 to Stn.115.

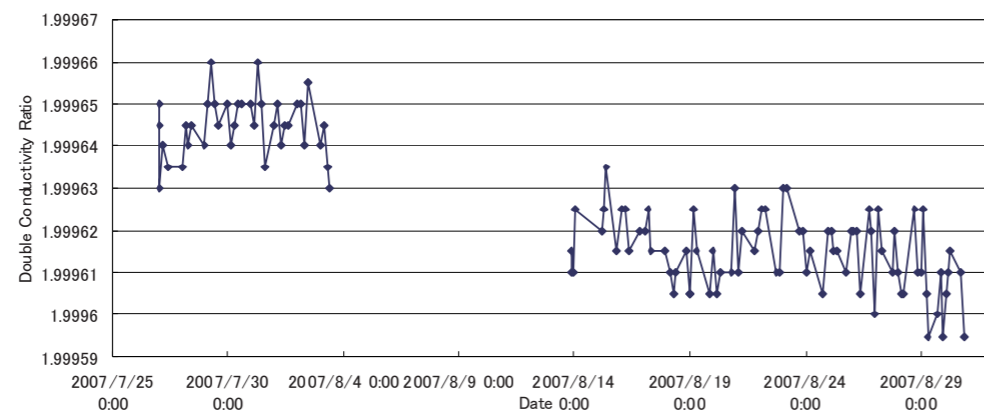

Fig.3.2.1 History of Double conductivity ratio of P148 during Leg.1. X

and Y axes represents date and double conductivity ratio, respectively.

Fig.3.2.1 shows the history of double conductivity ratio of the Standard Seawater batch P148. During the period from 27, July to 4, August, the average of double conductivity ratio was 1.99985 and no drifts was calculated. Therefore we subtract 0.00001 from double conductivity ratio of samples measured during this period. Because of the trouble described in Section.1, measurement was interrupted for about 10 days. During the period from 13 August, double conductivity ratio of SSW was

around 1.99862, however, after 28 August, it became smaller, probably due to cooling of room temperature. Therefore, we added 0.00002 to double conductivity ratio of samples measured from 13 August to 28 August, and 0.00003 to it measured after 28 August. Correction for the history of double conductivity ratio after this correction was shown in Fig.3.2.2. After correction, the average of double conductivity ratio of 115 bottles of SSW became 1.999636 and the standard deviation was 0.00008, which is equivalent to 0.0002 in salinity.

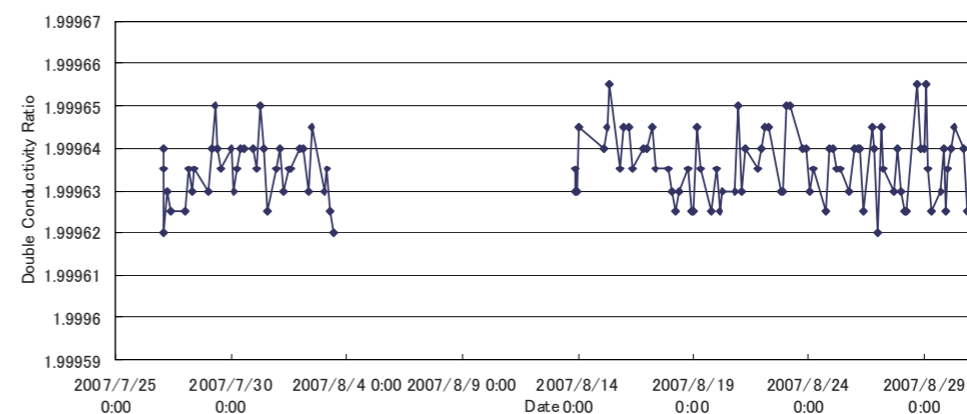

Fig.3.2.2 History of Double conductivity ratio of P148. X and Y axes represent time

Date and double conductivity ratio, respectively. (after correction)

Sub-Standard Seawater

We also measured sub-standard seawater periodically to monitor the conditions of the Autosal. Approximately 20 L of seawater collected from a deep layer and gravity filtered through a membrane filter (Millipore HA, pore size 0.45 μm) was used as sub-standard seawater. The sub-standard seawater was stored in an aged cubitainer with no headspace and stirred for at least 24 hours before use. Sub-standard seawater was measured every six samples in case of a sudden drift in the Autosal. During the whole measurements, there was no detectable sudden drift of the salinometer.

Replicates

We took 491 pairs of replicates. Fig.3.2.3 shows the histogram of the absolute difference between replicate samples. There were 4 bad measurements and 5 questionable measurements of replicate samples. Excluding these bad and questionable measurements, the average and standard deviation of the absolute difference of 482 pairs of replicate samples was 0.0018 and 0.00019 in salinity, respectively.

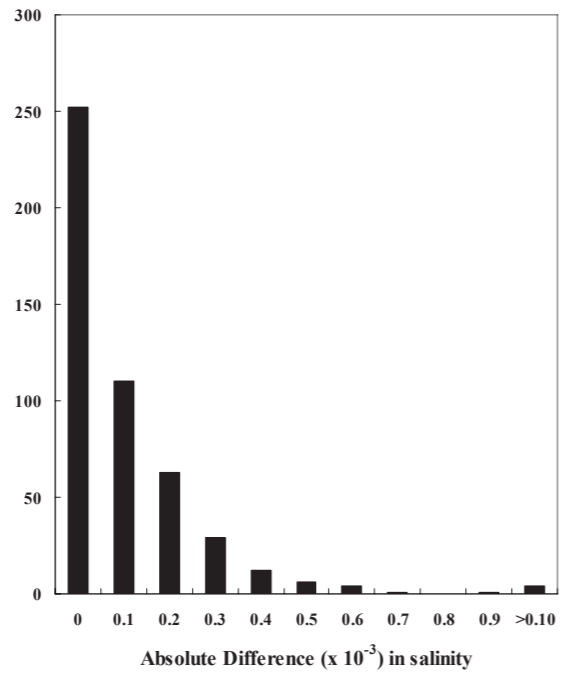

Fig.3.2.3 The histogram of the absolute difference between replicate samples.

(ii) MR07-06 Leg.1

Standard Seawater

Leg.1

Standardization control was set to 460 and all measurements were done by this setting. STNBY was 5402 +/- 0001 and ZERO was 0.00001 +/- 0.00001. We used IAPSO Standard Seawater batch P148 whose conductivity ratio was 0.99982 (double conductivity ratio is 1.99964) as the standard for salinity. We measured 146 bottles of P148 during routine measurement.

Fig.3.2.4 shows the history of double conductivity ratio of the Standard Seawater batch P148.

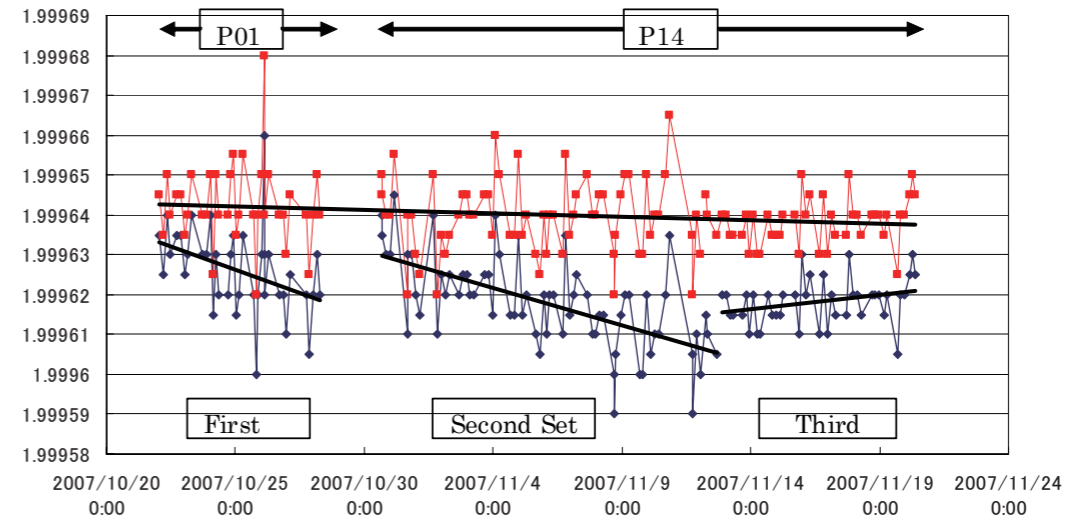

Figure 3.2.4. The history of double conductivity ratio of the Standard Seawater batch P142.

Drifts were calculated by fitting data from P148 to the equation obtained by the least square method (solid lines). Correction for the double conductivity ratio of the sample was made to compensate for the drift. After the drift correction, we add 0.00001 for the first and second set and 0.00002 for the third set to make the average to 1.99964. After these corrections, the standard deviation of 146 bottles becomes 0.000009, which is equivalent to 0.0002 in salinity.

Sub-Standard Seawater

We also measured sub-standard seawater periodically to monitor the conditions of the Autosol. Approximately 20 L of seawater collected from a deep layer and gravity filtered through a membrane filter (Millipore HA, pore size 0.45 μm) was used as sub-standard seawater. The sub-standard seawater was stored in an aged cubitainer with no headspace and stirred for at least 24 hours before use. Sub-standard seawater was measured every six samples in case of a sudden drift in the Autosol. During the whole measurements, there was no detectable sudden drift of the salinometer.

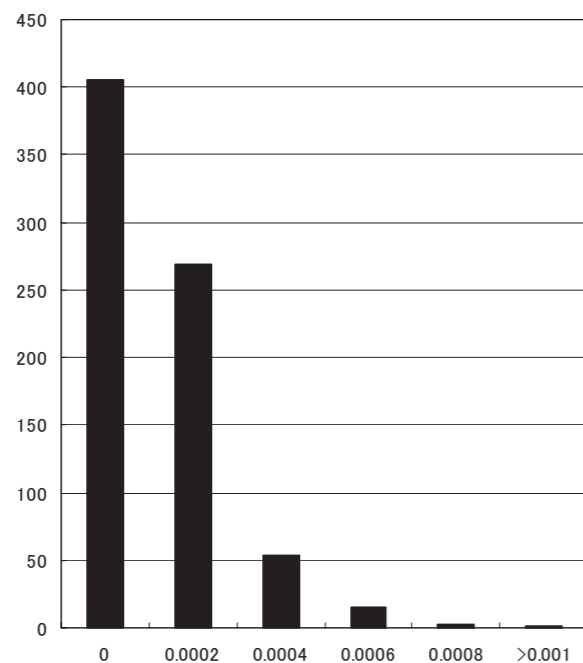

Figure 3.2.5 . The histogram of the absolute difference between each pair of replicate samples in Leg.1. X axis is absolute difference in salinity and Y axis is frequency..

Replicates

We took 840 pairs of replicate. Fig.3.2.5 shows the histogram of the absolute difference between each pair of the replicate samples. There were 6 bad measurements in the replicate samples. Excluding these bad measurements, the standard deviation of the absolute difference in 834 pairs of the replicate samples was 0.00017 in salinity.

(iii)MR07-06 Leg.2

Standard Seawater

Standardization control was set to 464 and all measurements were done by this setting. STNBY was 5402 +/- 0001 and ZERO was 0.00001 +/- 0.00001. We used IAPSO Standard Seawater batch P148 as the standard for salinity. We measured 160 bottles of P148 during routine measurement. There were 2 bad bottles whose conductivities were extremely high. Data of these 2 bottles are not taken into consideration hereafter.

Fig.3.2.6 shows the history of double conductivity ratio of the Standard Seawater batch P148. Drifts were calculated by fitting data from P148 to the equation obtained by the least square method (solid lines). Correction for the double conductivity ratio of the sample was made to compensate for the drift. After correction, the average of double conductivity ratio became 1.999625 and the standard deviation was 0.00008, which is equivalent to 0.0002 in salinity. We added 0.000015 to make an average to 1.99964.

Sub-Standard Seawater

We also measured sub-standard seawater periodically to monitor the conditions of the Autosol. Approximately 20 L of seawater collected from a deep layer and gravity filtered through a membrane filter (Millipore HA, pore size 0.45 μm) was used as sub-standard seawater. The sub-standard seawater was stored in an aged cubitainer with no headspace and stirred for at least 24 hours before use. Sub-standard seawater was measured every six samples in case of a sudden drift in the Autosol.

During the whole measurements, there was no detectable sudden drift of the salinometer.

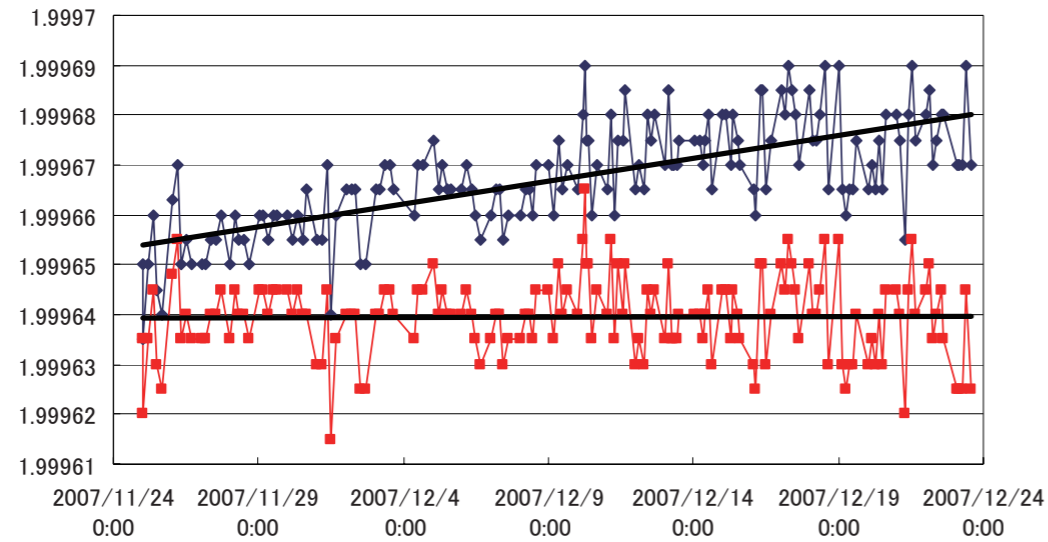

Fig.3.2.6 History of Double conductivity ratio of P148 during Leg.2. X and Y axes represents date and double conductivity ratio, respectively..

Replicates

We took 749 pairs of replicate samples. Fig.3.2.7 shows the histogram of the absolute difference between each pair of the replicate samples. There were 4 questionable measurements in the replicate samples. Excluding these questionable measurements, the standard deviation of the absolute difference in 745 pairs of the replicate samples was 0.00016 in salinity.

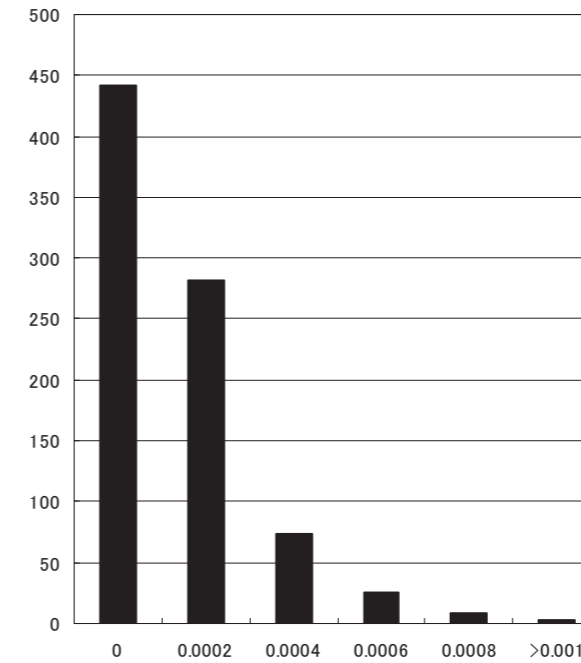

Figure 3.2.7 The histogram of the absolute difference between each pair of replicate samples in Leg.2. X axis is absolute difference in salinity and Y axis is frequency.

References

- Aoyama, M., T. Joyce, T. Kawano and Y. Takatsuki: Standard seawater comparison up to P129. Deep-Sea Research, I, Vol. 49, 1103~1114, 2002
- UNESCO: Tenth report of the Joint Panel on Oceanographic Tables and Standards. UNESCO Tech. Papers in Mar. Sci., 36, 25 pp., 1981

3.3 Oxygen

9 November 2008

(1) Personnel

Yuichiro Kumamoto (JAMSTEC)

Kimiko Nishijima (MWJ)

Keisuke Wataki (MWJ)

Masanori Enoki (MWJ)

Miyo Ikeda (MWJ)

Yukiko Hayakawa (MWJ)

(2) Objectives

Dissolved oxygen is one of good tracers for the ocean circulation. Recent studies in the North Pacific indicated that dissolved oxygen concentration in intermediate layers decreased in basin-wide scale during the past decades. The causes of the decrease, however, are still unclear. During cruises of MR07-04 conducted from 24-Jul-07 to 03-Sep-07 and MR07-06 from 08-Oct-07 to 25-Dec-07, we measured dissolved oxygen concentration from surface to bottom layers at all the hydrocast stations along around 47°N in the subarctic North Pacific and along 179°E in the central Pacific. These stations reoccupied the WHP-P01 (1985), WHP-P14N (1993), and WHP-P14C (1992) stations. Our purpose is to evaluate temporal changes in dissolved oxygen in the Pacific Ocean between the 1980/90s and 2007.

(3) Reagents

Pickling Reagent I: Manganous chloride solution (3M)

Pickling Reagent II: Sodium hydroxide (8M) / sodium iodide solution (4M)

Sulfuric acid solution (5M)

Sodium thiosulfate (0.025M)

Potassium iodate (0.001667M)

CSK standard of potassium iodate: Lot EWL3818, Wako Pure Chemical Industries Ltd., 0.0100N

(4) Instruments

Burette for sodium thiosulfate and potassium iodate: APB-510 manufactured by Kyoto Electronic Co.

Ltd. / 10 cm³ of titration vessel

Detector: Automatic photometric titrator, DOT-01 manufactured by Kimoto Electronic Co. Ltd.

(5) Seawater sampling

Following procedure is based on a determination method in the WHP Operations Manual (Dickson, 1996). Seawater samples were collected from 12-liters Niskin sampler bottles attached to the CTD-system. Seawater for bottle oxygen measurement was transferred from the Niskin sampler bottle to a volume calibrated glass flask (ca. 100 cm³). Three times volume of the flask of seawater was overflowed. Sample temperature was measured by a thermometer during the overflowing. Then two reagent solutions (Reagent I, II) of 0.5 cm³ each were added immediately into the sample flask and the stopper was inserted carefully into the flask. The sample flask was then shaken vigorously to mix the contents and to disperse the precipitate finely throughout. After the precipitate has settled at least halfway down the flask, the flask was shaken again to disperse the precipitate. The sample flasks containing pickled samples were stored in a laboratory until they were titrated.

(6) Sample measurement

At least two hours after the re-shaking, the pickled samples were measured on board. A magnetic stirrer bar and 1 cm³ sulfuric acid solution were added into the sample flask and stirring began. Samples were titrated by sodium thiosulfate solution whose molarity was determined by potassium iodate solution. Temperature of sodium thiosulfate during titration was recorded by a thermometer. We measured dissolved oxygen concentration using two sets of the titration apparatus, named DOT-1

and DOT-3. Dissolved oxygen concentration ($\mu\text{mol kg}^{-1}$) was calculated by the sample temperature during the sampling, CTD salinity, flask volume, and titrated volume of the sodium thiosulfate solution.

(7) Standardization

Concentration of sodium thiosulfate titrant (ca. 0.025M) was determined by potassium iodate solution. Pure potassium iodate was dried in an oven at 130°C. 1.7835 g potassium iodate weighed out accurately was dissolved in deionized water and diluted to final volume of 5 dm³ in a calibrated volumetric flask (0.001667M). 10 cm³ of the standard potassium iodate solution was added to a flask using a volume-calibrated dispenser. Then 90 cm³ of deionized water, 1 cm³ of sulfuric acid solution, and 0.5 cm³ of pickling reagent solution II and I were added into the flask in order. Amount of titrated volume of sodium thiosulfate (usually 5 times measurements average) gave the molarity of the sodium thiosulfate titrant. Table 3.3.1 and 3.3.2 show result of the standardization during the two cruises. Error (C.V.) of the standardization was $0.02 \pm 0.01 \%$, c.a. $0.05 \mu\text{mol kg}^{-1}$.

(8) Determination of the blank

The oxygen in the pickling reagents I (0.5 cm³) and II (0.5 cm³) was assumed to be 3.8×10^{-8} mol (Murray *et al.*, 1968). The blank from the presence of redox species apart from oxygen in the reagents (the pickling reagents I, II, and the sulfuric acid solution) was determined as follows. 1 and 2 cm³ of the standard potassium iodate solution were added to two flasks respectively. Then 100 cm³ of deionized water, 1 cm³ of sulfuric acid solution, and 0.5 cm³ of pickling reagent solution II and I each were added into the two flasks in order. The blank was determined by difference between the two times of the first (1 cm³ of KIO₃) titrated volume of the sodium thiosulfate and the second (2 cm³ of KIO₃) one. The results of three-time blank determinations were averaged and listed in Table 3.3.1 (MR07-04) and Table 3.3.2 (MR07-06). During MR07-04 cruise, the averaged blank of DOT-3 was -0.010 ± 0.001 (S.D., n=17) cm³. That of DOT-1 decreased from -0.003 ± 0.001 (S.D., n=4) to -0.009 ± 0.002 (S.D., n=12) cm³ on July 31 because the pickling reagents for DOT-1 were replaced. During

MR07-06 cruise, The averaged blank values for DOT-1 and DOT-3 before December 20 were -0.007 ± 0.001 (S.D., n=30) and -0.007 ± 0.001 (S.D., n=29) cm³, respectively. After the day, the values of the blank increased by about 0.005 cm³ in the sample measurements for P14C-001~009 because we replaced the pickling reagents II solution. We also confirmed that there was no systematic bias in the blank determination between the DOT-1 and DOT-3 measurements on the both cruises.

Table 3.3.1 Results of the standardization and the blank determinations during MR07-04.

Date (UTC)	KIO ₃		DOT-1 (cm ³)			DOT-3 (cm ³)			Samples (Stations)
	#	ID No.	Na ₂ S ₂ O ₃	E.P.	blank	Na ₂ S ₂ O ₃	E.P.	blank	
2007/07/26		20070619-05-02	20070613-01-03	3.960	-0.002	20070613-01-04	3.952	-0.011	P01-001,002,003,004,005,006,007
2007/07/27		20070619-05-03	20070613-02-03	3.959	-0.003	20070613-02-04	3.950	-0.012	P01-008,009,010,011,012
2007/07/28		20070619-05-04	20070413-03-01	3.968	-0.003	20070413-03-02	3.962	-0.011	P01-013,014,015,016,017,018
2007/07/30	1	20070619-05-05	20070413-03-01	3.968	-0.003	20070413-03-02	3.960	-0.010	P01-019,020,021,022,023,024 (DOT-01)
2007/07/30		20070619-05-06	—	—	—	20070413-03-02	3.961	-0.011	P01-019,020,021,022,023,024 (DOT-03)
2007/07/31		20070619-05-07	20070613-03-03	3.961	-0.011	20070613-03-04	3.959	-0.011	P01-025,026,027,028

2007/08/12	2	20070619-06-01	20070413-03-03	3.960	-0.009	20070413-03-04	3.962	-0.011	P01-040,044	
2007/08/14		20070619-06-02	20070413-04-01	3.960	-0.010	20070413-04-02	3.960	-0.011	P01-058,060,061,062,063	
2007/08/15		20070619-06-03	20070413-04-01	3.962	-0.009	20070413-04-02	3.961	-0.010	P01-064,065,066,067,068	
2007/08/17		20070619-06-04	20070413-04-03	3.960	-0.012	20070413-04-04	3.962	-0.011	P01-069,070,071,072,073,074	
2007/08/19		20070619-06-05	20070413-04-03	3.962	-0.006	20070413-04-04	3.962	-0.010	P01-X15,076,077,078,079,080	
2007/08/21		20070619-06-06	20070413-05-01	3.961	-0.009	20070413-05-02	3.959	-0.010	P01-081,082,083,084,085,086	
2007/08/23		20070619-06-07	20070413-05-01	3.961	-0.008	20070413-05-02	3.959	-0.009	P01-X16,087,088,089	
2007/08/24		20070619-06-08	20070413-05-03	3.959	-0.009	20070413-05-04	3.961	-0.010	P01-090,092,X17,094,095	
2007/08/25		20070619-07-01	20070413-05-03	3.959	-0.008	20070413-05-04	3.960	-0.011	P01-096,097,098,099,100,101	
2007/08/27		3	20070619-07-02	20070413-06-01	3.957	-0.010	20070413-06-02	3.958	-0.011	P01-102,103,104,105,106,107
2007/08/28		20070619-07-03	20070413-06-01	3.958	-0.012	20070413-06-02	3.960	-0.008	P01-108,109,110,111,112,113,114,115	

Batch number of the KIO₃ standard solution

Table 3.3.2 Results of the standardization and the blank determinations during MR07-06.

Date (UTC)	#	KIO ₃	DOT-1 (cm ³)			DOT-3 (cm ³)			Samples (Stations)	
		ID No.	Na ₂ S ₂ O ₃	E.P.	blank	Na ₂ S ₂ O ₃	E.P.	blank		
2007/10/09	4	20070619-09-02	20070613-03	3.951	-0.008	20070613-03	3.952	-0.007	P01-028,029,030,032	
2007/10/12		20070619-09-03	20070613-03	3.951	-0.007	20070613-03	3.952	-0.007	P01-031,033,034,035,036,037	
2007/10/14		20070619-09-04	20070613-05-01	3.953	-0.006	20070613-05-02	3.952	-0.005	P01-038,039,040,041,042,X13,043	
2007/10/16		20070619-09-05	20070613-05-01	3.953	-0.006	20070613-05-02	3.954	-0.007	P01-044,045,046,047	
2007/10/17		20070619-09-06	20070613-05-03	3.953	-0.006	20070613-05-04	3.951	-0.008	P01-048,049,050,051,052,053,054	
2007/10/18		20070619-09-07	20070613-05-03	3.952	-0.007	20070613-05-04	3.952	-0.008	P01-055,056,057,058,059,060	
2007/10/20		20070619-09-08	20070613-06-01	3.956	-0.009	20070613-06-02	3.956	-0.009	P01-061,P14N-029,028,027,026,025,024	
2007/10/22		20070619-10-01	20070613-06-01	3.957	-0.005	20070613-06-02	3.957	-0.007	P14N-023,022,021,020,019	
2007/10/23		5	20070619-10-02	20070613-06-03	3.957	-0.006	20070613-06-04	3.956	-0.006	P14N-018,017,016,015,014,013,012,011,010,009,008,007,006,005,004,003,002,001

2007/10/29		20070619-10-04	20070613-07-01	3.957	-0.007	20070613-07-02	3.957	-0.008	P14N-030,X01,032,033,034,035,036,037,038,039,040
2007/11/01	5	20070619-10-06	20070613-07-03	3.957	-0.007	20070613-07-04	3.957	-0.007	P14N-041,042,043,044,045,046,047,048,049,051,052
2007/11/04		20070619-10-08	20070613-08-01	3.955	-0.007	20070613-08-02	3.956	-0.008	P14N-053,054,055,056,057,058,059,060,061
2007/11/06		20070911-11-01	20070613-08-01	3.959	-0.006	20070613-08-02	3.960	-0.006	P14N-062,063,064,X02
2007/11/07		20070911-11-02	20070613-08-03	3.957	-0.004	20070613-08-04	3.957	-0.008	P14N-066,067,068,069,070,071,072,073
2007/11/11		20070911-11-03	20070613-08-03	3.959	-0.004	20070613-08-04	3.959	-0.008	P14N-074,075,076,077
2007/11/12	6	20070911-11-04	20070613-09-01	3.955	-0.009	20070613-09-02	3.958	-0.007	P14N-078,079,080,081,082,083,084,085,086,087,089,090
2007/11/14		20070911-11-06	20070613-09-03	3.955	-0.008	20070613-09-04	3.957	-0.008	P14N-091,092,093,094,095,096,097,098,099,100,101,102
2007/11/18		20070911-11-08	20070613-10-01	3.956	-0.010	20070613-10-02	3.958	-0.008	P14N-103,104,105,X04,107,108,109

2007/11/23		20070911-12-02	20070613-10-03	3.960	-0.007	20070613-10-04	3.959	-0.010	P14N-109(2),110,111,112,113,114,115,116,117
2007/11/26	7	20070911-12-04	20070613-11-01	3.956	-0.007	20070613-11-02	3.955	-0.009	P14N-118,119,120,121,122,123,124,125,126,127,128,129
2007/11/28		20070911-12-06	20070613-11-03	3.956	-0.007	20070613-11-04	3.957	-0.006	P14N-130,131,132,133,134,135,136,137,138,139,140,141
2007/12/01		20070911-12-08	20070613-12-03	3.953	-0.006	20070613-12-01	3.956	-0.005	P14N-142,143,144
2007/12/03		20070911-13-02	20070613-12-03	3.954	-0.007	20070613-12-01	3.956	-0.006	P14N-145,146,147,148,149,150
2007/12/04	8	20070911-13-03	20070613-12-02	3.953	-0.006	20070613-12-04	3.956	-0.005	P14N-151,152,153,154,155,156,157,158,159,160,161,162,163
2007/12/08		20070911-13-06	20070613-13-01	3.949	-0.006	20070613-13-02	3.952	-0.007	P14N-164,165,166,167,168,169,170,171,172,173,174,175,176
2007/12/11		20070911-13-08	20070613-13-03	3.951	-0.004	20070613-13-04	3.952	-0.008	P14N-177,178,179,180,181,182,183,184,185
2007/12/12	9	20070911-14-01	20070613-13-03	3.944	-0.006	-	-	-	P14N-184,185

2007/12/13	9	20070911-14-02	20070613-13-03	3.950	-0.007	20070613-13-04	3.950	-0.008	P14C-049,048,052,051,050,047,046,045,044
2007/12/14		20070911-14-03	20070613-14-01	3.956	-0.006	20070613-14-02	3.958	-0.007	P14C-043,042,041,040,039,038,037,036
2007/12/17		20070911-14-05	20070613-14-03	3.955	-0.008	20070613-14-04	3.956	-0.009	P14C-032,031,030,029,028,027,026,025,024,023,022,021,020,019
2007/12/22	10	20070911-15-01	20070613-15-01	3.966	0.002	20070613-15-02	3.967	0.004	P14C-009,008,007
2007/12/22		20070911-15-02	20070613-15-03	3.967	0.001	20070613-15-04	3.965	-0.001	P14C-006,005,004,003,002,001

Batch number of the KIO₃ standard solution

(9) Replicate sample measurement

Replicate samples were taken from every CTD cast. The replicate sample pairs of good measurement (flagged 2) during MR07-04 and MR07-06 cruises were 236 and 739, respectively. The total number of the replicate pairs, 975 was about 9 % of the total sample measurements. The standard deviations of the replicate measurements during MR07-04 and MR07-06 cruises were 0.10 and 0.08 $\mu\text{mol kg}^{-1}$, respectively, which was calculated by a procedure (SOP23) in DOE (1994). In addition, there was no significant difference between the DOT-1 and

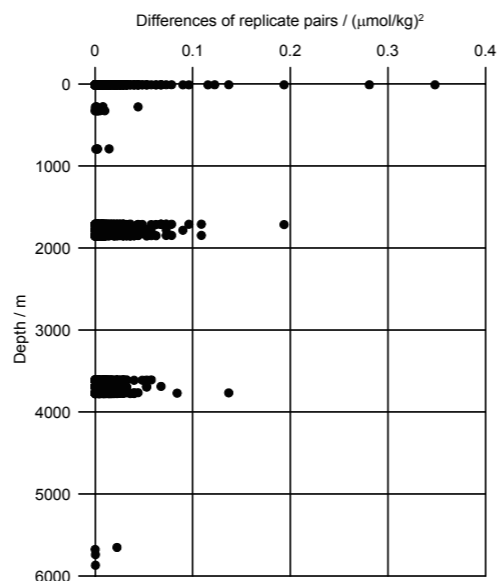

Figure 3.3.1 Differences of replicate sample pairs against sampling depth.

DOT-3 measurements on the both cruises. Although there are several outlying data, relationship between the difference in the replicate sample pairs and sampling depth was not clear (Fig. 3.3.1). The difference also did not depend on measurement date (Fig. 3.3.2). In the hydrographic data sheet, the results of the replicate sample pairs were averaged and flagged “2” (see section 11).

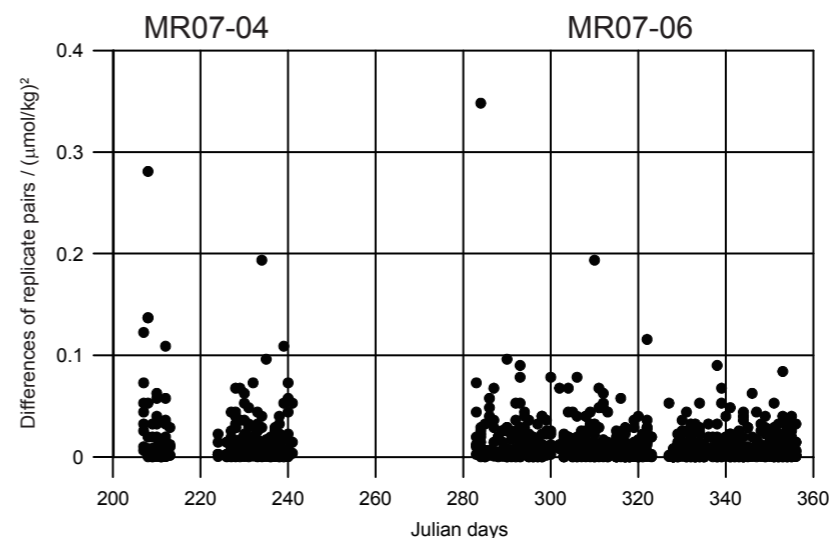

Figure 3.3.2 Differences of replicate sample pairs against measurement date (Julian days).

(10) CSK standard measurements

The CSK standard is a commercial potassium iodate solution (0.0100 N) for analysis of dissolved oxygen. During MR07-04 and MR07-06 cruises, we measured six bottles of the CSK standard solutions (Lot EWL3818) against our KIO₃ standards as samples (Table 3.3.3). A good agreement among them confirms that there was no systematic shift in our oxygen measurements during the two cruises. These values also agree with those measured in our previous cruises, MR07-03, suggesting comparability in the oxygen measurements among the three cruises.

Table 3.3.3 Results of the CSK standard (Lot EWL3818) measurements on board.

Date (UTC)	KIO ₃ ID No.	DOT-1		DOT-3		Remarks
		Conc. (N)	error (N)	Conc. (N)	error (N)	
2007/10/07	20070619-08-05	0.010009	0.000002	–	–	MR07-06
2007/11/19	20070911-12-01	0.010003	0.000001	0.010000	0.000001	
2007/11/23	20070911-12-02	0.010000	0.000001	0.010003	0.000002	
2007/12/23	20070911-15-09	0.010006	0.000002	0.010007	0.000001	
2007/07/23	20070619-05-01	0.009999	0.000001	0.010002	0.000002	MR07-04
2007/08/29	20070619-07-04	0.010004	0.000001	0.010006	0.000003	
2007/06/10	20070424-01-08	–	–	0.010006	0.000002	MR07-03
2007/07/24	20070425-01-06	0.010006	0.000003	0.010005	0.000002	

(11) Quality control flag assignment

Quality flag values were assigned to oxygen measurements using the code defined in Table 0.2 of WHP Office Report WHPO 91-1 Rev.2 section 4.5.2 (Joyce *et al.*, 1994). Measurement flags of 2 (good), 3 (questionable), 4 (bad), and 5 (missing) have been assigned (Tables 3.3.4). The replicate data were averaged and flagged 2 if both of them were flagged 2. If either of them was flagged 3 or 4, a datum with "younger" flag was selected. Thus we did not use flag of 6 (replicate measurements). For the choice between 2, 3, or 4, we basically followed a flagging procedure as listed below:

- Bottle oxygen concentration and difference between bottle oxygen and CTD oxygen at the sampling layer were plotted against CTD pressure. Any points not lying on a generally smooth trend were noted.
- Dissolved oxygen was then plotted against sigma-theta. If a datum deviated from a group of plots, it was flagged 3.
- Vertical sections against pressure and potential density were drawn. If a datum was anomalous on the section plots, datum flag was degraded from 2 to 3, or from 3 to 4.

d. If the bottle flag was 4 (did not trip correctly), a datum was flagged 4 (bad). In case of the bottle flag 3 (leaking) or 5 (unknown problem), a datum was flagged based on the procedure shown above.

Table 3.3.4 Summary of assigned quality control flags.

Flag	Definition	MR07-04	MR07-06	Total
2	Good	2,628	8,312	10,940
3	Questionable	1	19	20
4	Bad	0	17	17
5	Not report (missing)	1	2	3
Total		2,630	8,350	10,980

(12) Preliminary Results

(12.1) Comparison with Winkler oxygen measurements by University of Washington on board

At station MR07-06_P01-035, conducted an inter-comparison of Winkler oxygen measurements between University of Washington and JAMSTEC on board. Seawater sample for UW was collected just after the oxygen sampling for JAMSTEC. The oxygen concentrations in the samples from 15 Niskin bottles

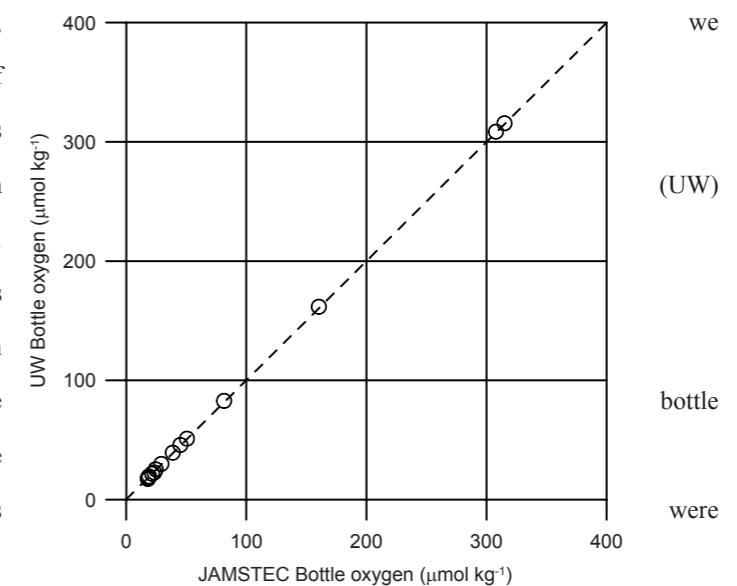

Figure 3.3.3 Comparison of bottle oxygen measurement between UW and JAMSTEC. A broken line shows a linear regression line whose correlation coefficient (r^2) and standard error are 0.99997 and $0.567 \mu\text{mol kg}^{-1}$, respectively.

analyzed separately by UW and JAMSTEC and compared each other. We got a very good agreement between UW and JAMSTEC results (Fig. 3.3.3).

(12.2) Comparison of oxygen measurements at a cross point

During MR07-06 cruise, we compared two profiles of bottle oxygen at a cross point, 47.0°N/179.5°E. The first and second casts were conducted on 20-Oct.-2007 (MR07-06_P01-061) and 30-Oct.-2007 (MR07-06_P14N-X01), respectively. Below 1200 dbar, we got a good agreement between the first and second measurements (Fig. 3.3.4). We had also measured bottle oxygen concentration at the cross point during our previous cruise, MR07-04 (P01-061, 14-Aug.-2007). The oxygen profile in deep waters at the cross point of MR07-04 well agreed with those of MR07-06 (Fig. 3.3.4).

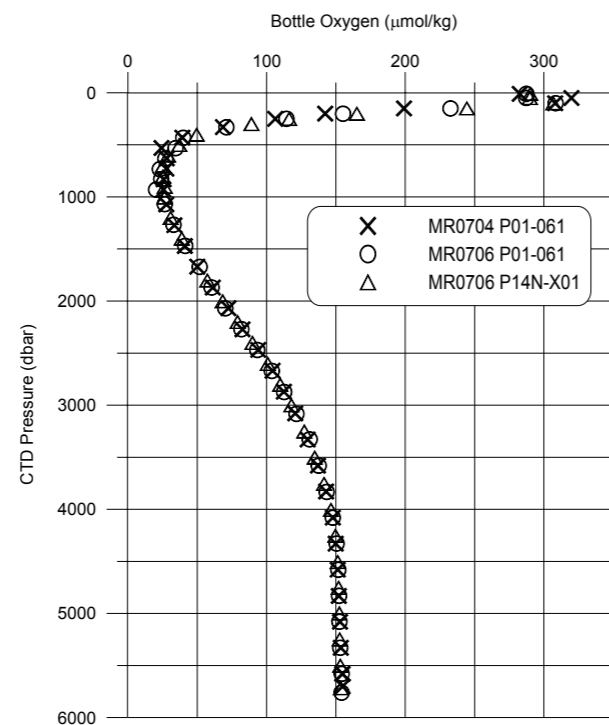

Figure 3.3.4 Vertical profiles of bottle oxygen concentration at a cross point (47.0°N/179.5°E) during MR07-06 and MR07-04 cruises.

(12.3) Decadal changes in dissolved oxygen along WHP-P01

Figure 3.3.5 shows zonal transects of dissolved oxygen along WHP-P01 in 2007. From 152°E (P01-028) to 179°E (P01-061), we re-occupied during MR07-06 in the October of 2007. The rest of the WHP-P01 stations were revisited during MR07-04 in the July and August of 2007. Difference in dissolved oxygen distribution between the eastern and western North Pacific can be distinguished. The boundary between the east and west is likely to be lying around 160°W. Dissolved oxygen concentrations in bottom waters in the west are higher than those in the east. The minimum concentration around 1000 m depth in the east was lower than that in the west.

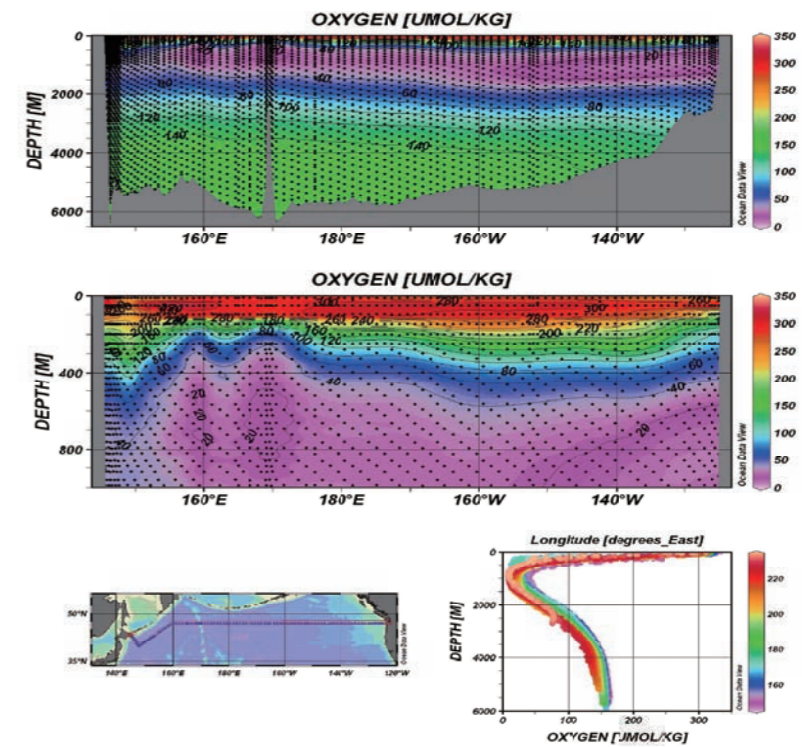

Figure 3.3.5 Zonal transects of dissolved oxygen along WHP-P01 in 2007 (Schlitzer, 2008).

We compared dissolved oxygen in deep waters below 4000 m depth in 2007 with those in 1985 and 1999 along WHP-P01. The oxygen concentration in 2007 were slightly lower than those in 1985 and 1999 by 1.9 ± 0.8 (n=641) and 1.1 ± 1.2 (n=628) $\mu\text{mol kg}^{-1}$, respectively. Despite of these small offsets in the deep layers, dissolved oxygen concentrations in the thermocline in 2007 were significantly higher than those in 1999. Distribution of differences in Apparent Oxygen Utilization (AOU) against water density between 1999 and 2007 (Fig. 3.3.6b) indicates that AOU (dissolved oxygen) decreased (increased) in waters just below seasonal mixing layer from 1999 to 2007. The maximum AOU decrease (about $-50 \mu\text{mol kg}^{-1}$) was found in $26.6 \sigma_\theta$ layer between 180° and 140°W approximately. This AOU change between 1999 and 2007 is opposite to that between 1985 and 1999 (Fig. 3.3.6a).

(12.4) Decadal changes in dissolved oxygen along WHP-P14N/C

Figure 3.3.7 shows meridional transects of dissolved oxygen along WHP-P14N/C in 2007. WHP-P14N and P14C lines are lying from the Bering Sea to the Fiji Island and from the Fiji Islands to New Zealand (the South Fuji Basin), respectively. The transect of WHP-P14N is characterized by an oxygen minimum in mid-layers from the Bering Sea to the equator. In the Central Pacific Basin from 20°N to 10°S , dissolved oxygen concentration in bottom water (Circumpolar Deep Water) is slightly high. In the South Fiji Basin, dissolved oxygen maximum was found in mid-layers around 600 – 800 m depth.

We compared dissolved oxygen in deep waters below 4000 m depth in 2007 with those in 1992/93 along WHP-P14N/C. The oxygen data in 2007 were slightly lower than those in 1992/93 by 1.3 ± 2.0 (n=1106). Figure 3.3.8 shows distribution of differences in AOU against water density between 1992/93 and 2007. Except in the Bering Sea there was not large change in dissolved oxygen or AOU.

The maximum AOU increase (about $40 \mu\text{mol kg}^{-1}$) was found in $26.6 \sigma_\theta$ layer in the Bering Sea. Small temporal changes in the tropical region between 20°N and 20°S may be caused by transition of mesoscale eddies. At a cross point between MR07-04 and MR07-06 cruises ($47^\circ\text{N}/179^\circ\text{E}$), the intermediate AOU decreased by about $30 \mu\text{mol kg}^{-1}$ from 1999 to 2007 (see Fig. 3.3.6b). On the other

(a) $\Delta\text{AOU} / \mu\text{mol kg}^{-1}$ WHP-P01 (47°N) 1999 - 1985

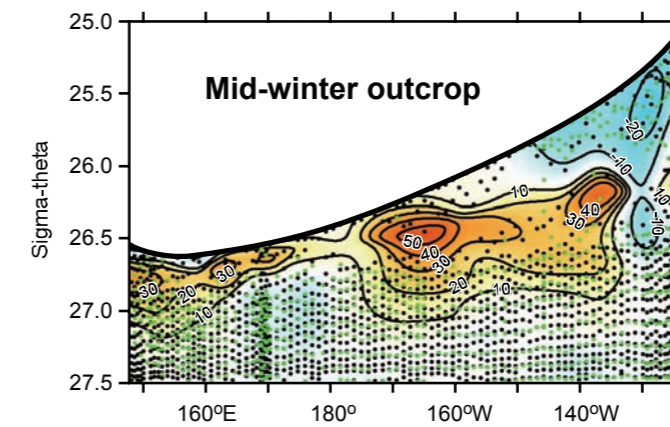

(b) $\Delta\text{AOU} / \mu\text{mol kg}^{-1}$ WHP-P01 (47°N) 2007 - 1999

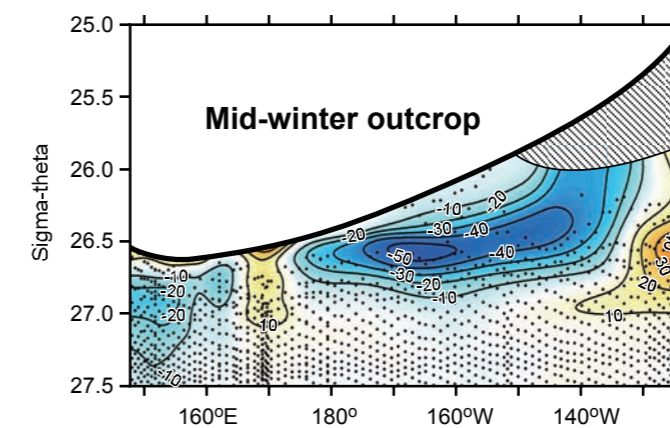

Figure 3.3.6 Distributions of differences of Apparent Oxygen Utilization, AOU ($\mu\text{mol kg}^{-1}$) against density (σ_θ) between 1985 and 1999 (a) and between 1999 and 2007 (b). Contour intervals are $10 \mu\text{mol kg}^{-1}$. Small dots indicate sampling layers for bottle oxygen. Sparse data hinder the comparison between 1999 and 2007 in shallow layers in the area to the east of 150°W (shaded area).

hand, that decreased by about $10 \mu\text{mol kg}^{-1}$ from 1993 to 2007 (Fig. 3.3.8) These results imply that the intermediate AOU increased by about $20 \mu\text{mol kg}^{-1}$ from 1993 to 1999, which is consistent with the AOU increase between 1985 and 1999 at the cross point (see Fig. 3.3.6a).

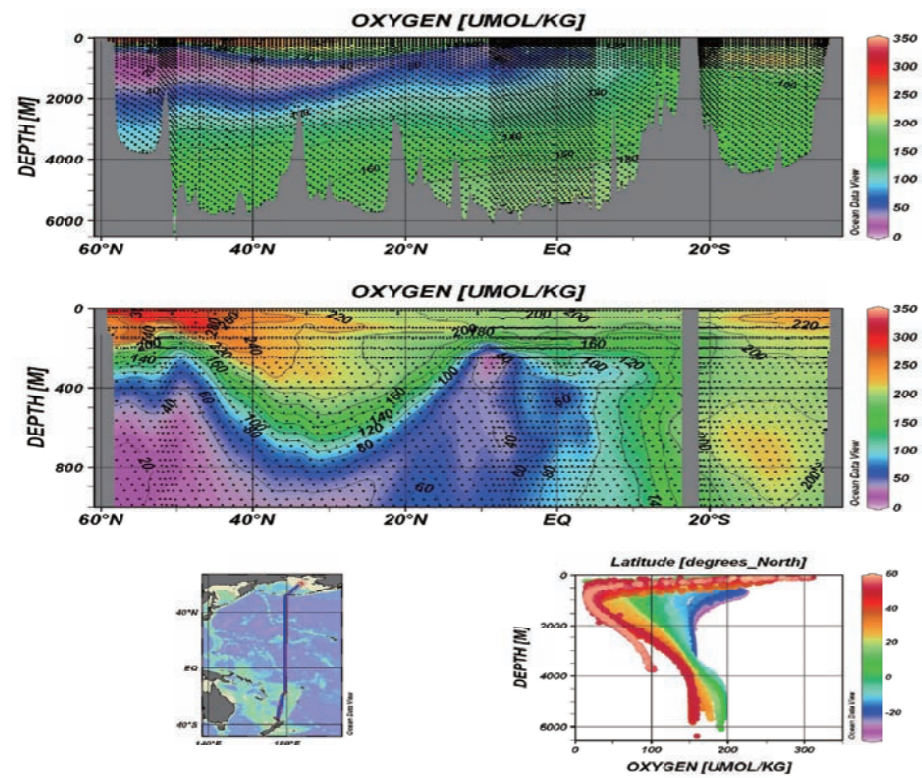

Figure 3.3.7 Meridional transects of dissolved oxygen along WHP-P14N/C in 2007 (Schlitzer, 2008).

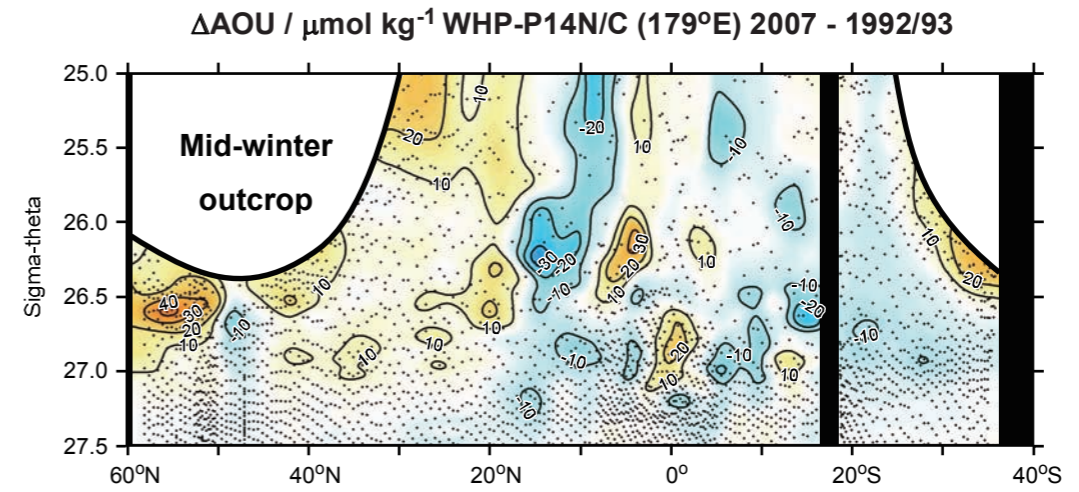

Figure 3.3.8 Distributions of differences of AOU ($\mu\text{mol kg}^{-1}$) against density (σ_θ) between 1992/93 and 2007. Contour intervals are $10 \mu\text{mol kg}^{-1}$. Small dots indicate sampling layers of dissolved oxygen in 2007.

References

- Dickson, A. (1996) Determination of dissolved oxygen in sea water by Winkler titration, in WHPO Pub. 91-1 Rev. 1, November 1994, Woods Hole, Mass., USA.
- DOE (1994) Handbook of methods for the analysis of the various parameters of the carbon dioxide system in sea water; version 2. A.G. Dickson and C. Goyet (eds), ORNL/CDIAC-74.
- Joyce, T., and C. Corry, eds., C. Corry, A. Dessier, A. Dickson, T. Joyce, M. Kenny, R. Key, D. Legler, R. Millard, R. Onken, P. Saunders, M. Stalcup, contrib. (1994) Requirements for WOCE Hydrographic Programme Data Reporting, WHPO Pub. 90-1 Rev. 2, May 1994 Woods Hole, Mass., USA.
- Schlitzer, R. (2008) Ocean Data View. WWW Page, <http://odv.awi.de>.
- Murray, C.N., J.P. Riley, and T.R.S. Wilson (1968) The solubility of oxygen in Winkler reagents used for determination of dissolved oxygen, Deep-Sea Res., 15, 237-238.

3.4 Nutrients

27 October 2008

(1) Personnel

MR0704 cruise

Michio AOYAMA (Meteorological Research Institute / Japan Meteorological Agency,
Principal Investigator)

Ayumi TAKEUCHI (Department of Marine Science, Marine Works Japan Ltd.)

Takayoshi SEIKE (Department of Marine Science, Marine Works Japan Ltd.)

Shunsuke MIYABE (Department of OD Science Technical Support, Marine Works Japan
Ltd.)

MR0706 cruise

Michio AOYAMA (Meteorological Research Institute / Japan Meteorological Agency,
Principal Investigator)

LEG 1

Ayumi TAKEUCHI (Department of Marine Science, Marine Works Japan Ltd.)

Junji MATSUSHITA (Department of Marine Science, Marine Works Japan Ltd.)

Kohei MIURA (Marine Works Japan Ltd.)

LEG 2

Kenichiro SATO (Department of Marine Science, Marine Works Japan Ltd.)

Takayoshi SEIKE (Department of Marine Science, Marine Works Japan Ltd.)

Kohei MIURA (Marine Works Japan Ltd.)

(2) Objectives

The objectives of nutrients analyses during the R/V MiraiMR0704 and MR0706 cruises, WOCE P1 and P14 revisited cruise in 2007, in the North Pacific are as follows;

- Describe the present status of nutrients concentration with excellent comparability.
- The determinants are nitrate, nitrite, phosphate and silicate.
- Study the temporal and spatial variation of nutrients concentration based on the previous high quality experiments data of WOCE previous P1 cruises in 1985 and 1999, P14N/C cruises in 1992, GOSECS, IGY and so on.
- Study of temporal and spatial variation of nitrate: phosphate ratio, so called Redfield ratio.
- Obtain more accurate estimation of total amount of nitrate, phosphate and silicate in the interested area.
- Provide more accurate nutrients data for physical oceanographers to use as tracers of water mass movement.

(3) Summary of nutrients analysis

We made 85 and 266 TRAACS800 runs for the samples at 88 in MR0704 and 273 stations in MR0706, respectively. The total amount of layers of the seawater sample reached up to 263 and 8319 for MR0704 and MR0706, respectively. We made duplicate measurement at all layers.

(4) Instrument and Method

(4.1) Analytical detail using TRAACS 800 systems (BRAN+LUEBBE)

The phosphate analysis is a modification of the procedure of Murphy and Riley (1962). Molybdc acid is added to the seawater sample to form phosphomolybdic acid which is in turn reduced to phosphomolybdous acid using L-ascorbic acid as the reductant.

Nitrate + nitrite and nitrite are analyzed according to the modification method of Grasshoff (1970). The sample nitrate is reduced to nitrite in a cadmium tube inside of which is coated with metallic copper. The sample stream with its equivalent nitrite is treated with an acidic, sulfanilamide reagent and the nitrite forms nitrous acid which reacts with the sulfanilamide to produce a diazonium ion. N-1-Naphthylethylene-diamine added to the sample stream then couples with the diazonium ion to produce a red, azo dye. With reduction of the nitrate to nitrite, both nitrate and nitrite react and are

measured; without reduction, only nitrite reacts. Thus, for the nitrite analysis, no reduction is performed and the alkaline buffer is not necessary. Nitrate is computed by difference.

The silicate method is analogous to that described for phosphate. The method used is essentially that of Grasshoff et al. (1983), wherein silicomolybdic acid is first formed from the silicate in the sample and added molybdic acid; then the silicomolybdic acid is reduced to silicomolybdous acid, or "molybdenum blue," using ascorbic acid as the reductant. The analytical methods of the nutrients during this cruise are similar with previous cruises (Uchida and Fukasawa, 2005).

The flow diagrams and reagents for each parameter are shown in Figures 3.4.1-3.4.4.

(4.2) Nitrate Reagents

Imidazole (buffer), 0.06 M (0.4 % w/v)

Dissolve 4 g imidazole, $C_3H_4N_2$, in ca. 1000 ml DIW; add 2 ml concentrated HCl. After mixing, 1 ml Triton(R)X-100 (50 % solution in ethanol) is added.

Sulfanilamide, 0.06 M (1 % w/v) in 1.2M HCl

Dissolve 10 g sulfanilamide, $4-NH_2C_6H_4SO_3H$, in 900 ml of DIW, add 100 ml concentrated HCl. After mixing, 2 ml Triton(R)X-100 (50 % solution in ethanol) is added.

N-1-Naphthylethylene-diamine dihydrochloride, 0.004 M (0.1 % w/v)

Dissolve 1 g NEDA, $C_{10}H_7NHCH_2CH_2NH_2 \cdot 2HCl$, in 1000 ml of DIW and add 10 ml concentrated HCl. Stored in a dark bottle.

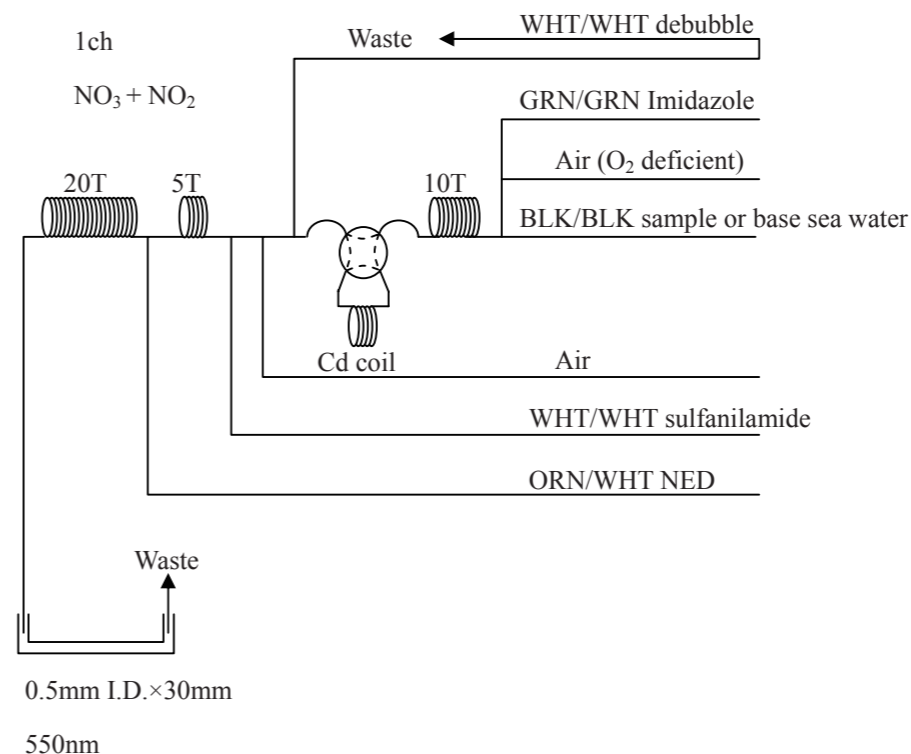

Figure 3.4.1: 1ch. (NO_3+NO_2) Flow diagram.

(4.3) Nitrite Reagents

Sulfanilamide, 0.06 M (1 % w/v) in 1.2 M HCl

Dissolve 10g sulfanilamide, $4-NH_2C_6H_4SO_3H$, in 900 ml of DIW, add 100 ml concentrated HCl. After mixing, 2 ml Triton(R)X-100 (50 % solution in ethanol) is added.

N-1-Naphthylethylene-diamine dihydrochloride, 0.004 M (0.1 % w/v)

Dissolve 1 g NEDA, $C_{10}H_7NHCH_2CH_2NH_2 \cdot 2HCl$, in 1000 ml of DIW and add 10 ml concentrated HCl. Stored in a dark bottle.

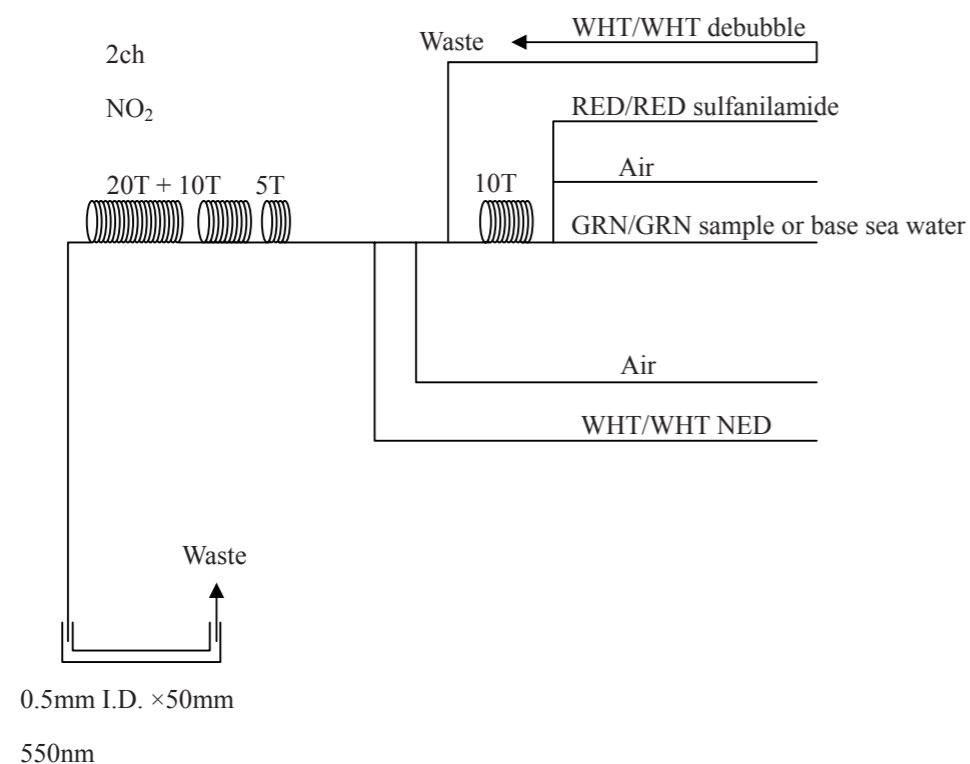

Figure3.4.2: 2ch. (NO₂) Flow diagram.

(4.4) Silicate Reagents

Molybdic acid, 0.06 M (2 % w/v)

Dissolve 15 g Disodium Molybdate(VI) Dihydrate, Na₂MoO₄ · 2H₂O, in 980 ml DIW, add 8 ml concentrated H₂SO₄. After mixing, 20 ml sodium dodecyl sulphate (15 % solution in water) is added.

Oxalic acid, 0.6 M (5 % w/v)

Dissolve 50g Oxalic Acid Anhydrous, HOOC: COOH, in 950 ml of DIW.

Ascorbic acid, 0.01M (3 % w/v)

Dissolve 2.5g L (+)-Ascorbic Acid, C₆H₈O₆, in 100 ml of DIW. Stored in a dark bottle and freshly prepared before every measurement.

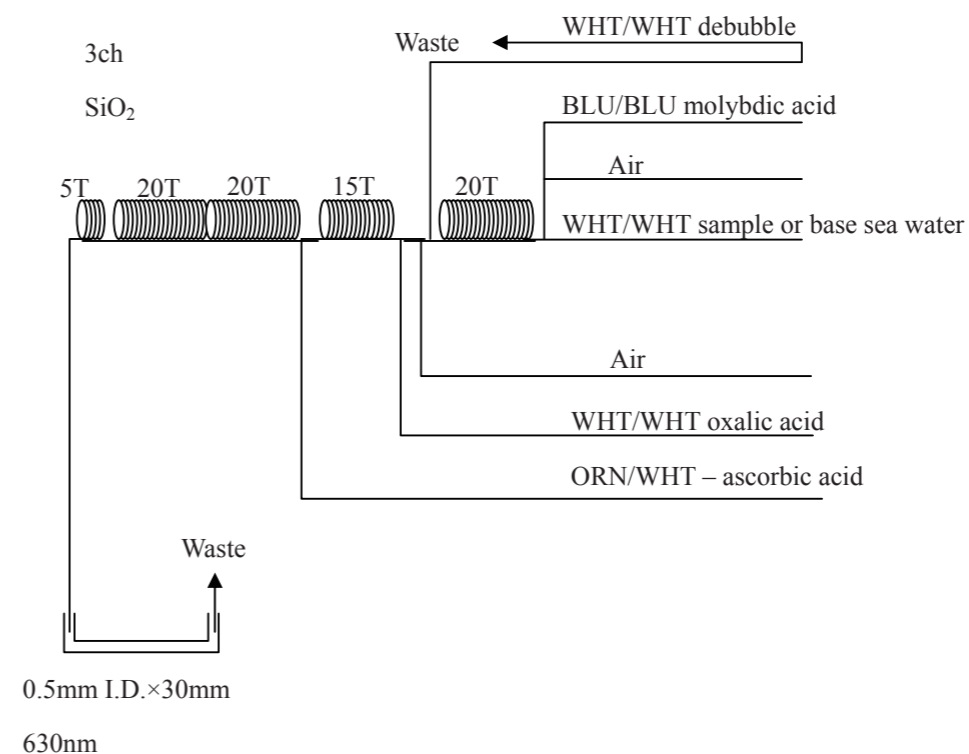

Figure3.4.3: 3ch. (SiO₂) Flow diagram.

(4.5) Phosphate Reagents

Stock molybdate solution, 0.03M (0.8 % w/v)

Dissolve 8 g Disodium Molybdate(VI) Dihydrate, Na₂MoO₄ · 2H₂O, and 0.17 g Antimony Potassium Tartrate, C₈H₄K₂O₁₂ Sb₂ · 3H₂O, in 950 ml of DIW and add 50 ml concentrated H₂SO₄.

Mixed Reagent

Dissolve 0.8 g L (+)-Ascorbic Acid, C₆H₈O₆, in 100 ml of stock molybdate solution. After mixing, 2 ml

sodium dodecyl sulphate (15 % solution in water) is added. Stored in a dark bottle and freshly prepared before every measurement.

Reagent for sample dilution

Dissolve Sodium Hydrate, NaCl, 10 g in ca. 950 ml of DIW, add 50 ml Acetone and 4 ml concentrated H₂SO₄. After mixing, 5 ml sodium dodecyl sulphate (15 % solution in water) is added.

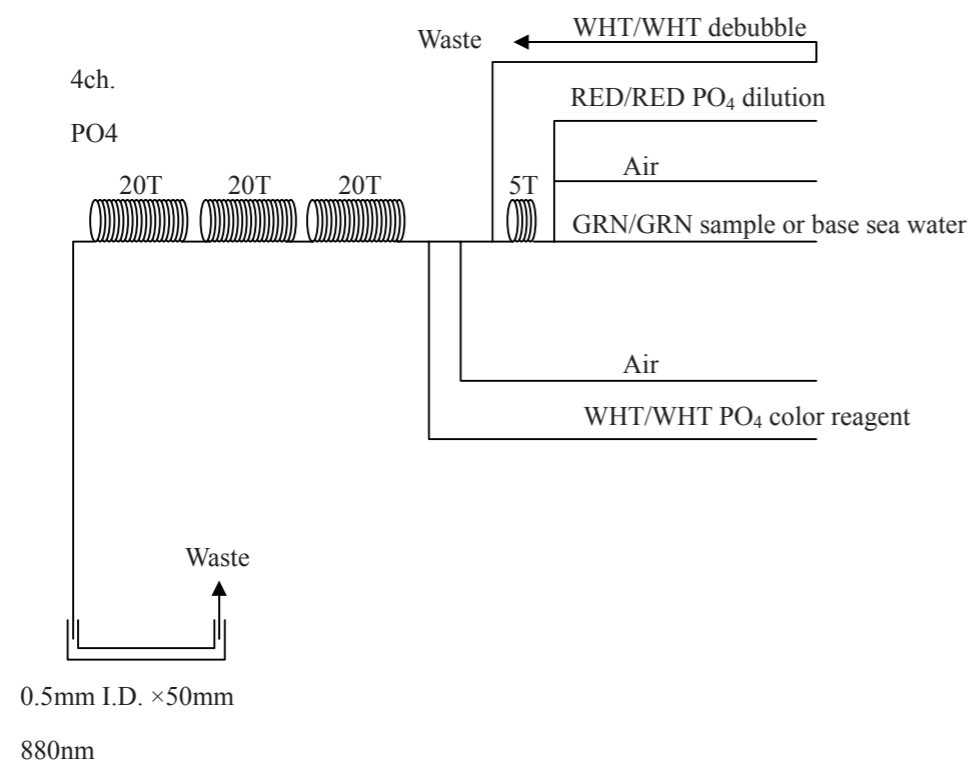

Figure3.4.4: 4ch. (PO₄) Flow diagram.

(4.6) Sampling procedures

Sampling of nutrients followed that oxygen, trace gases and salinity. Samples were drawn into two of virgin 10 ml polyacrylates vials without sample drawing tubes. These were rinsed three times before filling and vials were capped immediately after the drawing. The vials are put into water bath at

24 ± 1deg. C in 10 minutes before use to stabilize the temperature of samples in both MR0704 and MR0706.

No transfer was made and the vials were set an auto sampler tray directly. Samples were analyzed after collection basically within 20 hours in MR0704 and 14 hours in MR0706.

(4.7) Data processing

Raw data from TRAACS800 were treated as follows;

- Check baseline shift.
- Check the shape of each peak and positions of peak values taken, and then change the positions of peak values taken if necessary.
- Carry-over correction and baseline drift correction were applied to peak heights of each samples followed by sensitivity correction.
- Baseline correction and sensitivity correction were done basically using liner regression.
- Load pressure and salinity from CTD data to calculate density of seawater.
- Calibration curves to get nutrients concentration were assumed second order equations.

(5) Nutrients standards

(5.1) Volumetric Laboratory Ware of in-house standards

All volumetric glass- and polymethylpentene (PMP)-ware used were gravimetrically calibrated. Plastic volumetric flasks were gravimetrically calibrated at the temperature of use within 2-3 K.

Volumetric flasks

Volumetric flasks of Class quality (Class A) are used because their nominal tolerances are 0.05 % or less over the size ranges likely to be used in this work. Class A flasks are made of borosilicate glass, and the standard solutions were transferred to plastic bottles as quickly as possible after they are made up to volume and well mixed in order to prevent excessive dissolution of silicate from the glass.

High quality plastic (polymethylpentene, PMP, or polypropylene) volumetric flasks were gravimetrically calibrated and used only within 3-4 K of the calibration temperature.

The computation of volume contained by glass flasks at various temperatures other than the calibration temperatures were done by using the coefficient of linear expansion of borosilicate crown glass.

Because of their larger temperature coefficients of cubical expansion and lack of tables constructed for these materials, the plastic volumetric flasks were gravimetrically calibrated over the temperature range of intended use and used at the temperature of calibration within 3-4 K. The weights obtained in the calibration weightings were corrected for the density of water and air buoyancy.

Pipettes and pipettors

All pipettes have nominal calibration tolerances of 0.1 % or better. These were gravimetrically calibrated in order to verify and improve upon this nominal tolerance.

(5.2) Reagents, general considerations

Specifications

For nitrate standard, “potassium nitrate 99.995 suprapur” provided by Merck, CAS No. : 7757-91-1, was used.

For phosphate standard, “potassium dihydrogen phosphate anhydrous 99.995 suprapur” provided by Merck, CAS No. : 7778-77-0, was used.

For nitrite standard, “sodium nitrate” provided by Wako, CAS No. : 7632-00-0, was used. And assay of nitrite was determined according JIS K8019 and assays of nitrite salts were 99.1 %. We use that value to adjust the weights taken.

For the silicate standard, we use “Silicon standard solution SiO₂ in NaOH 0.5 mol/l CertiPUR” provided by Merck, CAS No. : 1310-73-2, of which lot number is HC623465 is used. The silicate concentration is certified by NIST-SRM3150 with the uncertainty of 0.5 %.

Ultra pure water

Ultra pure water (MilliQ water) freshly drawn was used for preparation of reagents, higher concentration standards and for measurement of reagent and system blanks.

Low-Nutrient Seawater (LNSW)

Surface water having low nutrient concentration was taken and filtered using 0.45 µm pore size membrane filter. This water is stored in 20 liter cubitainer with paper box. The concentrations of nutrient of this water were measured carefully in May 2007.

(5.3) Concentrations of nutrients for A, B and C standards

Concentrations of nutrients for A, B and C standards are set as shown in Table 3.4.1. The C standard is prepared according recipes as shown in Table 3.4.2. All volumetric laboratory tools were calibrated prior the cruise as stated in chapter (i). Then the actual concentration of nutrients in each fresh standard was calculated based on the ambient, solution temperature and determined factors of volumetric lab. wares.

Table 3.4.1 Nominal concentrations of nutrients for A, B and C standards.

	A	B	C-1	C-2	C-3	C-4	C-5	C-6	C-7
NO ₃ (µM)	45000	900	BA	AY	AX	AV	BF	55	BG
NO ₂ (µM)	4000	20	BA	AY	AX	AV	BF	1.2	BG
SiO ₂ (µM)	36000	2880	BA	AY	AX	AV	BF	170	BG
PO ₄ (µM)	3000	60	BA	AY	AX	AV	BF	3.6	BG

Table 3.4.2 Working calibration standard recipes.

C Std.	B-1 Std.	B-2 Std.
C-6	30 ml	30 ml

B-1 Std.: Mixture of nitrate, silicate and phosphate

B-2 Std.: Nitrite

(5.4) Renewal of in-house standard solutions.

In-house standard solutions as stated in (iii) were renewed as shown in Table 3.4.3.

Table 3.4.3 Timing of renewal of in-house standards.

NO₃, NO₂, SiO₂, PO₄	Renewal
A-1 Std. (NO₃)	maximum 1 month
A-2 Std. (NO₂)	maximum 1 month
A-3 Std. (SiO₂)	commercial prepared solution
A-4 Std. (PO₄)	maximum 1 month
B-1 Std. (mixture of NO₃, SiO₂, PO₄)	8 days
B-2 Std. (NO₂)	8 days
C Std.	Renewal
C-6 Std. (mixture of B-1 and B-2 Std.)	24 hours
Reduction estimation	Renewal
D-1 Std. (7200µM NO₃)	when A-1 Std. renewed
43µM NO₃	when C Std. renewed
47µM NO₂	when C Std. renewed

(6) Reference material of nutrients in seawater

To get the more accurate and high quality nutrients data to achieve the objectives stated above, huge numbers of the bottles of the reference material of nutrients in seawater (hereafter RMNS) are prepared (Aoyama et al., 2007). In the previous world wide expeditions, such as WOCE cruises, the higher reproducibility and precision of nutrients measurements were required (Joyce and Corry, 1994). Since no standards were available for the measurement of nutrients in seawater at that time, the requirements were described in term of reproducibility. The required reproducibility was 1 %, 1-2 %, 1-3 % for nitrate, phosphate and silicate, respectively. Although nutrient data from the WOCE one-time survey was of unprecedented quality and coverage due to much care in sampling and measurements, the differences of nutrients concentration at crossover points are still found among the expeditions (Aoyama and Joyce, 1996, Mordy et al., 2000, Gouretski and Jancke, 2001). For instance, the mean offset of nitrate concentration at deep waters was 0.5 µmol kg⁻¹ for 345 crossovers at world oceans, though the maximum was 1.7 µmol kg⁻¹ (Gouretski and Jancke, 2001). At the 31 crossover points in the Pacific WHP one-time lines, the WOCE standard of reproducibility for nitrate of 1 % was fulfilled at about half of the crossover points and the maximum difference was 7 % at deeper layers below 1.6 deg. C in potential temperature (Aoyama and Joyce, 1996).

(6.1) RMNSs for this cruise

RMNS lots BA, AY, AX, AV and BF, which cover full range of nutrients concentrations in the western North Pacific Ocean are prepared. 40 sets of BA, AY, AX, AV and BF are prepared.

Since silicate concentration along P1 section was expected to be very high, we also prepared RMNS lot BG, of which silicate concentration is 255 µmol kg⁻¹. When silicate concentration expected to exceed 170 µmol kg⁻¹, we add RMNS lot BG as an additional standard as C-7. These RMNSs were renewed daily and analyzed every 2 runs on the same day.

Eighty-five and 266 bottles of RMNS lot BC are prepared for MR0704 and MR0706,

respectively, to use every analysis at every hydrographic station. These RMNS assignment were completely done based on random number. The RMNS bottles were stored at a room in the ship, REAGENT STORE, where the temperature was maintained around 24-26 deg. C.

(6.2) Assigned concentration for RMNSs

We assigned nutrients concentrations for RMNS lots BA, AY, AX, AV, BF, BC and BG as shown in Table 3.4.4.

Table 3.4.4 Assigned concentration of RMNSs.

	unit: $\mu\text{mol kg}^{-1}$			
	Nitrate	Phosphate	Silicate	Nitrite
AH	35.31	2.114	132.20	(0.02)*
BA	0.07	0.068	1.60	0.02
AY	5.60	0.516	29.42	0.62
AX	21.42	1.619	58.06	0.35
AV	33.36	2.516	154.14	0.10
BF	41.39	2.809	150.61	0.02
BC	40.71	2.782	156.13	0.02
BG	36.85	2.570	254.42	0.06

* Concentration of nitrite for lot. AH did not assign. The value in the table is result of measurement on 7 Oct. 2007.

(6.3) The homogeneity of RMNSs

The homogeneity of lot BC and analytical precisions are shown in Table 3.4.5. These are for the assessment of the magnitude of homogeneity of the RMNS bottles those are used during the cruise. As shown in Table 3.4.5 and Table 3.4.6 the homogeneity of RMNS lot BC for nitrate and silicate are the same magnitude of analytical precision derived from fresh raw seawater in May 2005. The homogeneity

for phosphate, however, exceeded the analytical precision at some extent. In May 2007, analytical precisions become better less than 0.1 % and the homogeneity at lot BF and BG for nitrate, phosphate and silicate were 0.11-0.14 %, 0.17-0.21 %, 0.08-0.10 %, respectively.

Table 3.4.5 Homogeneity of lot BC and previous lots derived from simultaneous 30 samples measurements and an analytical precision onboard R/V Mirai in May 2005.

	Nitrate	Phosphate	Silicate
	CV %	CV %	CV %
BC	0.22	0.32	0.19
(AH)	(0.39)	(0.83)	(0.13)
(K)	(0.3)	(1.0)	(0.2)
Precision	0.22	0.22	0.12

Note: N=30 × 2

Table 3.4.6 Homogeneity of lot BF and BG derived from simultaneous 7 samples measurements and analytical precision onboard R/V Mirai in May 2007.

	Nitrate	Phosphate	Silicate
	CV %	CV %	CV %
BF	0.11	0.21	0.10
BG	0.14	0.17	0.08
Precision	0.05	0.07	0.06

Note: N=7 × 4

(6.4) Comparability of RMNSs during the periods from 2003 to 2007

Cruise-to-cruise comparability has examined based on the results of the previous results of RMNSs measurements obtained among cruises, and RMNS international comparison experiments in 2003 and 2006. The uncertainties for each value were obtained similar method described in 7.1 in this chapter at the measurement before each cruise and inter-comparison study, shown as precruise and

intercomparison, and mean of uncertainties during each cruise, only shown cruise code, respectively. As shown in Table 3.4.7, the nutrients concentrations of RMNSs were in good agreement among the measurements during the period from 2003 to 2007. For the silicate measurements, we show lot numbers and chemical company names of each cruise/measurement in the footnote. As shown in Table 3.4.7, there shows less comparability among the measurements due to less comparability among the standard solutions provided by chemical companies in the silicate measurements.

Table 3.4.7 (a) Comparability for nitrate.

unit: $\mu\text{mol kg}^{-1}$

Cruise/Lab	RM Lots													
	AH	unc.	BA	unc.	AY	unc.	AX	unc.	AV	unc.	BF	unc.	BC	unc.
Nitrate														
2003														
2003intercomparison	35.23													
2005														
MR05-01	35.54	0.08	0.05	0.03			21.49	0.09	33.38	0.08				
MR05-02			0.07	0.02	5.61	0.02	21.45	0.07	33.35	0.06			40.70	0.06
MR05-05_1precruise	35.65	0.05	0.07	0.00	5.57	0.00	21.41	0.01	33.41	0.02			40.76	0.03
MR05-05_1			0.07	0.01	5.62	0.02	21.43	0.05	33.36	0.05			40.73	0.85
MR05-05_2 precruise			0.08	0.00	5.58	0.00	21.39	0.02	33.36	0.03			40.72	0.03
MR05-05_2			0.07	0.01	5.62	0.02	21.44	0.05	33.36	0.05			40.73	0.06
MR05-05_3 precruise			0.06	0.00	5.62	0.00	21.49	0.01	33.39	0.01			40.79	0.01
MR05-05_3			0.07	0.01	5.61	0.02	21.44	0.04	33.37	0.05			40.75	0.05
2006														
MR06-02_precruise					5.62	0.00			33.36	0.01				
MR06-03 precruise					5.59	0.00			33.42	0.02				

MR06-03_2precruise					5.62	0.00			33.24	0.02				
MR06-04_1precruise					5.60	0.01			33.33	0.04				
MR06-04_2precruise					5.58	0.01			33.12	0.04				
RM Lots														
Cruise/Lab	AH	unc.	BA	unc.	AY	unc.	AX	unc.	AV	unc.	BF	unc.	BC	unc.
Nitrate														
MR06-05_1precruise			0.07	0.00	5.61	0.00	21.42	0.01	33.28	0.01			40.63	0.02
2006intercomparison			0.04	0.00	5.58	0.01	21.40	0.02	33.32	0.03			40.63	0.04
2003intercomp_revisit	35.4	0.03												
2007														
MR07-01_precruise			0.04	0.00	5.59	0.01	21.38	0.04	33.31	0.06			40.60	0.07
MR07-02_precruise			0.04	0.00	5.62	0.01	21.44	0.02	33.40	0.03	41.36	0.04		
MR07-04_precruise_1	35.74	0.03	0.07	0.00	5.67	0.00	21.59	0.02	33.49	0.03	41.47	0.03	40.83	0.03
MR07-04_precruise_2	35.80	0.01	0.08	0.00	5.65	0.00	21.60	0.01	33.47	0.01	41.55	0.02	40.92	0.02
MR07-04			0.08	0.01	5.61	0.02	21.41	0.06	33.38	0.05	41.36	0.06	40.77	0.05
MR07-05_precruise			0.08	0.00	5.65	0.01	21.43	0.02	33.44	0.04	41.46	0.05	40.87	0.04
MR07-06_1precruise	35.61	0.02	0.07	0.00	5.61	0.00	21.44	0.01	33.43	0.02	41.44	0.02	40.79	0.02
MR07-06_1			0.08	0.01	5.62	0.04	21.44	0.03	33.41	0.05	41.36	0.04	40.81	0.04
MR07-06_2precruise	35.61	0.04	0.06	0.00	5.62	0.01	21.43	0.02	33.54	0.04	41.42	0.05	40.79	0.05
MR07-06_2			0.08	0.01	5.61	0.02	21.44	0.03	33.39	0.06	41.36	0.05	40.81	0.04

Table 3.4.7 (b) Comparability for phosphate.

unit: $\mu\text{mol kg}^{-1}$

Cruise/Lab	RM Lots													
	AH	unc.	BA	unc.	AY	unc.	AX	unc.	AV	unc.	BF	unc.	BC	unc.
	Phosphate													
2003														
2003intercomp	2.1													
2005														
MR05-01	2.133	0.023	0.065	0.006			1.622	0.008	2.52	0.007				
MR05-02			0.061	0.010	0.515	0.009	1.614	0.008	2.515	0.008			2.778	0.010
MR05-05_1precruise	2.148	0.006	0.045	0.000	0.508	0.000	1.620	0.001	2.517	0.002			2.781	0.002
MR05-05_1			0.063	0.007	0.515	0.007	1.615	0.006	2.515	0.007			2.778	0.033
MR05-05_2 precruise			0.066	0.000	0.519	0.000	1.608	0.001	2.510	0.001			2.784	0.002
MR05-05_2			0.064	0.005	0.517	0.005	1.614	0.004	2.515	0.005			2.782	0.006
MR05-05_3 precruise			0.060	0.000	0.519	0.000	1.620	0.001	2.517	0.002			2.788	0.002
MR05-05_3			0.061	0.004	0.514	0.003	1.618	0.005	2.515	0.004			2.779	0.008
2006														
MR06-02_precruise					0.516	0.000			2.515	0.002				
MR06-03 precruise					0.496	0.001			2.499	0.003				
MR06-03_2precruise					0.504	0.001			2.515	0.003				
MR06-04_1precruise					0.502	0.000			2.501	0.002				
MR06-04_2precruise					0.508	0.000			2.507	0.002				
MR06-05_1precruise			0.071	0.000	0.527	0.000	1.629	0.000	2.523	0.001			2.788	0.001
2006intercomparison			0.071	0.000	0.524	0.000	1.623	0.001	2.515	0.002			2.791	0.002
2003intercomp_revisit	2.141	0.001												
2007														

Cruise/Lab	RM Lots													
	AH	unc.	BA	unc.	AY	unc.	AX	unc.	AV	unc.	BF	unc.	BC	unc.
	Phosphate													
MR07-01_precruise			0.073	0.000	0.524	0.001	1.620	0.002	2.521	0.003			2.784	0.003
MR07-02_precruise			0.080	0.000	0.593	0.000	1.646	0.001	2.553	0.002	2.832	0.002		
MR07-04_precruise_1	2.140	0.002	0.062	0.000	0.518	0.000	1.620	0.001	2.512	0.002	2.811	0.002	2.782	0.002
MR07-04_precruise_2	2.146	0.002	0.056	0.000	0.514	0.000	1.620	0.001	2.517	0.002	2.811	0.002	2.788	0.002
MR07-04			0.066	0.004	0.521	0.005	1.617	0.005	2.513	0.004	2.805	0.006	2.781	0.007
MR07-05_precruise			0.052	0.000	0.506	0.001	1.618	0.002	2.508	0.003	2.804	0.003	2.794	0.003
MR07-06_1precruise	2.144	0.001	0.066	0.000	0.520	0.000	1.617	0.001	2.517	0.001	2.806	0.001	2.790	0.001
MR07-06_1			0.064	0.004	0.519	0.005	1.620	0.003	2.515	0.003	2.808	0.003	2.783	0.005
MR07-06_2precruise	2.146	0.002	0.067	0.000	0.520	0.000	1.620	0.001	2.517	0.002	2.808	0.002	2.789	0.002
MR07-06_2			0.066	0.004	0.521	0.005	1.619	0.005	2.515	0.003	2.807	0.004	2.785	0.006

Table 3.4.7 (c) Comparability for silicate.

unit: $\mu\text{mol kg}^{-1}$

Cruise/Lab	RM Lots													
	AH	unc.	BA	unc.	AY	unc.	AX	unc.	AV	unc.	BF	unc.	BC	unc.
	Silicate													
2003														
2003intercomparison**	133.97													
2005														
MR05-01#	135.42	0.20	1.58	0.06			59.42	0.07	157.71	0.19				
MR05-02#			1.65	0.05	30.15	0.08	59.53	0.11	157.87	0.19			159.93	0.19
MR05-05_1precruise##	135.89	0.13	1.55	0.00	30.13	0.02	59.55	0.03	157.92	0.09			160.05	0.09
MR05-05_1##			1.63	0.07	30.11	0.08	59.50	0.12	157.96	0.26			160.08	0.36
MR05-05_2 precruise##			1.62	0.00	30.12	0.02	59.46	0.04	158.02	0.09			160.22	0.10
MR05-05_2##			1.63	0.06	30.11	0.07	59.49	0.09	158.00	0.16			160.14	0.15
MR05-05_3 precruise##			1.61	0.00	30.13	0.03	59.54	0.05	158.02	0.14			160.12	0.14
MR05-05_3##			1.64	0.05	30.12	0.05	59.47	0.09	157.93	0.18			160.08	0.13
2006														
MR06-02_precruise##					30.21	0.02			158.14	0.12				
MR06-03 precruise †					29.39	0.02			154.47	0.10				
MR06-03_2precruise †					29.56	0.01			154.52	0.08				
MR06-04_1precruise †					29.50	0.00			154.31	0.02				
MR06-04_2precruise †					29.44	0.01			153.98	0.03				
MR06-05_1precruise***			1.67	0.00	29.62	0.02	58.32	0.04	154.15	0.11			156.10	0.11
2006intercomparison †			1.64	0.00	29.50	0.01	58.18	0.03	154.33	0.08			156.31	0.08
2003intercomp_revisit †	132.55	0.07												
2007														

Cruise/Lab	RM Lots													
	AH	unc.	BA	unc.	AY	unc.	AX	unc.	AV	unc.	BF	unc.	BC	unc.
	Silicate													
MR07-01_precruise †			1.59	0.00	29.37	0.03	57.99	0.06	154.21	0.15			156.06	0.16
MR07-02_precruise †			1.65	0.00	29.60	0.02	58.37	0.04	154.55	0.09	150.57	0.09		
MR07-04_precruise_1 S	133.38	0.06	1.61	0.00	29.57	0.01	58.46	0.03	154.82	0.07	151.03	0.07	156.98	0.07
MR07-04_precruise_2 S	133.15	0.12	1.69	0.00	29.61	0.03	58.44	0.05	154.87	0.14	151.04	0.14	156.86	0.14
MR07-04 S			1.62	0.07	29.42	0.07	58.11	0.11	154.45	0.21	150.59	0.16	156.62	0.48
MR07-05_precruise S			1.70	0.00	29.43	0.02	58.08	0.04	154.05	0.11	150.48	0.11	156.31	0.11
MR07-06_1precruise S	133.02	0.09	1.64	0.00	29.72	0.02	58.50	0.04	155.06	0.11	150.31	0.11	156.33	0.11
MR07-06_1 S			1.61	0.04	29.43	0.07	58.13	0.08	154.48	0.13	150.53	0.11	156.64	0.08
MR07-06_2precruise S	132.70	0.07	1.56	0.00	29.48	0.01	58.25	0.03	154.39	0.08	150.56	0.08	156.57	0.08
MR07-06_2 S			1.58	0.07	29.35	0.08	58.04	0.10	154.38	0.16	150.49	0.13	156.61	0.13

List of lot numbers: *: Kanto 306F9235; **: Kanto 402F9041; #: Kanto 502F9205; ##: Kanto 609F9157; †: Merck OC551722; ***: Merck HC694149; \$: Merck HC623465

(7) Quality control

(7.1) Precision of nutrients analyses during the cruise

MR0704

Precision of nutrients analyses during the cruise was evaluated based on the 11 measurements, which are measured every 12 samples, during a run at the concentration of C-6 std. We also evaluated the reproducibility based on the replicate analyses of five samples in each run. Summary of precisions are shown in Table 3.4.8. As shown in Table 3.4.8 and Figures 3.4.5-3.4.7, the precisions for each parameter are generally good considering the analytical precisions estimated from the simultaneous analyses of 12 samples in May 2007. Analytical precisions previously evaluated were 0.05 % for nitrate, 0.07 % for phosphate and 0.06 % for silicate, respectively. During this cruise, analytical precisions

were 0.06 % for nitrate, 0.10 % for phosphate and 0.07 % for silicate in terms of median of precision, respectively. Then we can conclude that the analytical precisions for nitrate, phosphate and silicate were maintained throughout this cruise. The time series of precision are shown in Figures 3.4.5-3.4.7.

Table 3.4.8 Summary of precision based on the replicate analyses of 11 samples in each run through out cruise.

	Nitrate	Phosphate	Silicate
	CV %	CV %	CV %
Median	0.06	0.10	0.07
Mean	0.06	0.10	0.07
Maximum	0.12	0.19	0.12
Minimum	0.02	0.03	0.01
N	85	85	85

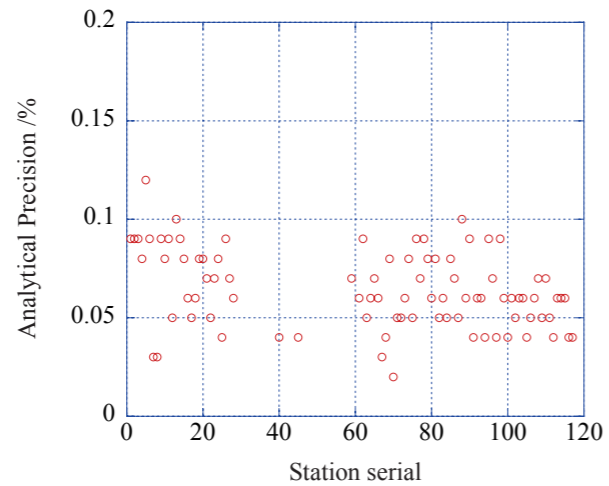

Figure 3.4.5 Time series of p precision of nitrate for MR0704.

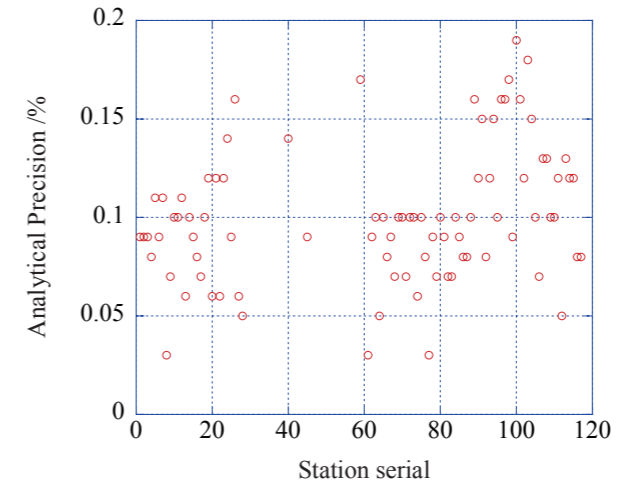

Figure 3.4.6 Time series of p precision of phosphate for MR0704.

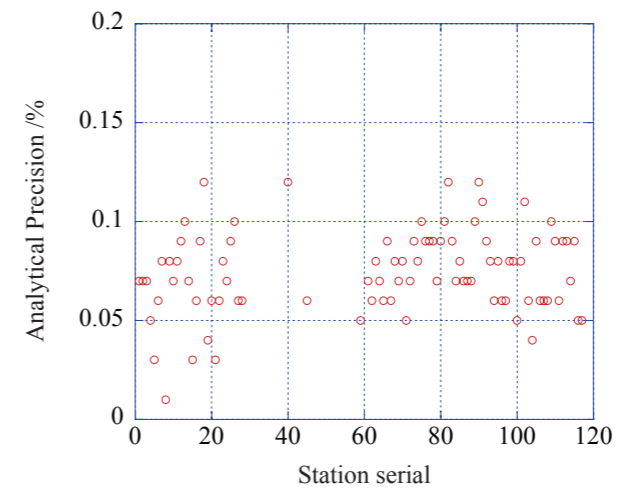

Figure 3.4.7 Time series of p precision of silicate for MR0704.

MR0706

Precision of nutrients analyses during the cruise was evaluated based on the 11 measurements, which are measured every 12 samples, during a run at the concentration of C-6 std. We also evaluated the reproducibility based on the replicate analyses of five samples in each run. Summary of precisions are shown in Table 3.4.9. As shown in Table 3.4.9 and Figures 3.4.8-3.4.10, the precisions for each parameter are generally good considering the analytical precisions estimated from the simultaneous analyses of 12 samples in May 2007. Analytical precisions previously evaluated were 0.05 % for nitrate, 0.07 % for phosphate and 0.06 % for silicate, respectively. During this cruise, analytical precisions were 0.07 % for nitrate, 0.09 % for phosphate and 0.07 % for silicate in terms of median of precision, respectively. Then we can conclude that the analytical precisions for nitrate, phosphate and silicate were maintained throughout this cruise. The time series of precision are shown in Figures 3.4.8-3.4.10.

Table 3.4.9 Summary of precision based on the replicate analyses of 11 samples in each run throughout cruise.

	Nitrate	Phosphate	Silicate
	CV %	CV %	CV %
Median	0.07	0.09	0.07
Mean	0.07	0.10	0.07
Maximum	0.15	0.20	0.16
Minimum	0.02	0.03	0.02
N	266	266	266

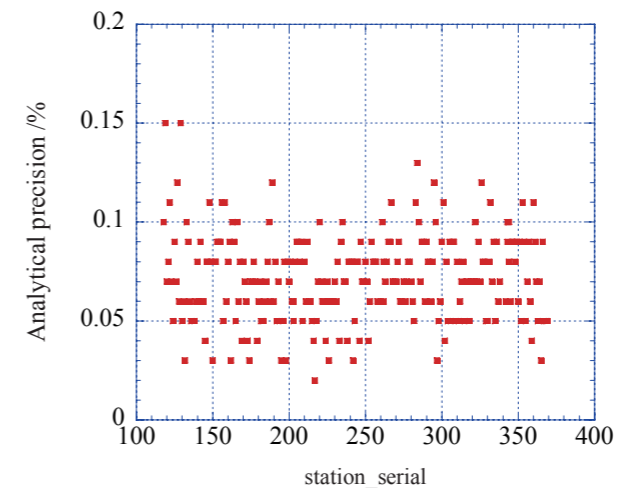

Figure 3.4.8 Time series of p recision of nitrate for MR0706.

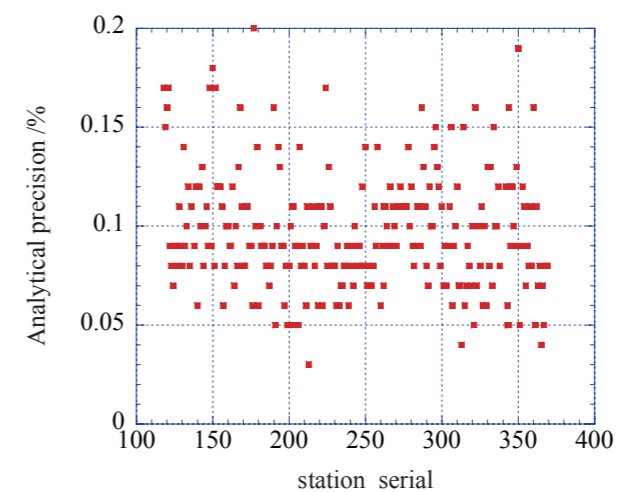

Figure 3.4.9 Time series of p recision of phosphate for MR0706.

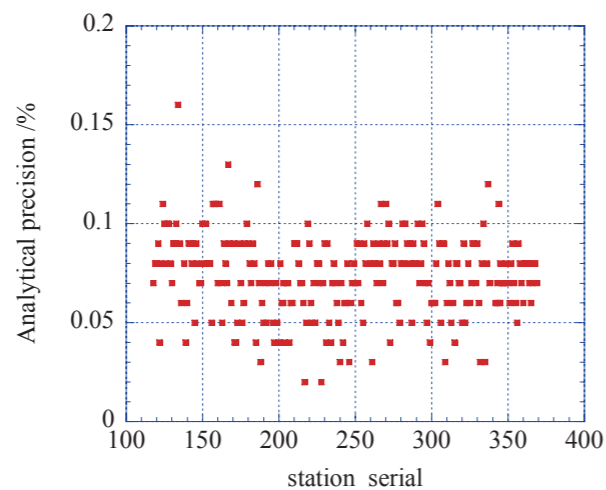

Figure 3.4.10 Time series of precision of silicate for MR0706.

(7.2) Carry over

We can also summarize the magnitudes of carry over throughout the cruise. These are small enough within acceptable levels as shown in Table 3.4.10.

Table 3.4.10 (a) Summary of carry over throughout MR0704 cruise.

	Nitrate	Phosphate	Silicate
	CV %	CV %	CV %
Median	0.16	0.11	0.20
Mean	0.16	0.13	0.20
Maximum	0.28	0.44	0.36
Minimum	0.02	0.00	0.07
N	85	85	85

Table 3.4.10(b) Summary of carry over throughout MR0706 cruise.

	Nitrate	Phosphate	Silicate
	CV %	CV %	CV %
Median	0.14	0.14	0.12
Mean	0.14	0.14	0.13
Maximum	0.33	0.40	0.29
Minimum	0.00	0.00	0.01
N	266	266	266

(8) Problems/improvements occurred and solutions.

MR0704

During the analysis for the samples between station 8 and station 27 of WHP-P1, we got a problem on phosphate measurements. 17 samples from 8 stations showed large difference on duplicate measurements exceeding uncertainty of $0.02 \mu\text{mol kg}^{-1}$.

Especially 12 samples showed 0.05 to $0.97 \mu\text{mol kg}^{-1}$ higher values. We had judged that these higher values are contamination during the sampling from Niskin bottle or test tube itself. Therefore, we had checked probable source of this contamination including air-conditioners in the water sampling room and the laboratory. For the air-conditioners, we had cleaned up them. For the test tubes, we had made blank test for 440 tubes.

We did not see any contaminations on test tubes. Since higher phosphate concentration did not occur after we clean up the air-conditioners, we had concluded that the source of the contamination of phosphate might be one of air-conditioners in the Lab.

MR0706

No problem occurred during this cruise.

References

- Aminot, A. and Kerouel, R. 1991. Autoclaved seawater as a reference material for the determination of nitrate and phosphate in seawater. *Anal. Chim. Acta*, 248: 277-283.
- Aminot, A. and Kirkwood, D.S. 1995. Report on the results of the fifth ICES intercomparison exercise for nutrients in sea water, ICES coop. Res. Rep. Ser., 213.
- Aminot, A. and Kerouel, R. 1995. Reference material for nutrients in seawater: stability of nitrate, nitrite, ammonia and phosphate in autoclaved samples. *Mar. Chem.*, 49: 221-232.
- Aoyama M., and Joyce T.M. 1996, WHP property comparisons from crossing lines in North Pacific. In Abstracts, 1996 WOCE Pacific Workshop, Newport Beach, California.
- Aoyama, M., Ota, H., Iwano, S., Kamiya, H., Kimura, M., Masuda, S., Nagai, N., Saito, K., Tubota, H. 2004. Reference material for nutrients in seawater in a seawater matrix, *Mar. Chem.*, submitted.
- Aoyama, M., Susan B., Minhan, D., Hideshi, D., Louis, I. G., Kasai, H., Roger, K., Nurit, K., Doug, M., Murata, A., Nagai, N., Ogawa, H., Ota, H., Saito, H., Saito, K., Shimizu, T., Takano, H., Tsuda, A., Yokouchi, K., and Agnes, Y. 2007. Recent Comparability of Oceanographic Nutrients Data: Results of a 2003 Intercomparison Exercise Using Reference Materials. *Analytical Sciences*, 23: 1151-1154.
- Grasshoff, K., Ehrhardt, M., Kremling K. et al. 1983. *Methods of seawater analysis*. 2nd rev. Weinheim: Verlag Chemie, Germany, West.
- Uchida, H. & Fukasawa, M. WHP P6, A10, I3/I4 REVISIT DATA BOOK Blue Earth Global Expedition 2003 1, 2, (Aiwa Printing Co., Ltd., Tokyo, 2005).
- Joyce, T. and Corry, C. 1994. Requirements for WOCE hydrographic programmed data reporting. WHPO Publication, 90-1, Revision 2, WOCE Report No. 67/91.
- Kirkwood, D.S. 1992. Stability of solutions of nutrient salts during storage. *Mar. Chem.*, 38 : 151-164.
- Kirkwood, D.S. Aminot, A. and Perttila, M. 1991. Report on the results of the ICES fourth intercomparison exercise for nutrients in sea water. ICES coop. Res. Rep. Ser., 174.
- Mordy, C.W., Aoyama, M., Gordon, L.I., Johnson, G.C., Key, R.M., Ross, A.A., Jennings, J.C. and Wilson. J. 2000. Deep water comparison studies of the Pacific WOCE nutrient data set. *Eos Trans-American Geophysical Union*. 80 (supplement), OS43.
- Murphy, J., and Riley, J.P. 1962. *Analytica chim. Acta* 27, 31-36.
- Gouretski, V.V. and Jancke, K. 2001. Systematic errors as the cause for an apparent deep water property variability: global analysis of the WOCE and historical hydrographic data • REVIEW ARTICLE, *Progress In Oceanography*, 48: Issue 4, 337-402.

3.5. Dissolved inorganic carbon (C_T)

9 November 2008

(1) Personnel

Akihiko Murata (IORGC/JAMSTEC)

Yoshiko Ishikawa (MWJ)

Yasuhiro Arii (MWJ)

Mikio Kitada (MWJ)

(2) Objectives

Concentrations of CO_2 in the atmosphere are now increasing at a rate of 1.5 ppmv y^{-1} due to human activities such as burning of fossil fuels, deforestation, cement production, etc. It is an urgent task to estimate as accurately as possible the absorption capacity of the oceans against the increased atmospheric CO_2 , and to clarify the mechanism of the CO_2 absorption, because the magnitude of the predicted global warming depends on the levels of CO_2 in the atmosphere, and because the ocean currently absorbs 1/3 of the 6 Gt of carbon emitted into the atmosphere each year by human activities.

In the cruises (MR07-04 and MR07-06, revisit of WOCE P1 and P14 lines) using the R/V Mirai, we were aimed at quantifying how much anthropogenic CO_2 is absorbed in the Pacific Ocean. For the purpose, we measured CO_2 -system properties such as dissolved inorganic carbon (C_T), total alkalinity (A_T), pH and underway pCO_2 .

In this section, we describe data on C_T obtained in the cruise in detail.

(3) Apparatus

Measurements of C_T were made with two total CO_2 measuring systems (systems-A and -C; Nippon ANS, Inc.), which are slightly different from each other. The systems comprise of a seawater dispensing

system, a CO_2 extraction system and a coulometer (Model 5012, UIC Inc.).

The seawater dispensing system has an auto-sampler (6 ports), which takes seawater from a 300 ml borosilicate glass bottle and dispenses the seawater to a pipette of nominal 20 or 26 ml volume by a PC control. The pipette is kept at $20 \text{ }^\circ\text{C}$ by a water jacket, where water from a water bath set at $20 \text{ }^\circ\text{C}$ is circulated.

CO_2 dissolved in a seawater sample is extracted in a stripping chamber of a CO_2 extraction system by adding phosphoric acid (10% v/v). The stripping chamber is approx. 25 cm long and has a fine frit at the bottom. The acid is added to the stripping chamber from the bottom of the chamber by pressurizing an acid bottle for a given time to push out a right amount of acid. The pressurizing is made with nitrogen gas (99.9999 %). After the acid is transferred to the stripping chamber, a seawater sample kept in a pipette is introduced to the stripping chamber by the same method as in adding an acid. The seawater reacted with phosphoric acid is stripped of CO_2 by bubbling the nitrogen gas through a fine frit at the bottom of the stripping chamber. The CO_2 stripped in the stripping chamber is carried by the nitrogen gas (140 ml min^{-1} for the systems-A and -C) to the coulometer through a dehydrating module. For the system-A, the module consists of two electric dehumidifiers (kept at $1 - 2 \text{ }^\circ\text{C}$) and a chemical desiccant ($Mg(ClO_4)_2$). For the system-C, it consists of three electric dehumidifiers with a chemical desiccant.

(4) Shipboard measurement

(4.1) Sampling

All seawater samples were collected from depth with 12 liter Niskin bottles basically at every other stations. The seawater samples for C_T were taken with a plastic drawing tube (PFA tubing connected to silicone rubber tubing) into a 300 ml borosilicate glass bottle. The glass bottle was filled with seawater smoothly from the bottom following a rinse with a seawater of 2 full, bottle volumes. The glass bottle was closed by a stopper, which was fitted to the bottle mouth gravimetrically without additional force.

At a chemical laboratory on the ship, a headspace of approx. 1 % of the bottle volume was made by removing seawater with a plastic pipette. A saturated mercuric chloride of $100 \text{ } \mu\text{l}$ was added to poison

seawater samples. The glass bottles were sealed with a greased (Apiezon M, M&I Materials Ltd) ground glass stopper and the clips were secured. The seawater samples were kept at 4 °C in a refrigerator until analysis. A few hours just before analysis, the seawater samples were kept at 20 °C in a water bath.

(4.2) Analysis

At the start of each leg, we calibrated the measuring systems by blank and 5 kinds of Na₂CO₃ solutions (nominally 500, 1000, 1500, 2000, 2500 μmol/L). As it was empirically known that coulometers do not show a stable signal (low repeatability) with fresh (low absorption of carbon) coulometer solutions. Therefore we measured 2% CO₂ gas repeatedly until the measurements became stable. Then we started the calibration.

The measurement sequence such as system blank (phosphoric acid blank), 2 % CO₂ gas in a nitrogen base, and seawater samples (6) was programmed to repeat. The measurement of 2 % CO₂ gas was made to monitor response of coulometer solutions (from UIC, Inc.). For every renewal of coulometer solutions, certified reference materials (CRMs, batch 80 and a small number of batch 75) provided by Prof. A. G. Dickson of Scripps Institution of Oceanography were analyzed. In addition, in-house reference materials (RM) (batch: QRM Q15, Q16 and Q17) were measured at the initial, intermediate and end times of a coulometer solution's lifetime.

The preliminary values were reported in a data sheet on the ship. Repeatability and vertical profiles of C_T based on raw data for each station helped us check performances of the measuring systems.

In the cruise, we finished all the analyses for C_T on board the ship. As we used two systems, we had not encountered such a situation as we had to abandon the measurement due to time limitation.

(5) Quality control

We conducted quality control of the data after return to a laboratory on land. With calibration factors, which had been determined on board a ship based on blank and 5 kinds of Na₂CO₃ solutions, we calculated C_T of CRM (batches 80 and 75), and plotted the values as a function of sequential day,

separating legs and the systems used. There were no statistically-significant trends of CRM measurements.

Based on the averages of C_T of CRM, we re-calculated the calibration factors so that measurements of seawater samples become traceable to the certified value of batch 80. We did not use the measured results of batch 75 because of a small number of measurements.

Temporal variations of RM measurements for one coulometer solution are shown in Fig. 3.5.1. From this figure, it is evident that RM measurements had a linear trend of ~3 to ~7 μmol kg⁻¹, implying that measurements of seawater samples also have the trend. The trend was also found in temporal changes of 2 % CO₂ gas measurements. The trend seems to be due to “cell age” change (Johnson *et al.*, 1998) of a coulometer solution.

Considering the trends, we adjusted measurements of seawater samples so as to be traceable to the certified value (2006.50 μmol kg⁻¹) of batch 80.

Finally we surveyed vertical profiles of C_T. In particular, we examined whether systematic differences between measurements of the systems-A and -C existed or not. Then taking other information of analyses into account, we determined a flag of each value of C_T.

The average and standard deviation of absolute values of differences of C_T analyzed consecutively were 1.1 and 1.0 μmol kg⁻¹ (n=162), 1.2 and 1.1 μmol kg⁻¹ (n = 440) for MR07-04 and MR07-06, respectively.

To evaluate accuracy of measured C_T, we compared vertical profiles of C_T measured in MR07-04 and MR07-06 with those measured at a station of other WOCE lines crossing the P1 and P14 lines. Results are shown in Fig. 3.5.2. From these figures, it is found that C_T measured in the cruises is sufficiently accurate. Together with other comparisons, we estimated the accuracy to be ~ ± 2.0 μmol kg⁻¹.

Reference

Johnson, K. M., A. G. Dickson, G. Eiseid, C. Goyet, P. Guenther, R. M. Key, F. J. Millero, D. Purkerson, C. L. Sabine, R. G. Schottle, D. W. R. Wallace, R. J. Wilke and C. D. Winn (1998), Coulometric total carbon dioxide analysis for marine studies: assessment of the quality of total inorganic carbon measurements made during the US Indian Ocean CO₂ survey 1994-1996, Mar. Chem., 63, 21-37.

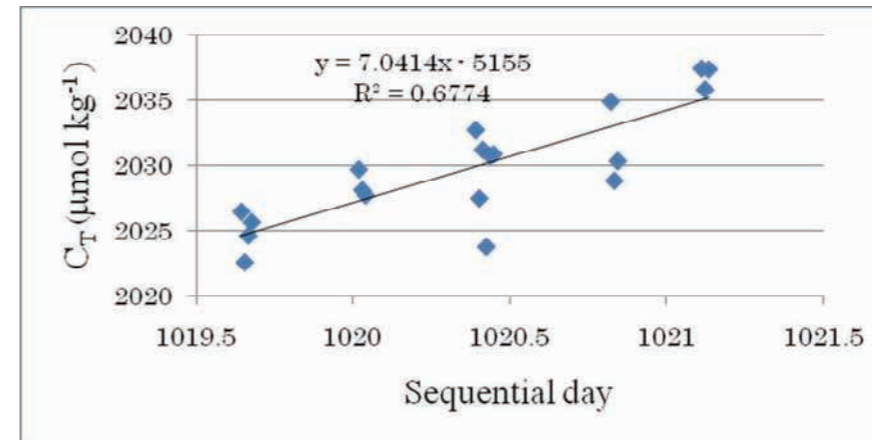
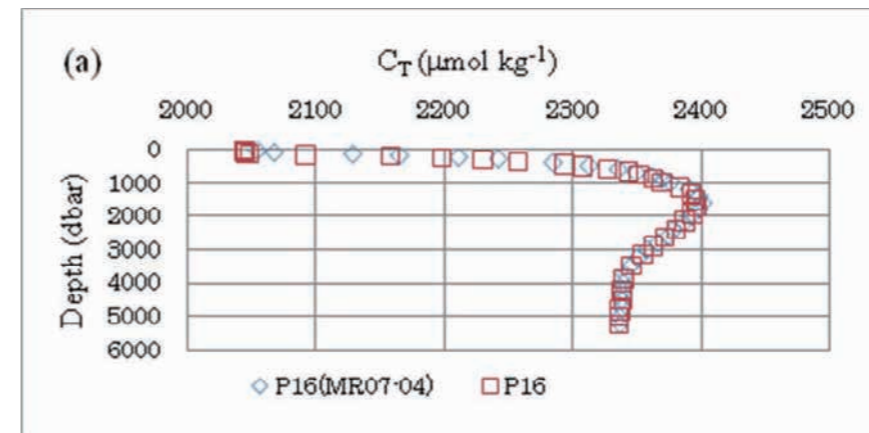

Fig. 3.5.1. Distributions of RM measurements as a function of sequential day for Stns. 044 and 046 during MR07-06.



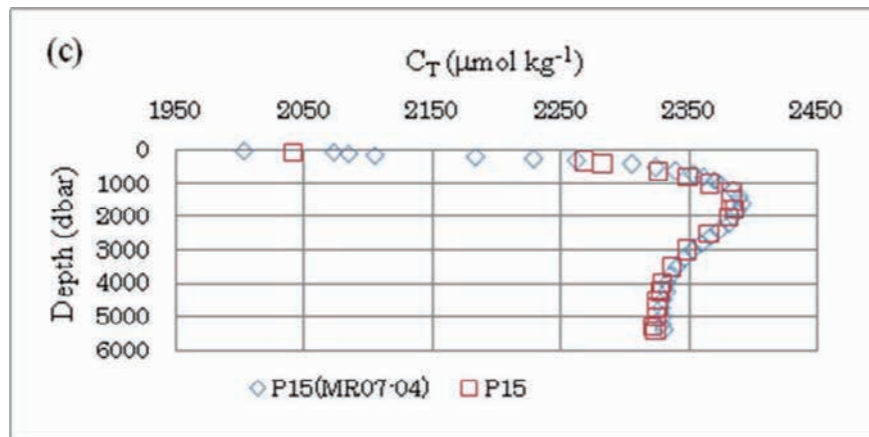
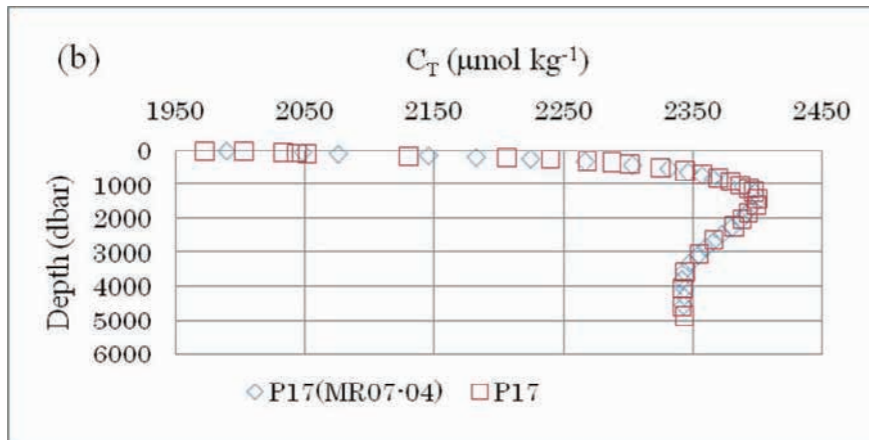

Fig. 3.5.2. Comparison of vertical profiles of C_T measured in MR07-04 with those measured previously at the cross points with (a) P16, (b) P17 and (c) P15 lines of WOCE.

3.6. Total alkalinity (A_T)

9 November 2008

(1) Personnel

Akihiko Murata (IORGC/JAMSTEC)

Minoru Kamata (MWJ)

Fuyuki Shibata (MWJ)

Aya Hatsuyama (MWJ)

(2) Objectives

Concentrations of CO_2 in the atmosphere are now increasing at a rate of 1.5 ppmv y^{-1} due to human activities such as burning of fossil fuels, deforestation, cement production, etc. It is an urgent task to estimate as accurately as possible the absorption capacity of the oceans against the increased atmospheric CO_2 , and to clarify the mechanism of the CO_2 absorption, because the magnitude of the predicted global warming depends on the levels of CO_2 in the atmosphere, and because the ocean currently absorbs 1/3 of the 6 Gt of carbon emitted into the atmosphere each year by human activities.

In the cruises (MR07-04 and MR07-06, revisit of WOCE P1 and P14 lines) using the R/V Mirai, we were aimed at quantifying how much anthropogenic CO_2 is absorbed in the Pacific Ocean. For the purpose, we measured CO_2 -system properties such as dissolved inorganic carbon (C_T), total alkalinity (A_T), pH and underway pCO_2 .

In this section, we describe data on A_T obtained in the cruise in detail.

(3) Apparatus

Measurement of A_T was made based on spectrophotometry using a custom-made system (Nippon ANS, Inc.). The system comprises of a water dispensing unit, an auto-burette (765 Dosimat, Metrohm), and a spectrophotometer (Carry 50 Bio, Varian), which are automatically controlled by a PC.

The water dispensing unit has a water-jacketed pipette and a water-jacketed titration cell. The spectrophotometer has a water-jacketed quartz cell, length and volume of which are 8 cm and 13 ml, respectively. To circulate sample seawater between the titration and the quartz cells, PFA tubes are connected to the cells.

A seawater of approx. 40 ml is transferred from a sample bottle (borosilicate glass bottle; 130 ml) into the water-jacketed (25 °C) pipette by pressurizing the sample bottle (nitrogen gas), and is introduced into the water-jacketed (25 °C) titration cell. The seawater is circulated between the titration and the quartz cells by a peristaltic pump to rinse the route. Then, Milli-Q water is introduced into the titration cell, and is circulated in the same route twice to rinse the route. Next, a seawater of approx. 40 ml is weighted again by the pipette, and is transferred into the titration cell. The weighted seawater is introduced into the quartz cell. Then, for seawater blank, absorbances are measured at three wavelengths (750, 616 and 444 nm). After the measurement, an acid titrant, which is a mixture of approx. 0.05 M HCl in 0.65 M NaCl and bromocresol green (BCG) is added (approx. 2.1 ml) into the titration cell. The seawater + acid titrant solution is circulated for 6 minutes between the titration and the quartz cells, with stirring by a stirring tip and bubbling by wet nitrogen gas in the titration cell. Then, absorbances at the three wavelengths are measured again.

Calculation of A_T was made by the following equation:

$$A_T = (-[\text{H}^+]_T V_{SA} + M_A V_A) / V_S,$$

where M_A is the molarity of the acid titrant added to the seawater sample, $[\text{H}^+]_T$ is the total excess hydrogen ion concentration in the seawater, and V_S , V_A and V_{SA} are the initial seawater volume, the added acid titrant volume, and the combined seawater plus acid titrant volume, respectively. $[\text{H}^+]_T$ is calculated from the measured absorbances based on the following equation (Yao and Byrne, 1998):

$$\text{pH}_T = -\log[\text{H}^+]_T = 4.2699 + 0.002578(35 - S) + \log((R - 0.00131)/(2.3148 - 0.1299R)) - \log(1 - 0.001005S),$$

where S is the sample salinity, and R is the absorbance ratio calculated as:

$$R = (A_{616} - A_{750}) / (A_{444} - A_{750}),$$

where A_i is the absorbance at wavelength i nm.

The HCl in the acid titrant was standardized (0.049977 M) on land. The concentrations of BCG were estimated to be approx. 0.04×10^{-3} M, and 2.0×10^{-6} M in the acid titrant and in the sample seawater, respectively.

(4) Shipboard measurement

(4.1) Sampling

All seawater samples were collected from depth using 12 liter Niskin bottles basically at every other stations. The seawater samples for A_T were taken with a plastic drawing tube (PFA tubing connected to silicone rubber tubing) into borosilicate glass bottles of 130 ml. The glass bottle was filled with seawater smoothly from the bottom after rinsing it with a seawater of half a or a full bottle volume. A few hours before analysis, the seawater samples were kept at 25 °C in a water bath.

(4.2) Analysis

We analyzed reference materials (RM; Batch: QRM 15, 16 and 17), which were produced for C_T measurement by JAMSTEC, but were efficient also for the monitor of A_T measurement. In addition, certified reference materials (CRM, batches 80 and 75, certified value = 2214.49 and 2210.09 $\mu\text{mol kg}^{-1}$,

respectively) were also analyzed periodically to monitor systematic differences of measured A_T . The reported values of A_T were set to be traceable to the certified value (2214.49 $\mu\text{mol kg}^{-1}$) of the batch 80.

The preliminary values were reported in a data sheet on the ship. Repeatability calculated from replicate samples and vertical profiles of A_T based on raw data for each station helped us check performance of the measuring system.

In the cruise, we finished all the analyses for A_T on board the ship. We did not encounter so serious problems as we had to give up the analyses.

(5) Quality control

Temporal changes of A_T were monitored by measuring A_T of CRM. We found no abnormal measurements during the cruises.

After making the measured values of A_T comparable to CRM, we examined vertical profiles of A_T . Then taking other information of analyses into account, we determined a flag of each value of A_T .

The average and standard deviation of absolute values of differences of A_T analyzed consecutively were 0.4 and 0.4 $\mu\text{mol kg}^{-1}$ ($n = 152$), and 0.5 and 0.5 $\mu\text{mol kg}^{-1}$ ($n = 407$) for MR07-04 and MR07-06, respectively.

To evaluate accuracy of measured A_T , we compared vertical profiles of A_T measured in MR07-04 and MR07-06 with those measured at a station of other WOCE lines crossing the P1 and P14 lines. Results are shown in Fig. 3.6.1. From these figures, it is found that A_T measured in the cruises are more accurate than those obtained in other WOCE lines, which were measured based on potentiometry. Together with other comparison, we estimated that the reported values were systematically 2.0 - 3.0 $\mu\text{mol kg}^{-1}$ higher than the previously reported values.

Reference

Yao W. and R. H. Byrne (1998) Simplified seawater alkalinity analysis: Use of linear array spectrometers. Deep-Sea Research I 45, 1383-1392.

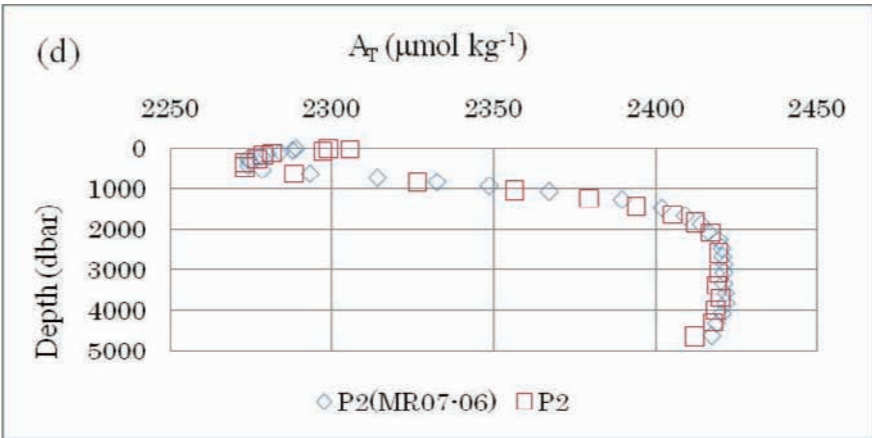
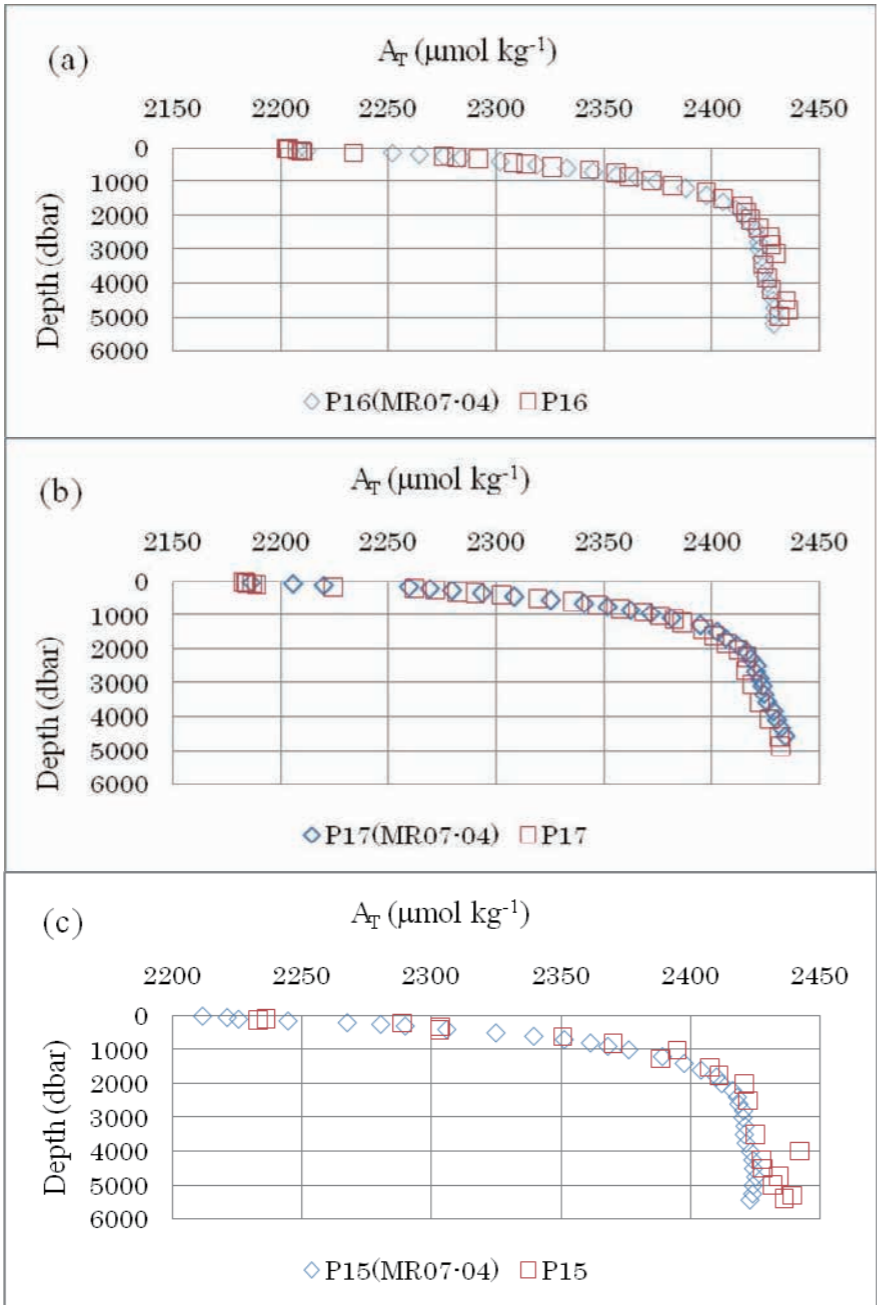

Fig. 3.6.1. Comparison of vertical profiles of A_T measured in MR07-04 and MR07-06 with those measured previously at the cross points with (a) P16, (b) P17 (c) P15, and (d) P2 lines of WOCE.

3.7. pH

9 November 2008

(1) Personnel

Akihiko Murata (IORGC, JAMSTEC)

Fuyuki Shibata (MWJ)

Aya Hatsuyama (MWJ)

(2) Objectives

Concentrations of CO₂ in the atmosphere are now increasing at a rate of 1.5 ppmv y⁻¹ due to human activities such as burning of fossil fuels, deforestation, cement production, etc. It is an urgent task to estimate as accurately as possible the absorption capacity of the oceans against the increased atmospheric CO₂, and to clarify the mechanism of the CO₂ absorption, because the magnitude of the anticipated global warming depends on the levels of CO₂ in the atmosphere, and because the ocean currently absorbs 1/3 of the 6 Gt of carbon emitted into the atmosphere each year by human activities.

In the cruises (MR07-04 and MR07-06, revisit of WOCE P1 and P14 lines) using the R/V Mirai, we were aimed at quantifying how much anthropogenic CO₂ is absorbed in the Pacific Ocean. For the purpose, we measured CO₂-system properties such as dissolved inorganic carbon (C_T), total alkalinity (A_T), pH and underway pCO₂.

In this section, we describe data on pH obtained in the cruise in detail.

(3) Apparatus

Measurement of pH was made by a pH measuring system (Nippon ANS, Inc.), which adopts spectrophotometry. The system comprises of a water dispensing unit and a spectrophotometer (Carry 50 Scan, Varian).

Seawater is transferred from borosilicate glass bottle (300 ml) to a sample cell in the

spectrophotometer. The length and volume of the cell are 8 cm and 13 ml, respectively, and the sample cell was kept at 25.00 ± 0.05 °C in a thermostated compartment. First, absorbances of seawater only are measured at three wavelengths (730, 578 and 434 nm). Then an indicator is injected and circulated for about 4 minutes, to mix the indicator and seawater sufficiently. After the pump is stopped, the absorbances of seawater + indicator are measured at the same wavelengths.

The pH is calculated based on the following equation (Clayton and Byrne, 1993):

$$pH = pK_2 + \log\left(\frac{A_1 / A_2 - 0.00691}{2.2220 - 0.1331(A_1 / A_2)}\right) \quad (1),$$

where A₁ and A₂ indicate absorbances at 578 and 434 nm, respectively, and pK₂ is calculated as a function of water temperature and salinity.

(4) Shipboard measurement

(4.1) Sampling

All seawater samples were collected from depth with 12 liter Niskin bottles basically at every other stations. The seawater samples for pH were taken with a plastic drawing tube (PFA tubing connected to silicone rubber tubing) into a 300 ml borosilicate glass bottle, which was the same as used for C_T sampling. The glass bottle was filled with seawater smoothly from the bottom following a rinse with a sea water of 2 full, bottle volumes. The glass bottle was closed by a stopper, which was fitted to the bottle mouth gravimetrically without additional force.

A few hours just before analysis, the seawater samples were kept at 25 °C in a water bath.

(4.2) Analysis

For an indicator solution, *m*-cresol purple (2 mM) was used. The indicator solution was produced on board a ship, and retained in a 1000 ml DURAN® laboratory bottle. We renewed an

indicator solution 3 times when the headspace of the bottle became large, and monitored pH or absorbance ratio of the indicator solution by another spectrophotometer (Carry 50 Scan, Varian) using a cell with a short path length of 0.5 mm. In most indicator solutions, the absorbance ratios of the indicator solution were initially in the range 1.4 – 1.6, and decreased to 1.1.

It is difficult to mix seawater with an indicator solution sufficiently under no headspace condition. However, by circulating the mixed solution with a peristaltic pump, a well-mixed condition came to be attained rather shortly, leading to a rapid stabilization of absorbance. We renewed a TYGON® tube of a peristaltic pump periodically, when a tube deteriorated.

Absorbances of seawater only and seawater + indicator solutions were measured 15 times each, and averages computed from the last five values of absorbance were used for the calculation of pH (Eq. 1).

The preliminary values of pH were reported in a data sheet on the ship. Repeatability calculated from replicate samples and vertical profiles of pH based on raw data for each station helped us check performance of the measuring system.

We finished all the analyses for pH on board the ship. We did not encounter so serious a problem as we had to give up the analyses. However, we sometimes experienced malfunctions of the system during the cruise:

Differences between absorbances of seawater only and those of seawater + indicator solution were infrequently greater than ± 0.001 . This implies dirt of the cell. In this case, we cleaned or replaced the cell.

(5) Quality control

It is recommended that correction for pH change resulting from addition of indicator solutions is made (DOE, 1994). To check the perturbation of pH due to the addition, we measured absorbance ratios by doubling the volume of indicator solutions added to a same seawater sample. We corrected absorbance ratios based on an empirical method (DOE, 1994), although the perturbations were small. Figure 3.7.1 illustrates an example of perturbation of absorbance ratios by adding indicator solutions.

We surveyed vertical profiles of pH. In particular, we examined whether systematic differences

between before and after the renewal of indicator solutions existed or not. Then taking other information of analyses into account, we determined a flag of each value of pH.

The average and standard deviation of absolute values of differences of pH analyzed consecutively were 0.0008 and 0.0007 pH unit ($n = 199$), and 0.0005 and 0.0006 pH unit ($n = 565$) for MR07-04 and MR07-06, respectively.

References

- Clayton T.D. & R.H. Byrne (1993) Spectrophotometric seawater pH measurements: total hydrogen ion concentration scale calibration of m-cresol purple and at-sea results. *Deep-Sea Research* 40, 2115-2129.
- DOE (1994) Handbook of methods for the analysis of the various parameters of the carbon dioxide system in sea water, version 2, A. G. Dickson & C. Goyet, eds. (unpublished manuscript).

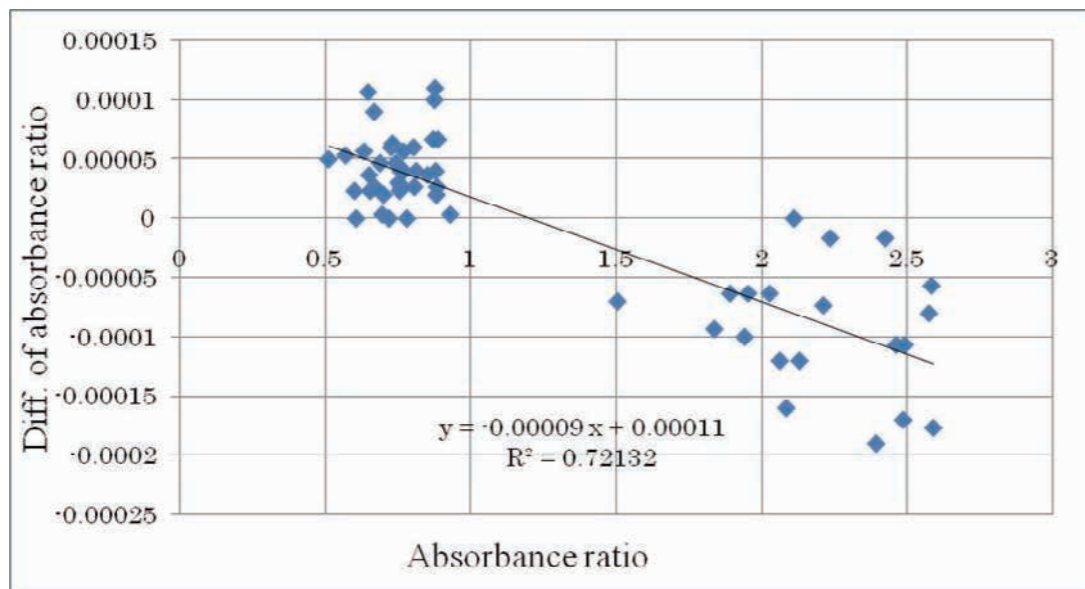

Figure 3.7.1. Perturbation of absorbance ratios by adding indicator solutions. The line ($y = -0.00009x + 0.00011$, $R^2 = 0.72132$) was determined by the method of least squares.

3.8 Chlorofluorocarbons (CFCs)

3 November 2008

(1) Personnel

Ken'ichi Sasaki (MIO, JAMSTEC)

Masahide Wakita (MIO, JAMSTEC)

Katsunori Sagishima (MWJ)

Yuichi Sonoyama (MWJ)

Shoko Tatamisashi (MWJ)

(2) Introduction

Chlorofluorocarbons (CFCs) are completely man-made compounds that are chemically and biologically stable gasses in the environment. The CFCs have accumulated in the atmosphere since 1930's (Walker et al., 2000) and the atmospheric CFCs can slightly dissolve in sea surface water. The dissolved CFCs concentrations in sea surface water should have changed year by year and then penetrate into the ocean interior by water circulation. Three chemical species of CFCs, namely CFC-11 (CCl_3F), CFC-12 (CCl_2F_2) and CFC-113 ($\text{C}_2\text{Cl}_3\text{F}_3$), dissolved in seawater are useful transient tracers for the ocean circulation with timescale on the order of decades. In these cruises, we determined concentrations of CFCs dissolved in seawater on board.

Carbon tetrachloride (CCl_4), CFC like compound, have been used as an additional chemical tracer which have longer history than CFCs. This compound was also been analyzed for several stations as qualitative indicator.

(3) Apparatus

Dissolved CFCs and CCl_4 were measured by a typical method modified from the original design of Bullister and Weiss (1988). A custom made purging and trapping system was attached to gas

chromatograph (GC-14B: Shimadzu Ltd) having an electron capture detector (ECD-14: Shimadzu Ltd). Cold trap columns were stainless steel tube packed with 80/100 mesh Porapak T in MR07-04 cruise and with 80/100 mesh Porapak N in MR07-06 cruise. A pre-column and a main column on CFCs system were Silica Plot capillary column [i.d.: 0.53mm, length: 8m, film thickness: 6 μm] and a complex capillary column (Pola Bond-Q [i.d.: 0.53mm, length: 7m, film thickness: 10 μm] followed by Silica Plot [i.d.: 0.53mm, length: 22m, film thickness: 6 μm]), respectively. On the CCl_4 system, these were DB-624 capillary column [i.d.: 0.53 mm, length: 30 m, film thickness: 3 μm] and longer DB-624 capillary column [length: 100 m], respectively.

(4) Shipboard measurement

(4.1) Sampling

Before casting CTD, the water sampling system was cleaned by diluted acetone to remove any oils which could cause contaminations of CFCs. Seawater sub-samples were collected from 12 liter Niskin bottles into glass bottles. The bottle volumes were 300ml and 150ml for CFCs and CCl_4 analyses, respectively. The bottles had been filled with pure nitrogen gas before the sampling. The two times bottle volumes of seawater sample were overflowed. The bottles filled with seawater were kept in water bathes roughly controlled on the sample temperature. The concentrations were determined as soon as possible (normally within 12 hrs).

(4.2) Analysis

Constant volume of sample water (50ml for CFCs and 30 ml for CCl_4) was taken into the purging & trapping system. Dissolved CFCs and CCl_4 were extracted by nitrogen gas purge. The sample gas were dried by magnesium perchlorate desiccant and concentrated on a trap column cooled to -45 °C. The compounds were desorbed by electrically heating the trap column to 140 °C for CFCs and to 130 °C for CCl_4 within 1.5 minutes, and led into the pre-column. The gasses were roughly separated on the pre-column. When required compounds were eluted, the pre-column was switched onto cleaning line

and flushed back by counter flow of pure nitrogen gas. The back flush system prevented to enter any compounds that had higher retention time than CFCs and CCl₄ into main analytical column and permitted short time analysis. The compounds which were sent onto main column were separated further and detected by an electron capture detector (ECD). On the CFCs analytical system, retention time of compounds was around 1.5, 4.4 and 11 minutes for CFC-12, -11 and -113, respectively. On the CCl₄ system, that was 6 min, 8min, 10 min and 15 min for CFC-12, -11, -113, and CCl₄. Temperatures of an analytical column and a detector were 95 and 240 °C for CFC analysis, respectively. These were 50 and 200 °C for CCl₄ analysis, respectively. Pure nitrogen gas (99.99995) was purified by a molecular sieve 13X gas filter and was used for analyses. On the CFCs system, mass flow rates of nitrogen gas were 17, 20, 20 and 200 ml/min for carrier, detector make up, back flush and sample purging gasses, respectively. On the CCl₄ system, these were 13, 27, 20 and 130 ml/min, respectively.

Gas loops whose volumes were around 1, 3 and 10 ml were used for introducing standard gases into the analytical system. The standard gasses had been made by Japan Fine Products co. ltd. Standard gas cylinder numbers used in cruises were listed in Table 3-8-1. Cylinder of CPB30524 was for reference.

Precise mixing ratios of the standard gasses were calculated by gravimetric data. The standard gases

Table 3-8-1. Standard gas cylinder list.

Cylinder No.	Concentration determined gravimetric data (pptv).			
	CFC-11	CFC-12	CFC-113	CCl ₄
CPB02957	300	159	30.0	249
CPB03033	302	162	30.8	0
CPB03322	301	161	30.6	399
CPB09898	301	161	30.6	400
CPB28489	300	160	30.0	250
CPB30524	300	159	30.2	403

used in this cruise have not been calibrated to SIO scale standard gases yet because SIO scale standard gasses is hard to obtain due to legal difficulties for CFCs import into Japan. The data will be corrected as soon as possible when we obtain the standard gasses.

(5) Quality control

(5.1) Main problems on the shipboard analysis

CFC-12

CFC-12 data observed from Station P01-010 and P01-011 (MR07-04) may contain large err. At the analyses, there was trouble of air conditioner of analytical room and room temperature remarkably rose up to 37 °C. Capacity of cooling system of cold trap felled off and a part of CFC-12 was not quantitatively absorbed on the trap. Although the concentrations were corrected by the trapping efficiency estimated from standard gas analyses, we give this data flag “3”.

CFC-113

A large and broad peak was interfered determining CFC-113 peak area for samples collected from surface several hundred meters depth in the latitude band of subtropical and tropical region (MR07-06). Retention time of the interfering peak was around 3 % shorter than that of CFC-113. The peak of a compound interfering CFC-113 determination could not be completely separated from the peak of CFC-113 by our analytical condition. We tried to split these peaks on chromatogram analysis and give flag “4”. In the case of the interfering peak completely covering the CFC-113 peak, we could not determine CFC-113 peak area and give flag “5”.

CCl₄

Several problems were found in CCl₄ analysis as follows, and all CCl₄ data were given flag “4”. One of the problems was in standardization. Mixing ratio of the atmospheric CCl₄ observed in these cruises was notably higher than the annual mean value reported by Dr. J. L. Bullister in web site of Carbon Dioxide Information Analysis Center (CDIAC, http://cdiac.ornl.gov/oceans/new_atmCFC.html). Concentration

of CCl₄ in surface water was also higher than predicted value from the solubility (Bullister and Wisegarver, 1998). Concentration of CCl₄ was corrected by using the reported atmospheric CCl₄ mixing ratio and concentration of CCl₄ was corrected but accuracy was doubtful. Additional problem was high blank. The gas line blank was negligible but water line blank was high and varied from 0.04 to 0.07 pmol/kg. These blank values were too high to determine precise concentration of CCl₄ though the blank value was frequently obtained and corrected.

(5.2) Blank of CFC-11 and CFC-12

Some blank water samples which were made by nitrogen purge of seawater in CFCs sample bottle were analyzed and any CFCs were not detected. Significant increase in CFCs concentration during keeping sampling bottle in a water bath was not found for around one week. CFCs concentrations in deep water which was one of oldest water masses in the ocean were low but not zero for CFC-11 and -12. Average concentrations of CFC-11, 12 in the deep water denser than 27.7 σ_{θ} and warmer than 1°C of potential temperature were 0.012 ± 0.005 , 0.006 ± 0.003 pmol kg⁻¹(n > 1500), respectively. These values were assumed as sampling blanks which was contaminations from Niskin bottle and/or during sub-sampling and were subtracted from all data. Significant blank was not found in CFC-113 measurements.

(5.3) Precisions

The analytical precisions were estimated from replicate sample analyses (Table 3-8-2). The replicate samples were basically collected from two sampling depths which is around 150 m and 700 m depths.

Table. 3-8-2. Analytical precisions of CFC concentrations estimated from replicate analyses.

Cruise	CFCs	Precisions*		n
		(pmol kg ⁻¹)	(%)	
MR07-04				
	CFC-11	0.009	0.4	154
	CFC-12	0.007	0.6	151
	CFC-113	0.008	7	158
MR07-06 Leg 1				
	CFC-11	0.010	0.6	233
	CFC-12	0.008	0.9	234
	CFC-113	0.008	10	217
MR07-06 Leg 2				
	CFC-11	0.007	0.6	206
	CFC-12	0.009	0.8	206
	CFC-113	0.004	5	112

*Precision whichever is greater

(6) References

- Walker, S.J., Weiss, R.F. and Salameh, P.K., Reconstructed histories of the annual mean atmospheric mole fractions for the halocarbons CFC-11, CFC-12, CFC-113 and Carbon Tetrachloride, *Journal of Geophysical Research*, **105**, 14,285-14,296, (2000).
- Bullister, J.L and Weiss, R.F. Determination of CCl₃F and CCl₂F₂ in seawater and air. *Deep Sea Research*, **35**, 839-853 (1988).

3.9 Lowered Acoustic Doppler Current Profiler

5 November 2008

(1) Personnel

Shinya Kouketsu (JAMSTEC)

Hiroshi Uchida (JAMSTEC)

Yoshimi Kawai (JAMSTEC)

Katsuro Katsumata (JAMSTEC)

Toshimasa Doi (JAMSTEC)

(2) Overview of the equipment

An acoustic Doppler current profiler (ADCP) was integrated with the CTD/RMS package. The lowered ADCP (LADCP), Workhorse Monitor WHM300 (Teledyne RD Instruments, San Diego, California, USA), which has 4 downward facing transducers with 20-degree beam angles, rated to 6000 m. The LADCP makes direct current measurements at the depth of the CTD, thus providing a full profile of velocity. The LADCP was powered during the CTD casts by a 50.4 volts rechargeable Ni-Cd battery pack. The LADCP unit was set for recording internally prior to each cast. After each cast the internally stored observed data was uploaded to the computer on-board. By combining the measured velocity of the sea water and bottom with respect to the instrument, and shipboard navigation data during the CTD cast, the absolute velocity profile can be obtained (e.g. Visbeck, 2002).

The instrument used in this cruise was as follows.

Teledyne RD Instruments, WHM300-I-UG27

S/N 8484 (CPU firmware ver. 16.28)

S/N 2553 (CPU firmware ver. 16.28) (with pressure sensor) *

* Serial number 2553 was used at stations from P14C_41 to P14C_32.

(3) Data collection

In this cruise, data were collected with the following configuration.

Bin size: 8.0 m

Number of bins: 14

Pings per ensemble: 1

Ping interval: 1.0 sec

At the following stations, the CTD cast was carried out without the LADCP, because the maximum pressure was beyond the pressure-proof of the LADCP (6000 m).

Stations from P01_11 to P01_12

Stations from P01_44 to P01_46

Stations from P01_53 to P01_54

Stations from P14N_24 to P14N_23

(4) Data collection problems

Echo intensity of a transducer of serial number 8484 was found to become weak gradually, which is shown in the echo intensity means in each cast at the second (Fig. 3.8.1). The peak after station P14N_140 results from enhanced reflections by the equatorial upwelling and that after P14C-52 from the substitution by another sensor (serial number 2553). A part of data from the substituted sensor was missed by unknown reason at the following stations.

P14C_40: from 2920 m of down-cast to 2870 m of up-cast

P14C_33: from 2440 m of down-cast to 2680 m of up-cast

P14C_32: from 3540 m of down-cast to 3330 m of up-cast

Therefore the original sensor (serial number 8484) was used again after 10 casts from the substitution.

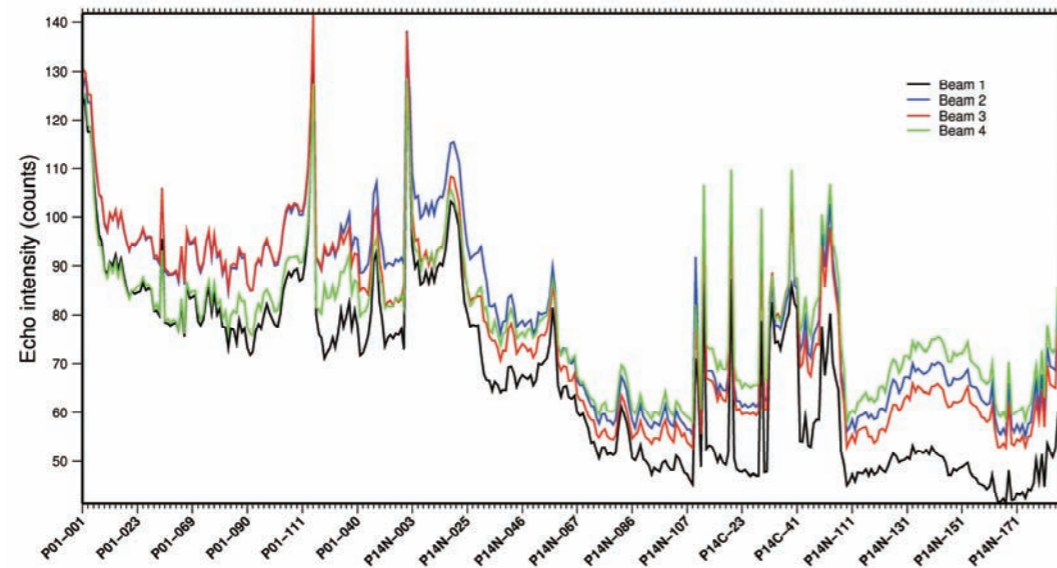

Fig. 3.9.1. Cast-averaged echo intensity at the second bin in each beam of the LADCP for MR07-04 and MR07-06 cruises.

(4) Data process

Vertical profiles of velocity are obtained by the inversion method (Visbeck, 2002). Since the first bin from LADCP is influenced by the turbulence generated by CTD frame, the weight for the inversion is set to small value of 0.1. GPS navigation data are used in the calculation of the reference velocities and the bottom-track data are used for the correction of reference velocities. Shipboard ADCP (SADCP) data averaged for 1 minute are also included in the calculation. The CTD data are used for the sound speed and depth calculation. IGRF (International Geomagnetic Reference Field) 10th

generation data are used for calculating magnetic deviation to correct the direction of velocity. In the processing, we use Matlab routines provided from M. Visbeck and G. Krahnemann (<http://ladcp.ldeo.columbia.edu/ladcp>).

Reference

Visbeck, M. (2002): Deep velocity profiling using Lowered Acoustic Doppler Current Profilers: Bottom track and inverse solutions. *J. Atmos. Oceanic Technol.*, 19, 794-807.

49MR0704_1.sum file

P01 REV R/V MIRAI CRUISE MR0704

SHIP/CRS	WOCE	CAST		UTC EVENT		POSITION			UNC	COR HT ABOVE	WIRE	MAX	NO. OF			COMMENTS		
EXPCODE	SECT	STNNBR	CASTNO	TYPE	DATE	TIME	CODE	LATITUDE	LONGITUDE	NAV	DEPTH	DEPTH	BOTTOM	OUT	PRESS	BOTTLES	PARAMETERS	
49MR0704_1	P01	1	1	ROS	072607	0905	BE	42 58.28 N	145 27.30 E	GPS	101	99						
49MR0704_1	P01	1	1	BUC	072607	0906	UN	42 58.28 N	145 27.29 E	GPS	102	99					1,31,33,34,82	11.3C
49MR0704_1	P01	1	1	ROS	072607	0910	BO	42 58.29 N	145 27.26 E	GPS	102	99	10	85	89	6	1-8,23,24,26,27,31,33,34,37,81,82	#2 CHLOR MAX, SOME SMPLS WERE TAKEN FROM DUPL BTLS
49MR0704_1	P01	1	1	ROS	072607	0918	EN	42 58.30 N	145 27.26 E	GPS	102	99						
49MR0704_1	P01	1	1	UNK	072607	0928	UN	42 58.21 N	145 27.46 E	GPS	103	99						AIR CH4/N2O AND COS SMPL
49MR0704_1	P01	2	1	ROS	072607	1109	BE	42 53.36 N	145 31.20 E	GPS	358	356						
49MR0704_1	P01	2	1	BUC	072607	1112	UN	42 53.35 N	145 31.17 E	GPS	357	355					1	10.8C
49MR0704_1	P01	2	1	ROS	072607	1120	BO	42 53.36 N	145 31.10 E	GPS	357	354	9	350	353	7	1-8,23,24,26,27	
49MR0704_1	P01	2	1	ROS	072607	1137	EN	42 53.35 N	145 30.98 E	GPS	355	353						
49MR0704_1	P01	3	1	ROS	072607	1315	BE	42 51.36 N	145 32.54 E	GPS	958	960						
49MR0704_1	P01	3	1	BUC	072607	1323	UN	42 51.34 N	145 32.50 E	GPS	943	944					1	11.2C
49MR0704_1	P01	3	1	ROS	072607	1336	BO	42 51.31 N	145 32.45 E	GPS	923	926	12	909	916	14	1-8,23,24,26,27	
49MR0704_1	P01	3	1	ROS	072607	1419	EN	42 51.23 N	145 32.21 E	GPS	958	957						
49MR0704_1		401	1	UNK	072607	1444	BE	42 50.94 N	145 32.54 E	GPS	1029	1029						FOG WATER SMPL FOR TRACE ELEMENTS (#21)
49MR0704_1	P01	4	1	ROS	072607	1601	BE	42 48.81 N	145 35.61 E	GPS	1534	1534						THICK FOG
49MR0704_1	P01	4	1	BUC	072607	1608	UN	42 48.80 N	145 35.54 E	GPS	1525	1529					1	11.0C
49MR0704_1	P01	4	1	ROS	072607	1633	BO	42 48.85 N	145 35.38 E	GPS	1536	1534	10	1556	1566	17	1-8,27,37	
49MR0704_1	P01	4	1	ROS	072607	1729	EN	42 48.84 N	145 34.68 E	GPS	1516	1517						
49MR0704_1	P01	5	1	ROS	072607	1848	BE	42 38.88 N	145 41.92 E	GPS	2388	2390						THICK FOG
49MR0704_1	P01	5	1	BUC	072607	1856	UN	42 38.80 N	145 41.87 E	GPS	2409	2408					1	11.4C
49MR0704_1		401	1	UNK	072607	1856	EN	42 38.81 N	145 41.87 E	GPS	2408	2408						
49MR0704_1		402	1	UNK	072607	1856	BE	42 38.81 N	145 41.87 E	GPS	2408	2408						FOG WATER SMPL FOR TRACE ELEMENTS (#22)
49MR0704_1	P01	5	1	ROS	072607	1930	BO	42 38.64 N	145 41.56 E	GPS	2412	2411	14	2442	2441	21	1-8,23,24,26,27	
49MR0704_1	P01	5	1	ROS	072607	2042	EN	42 38.11 N	145 41.13 E	GPS	2354	2358						
49MR0704_1	P01	6	1	ROS	072607	2221	BE	42 29.59 N	145 50.41 E	GPS	3149	3149						THICK FOG
49MR0704_1	P01	6	1	BUC	072607	2229	UN	42 29.56 N	145 50.36 E	GPS	3150	3150					1	11.9C
49MR0704_1	P01	6	1	UNK	072607	2232	UN	42 29.54 N	145 50.36 E	GPS	3148	3148						80L THROUGH HULL PUMP FOR R.N.
49MR0704_1	P01	6	1	ROS	072607	2315	BO	42 29.37 N	145 50.19 E	GPS	3146	3144	10	3150	3182	33	1-8,22,27	
49MR0704_1		402	1	UNK	072607	2340	EN	42 29.31 N	145 50.12 E	GPS	3146	3146						
49MR0704_1	P01	6	1	ROS	072707	0044	EN	42 29.03 N	145 49.78 E	GPS	3148	3149						
49MR0704_1	P01	7	1	ROS	072707	0218	BE	42 17.11 N	146 3.27 E	GPS	4166	4166						THICK FOG
49MR0704_1	P01	7	1	BUC	072707	0229	UN	42 17.05 N	146 3.23 E	GPS	4171	4171					1	13.4C
49MR0704_1	P01	7	1	ROS	072707	0325	BO	42 17.08 N	146 3.20 E	GPS	4160	4158	13	4171	4228	29	1-8,23,24,26,27	
49MR0704_1	P01	7	1	ROS	072707	0519	EN	42 16.93 N	146 2.97 E	GPS	4169	4166						
49MR0704_1		403	1	UNK	072707	0600	BE	42 14.12 N	146 3.90 E	GPS	4504	4504						FOG WATER SMPL FOR TRACE ELEMENTS (#23)
49MR0704_1	P01	8	1	ROS	072707	0658	BE	42 10.79 N	146 5.03 E	GPS	5055	5050						FOG
49MR0704_1		403	1	UNK	072707	0700	EN	42 10.79 N	146 5.05 E	GPS	5047	5047						
49MR0704_1	P01	8	1	BUC	072707	0705	UN	42 10.79 N	146 5.04 E	GPS	5054	5054					1,31,33	13.7C
49MR0704_1	P01	8	1	ROS	072707	0814	BO	42 10.82 N	146 5.18 E	GPS	5033	5036	11	5060	5134	33	1-8,23,24,26,27,31,33	
49MR0704_1	P01	8	1	ROS	072707	1017	EN	42 10.97 N	146 5.84 E	GPS	5057	5058						
49MR0704_1	P01	9	1	ROS	072707	1230	BE	41 59.11 N	146 13.56 E	GPS	6160	6160						WITHOUT FLUOROMETER, FOG
49MR0704_1	P01	9	1	BUC	072707	1238	UN	41 59.11 N	146 13.64 E	GPS	6162	6162					1	13.4C
49MR0704_1	P01	9	1	ROS	072707	1404	BO	41 58.95 N	146 14.55 E	GPS	6256	6255	11	6240	6282	36	1-8,27,37	
49MR0704_1	P01	9	1	ROS	072707	1659	EN	41 58.56 N	146 16.46 E	GPS	6139	6139						
49MR0704_1		404	1	UNK	072707	1721	BE	41 58.12 N	146 16.38 E	GPS	6177	6177						FOG WATER SMPL FOR TRACE ELEMENTS (#24)

49MR0704_1	P01	19	1	ROS 073007 0111	BO 39 56.92 N 147 42.81 E GPS	5237	5238	10	5260	5314	34	1-8,12,13,23,24,26,27	
49MR0704_1	P01	19	1	ROS 073007 0337	EN 39 57.75 N 147 42.56 E GPS	5239	5240						
49MR0704_1	P01	20	1	ROS 073007 0531	BE 39 41.32 N 147 55.63 E GPS	5359	5358						
49MR0704_1	P01	20	1	BUC 073007 0539	UN 39 41.36 N 147 55.51 E GPS	5355	5354					1,83	20.7C
49MR0704_1	P01	20	1	ROS 073007 0655	BO 39 41.67 N 147 55.26 E GPS	5353	5351	10	5380	5442	34	1-8,27,37	
49MR0704_1	P01	20	1	ROS 073007 0904	EN 39 42.17 N 147 54.54 E GPS	5346	5345						
49MR0704_1	P01	21	1	ROS 073007 1124	BE 40 1.06 N 148 24.64 E GPS	5475	5476						
49MR0704_1	P01	21	1	BUC 073007 1131	UN 40 1.06 N 148 24.50 E GPS	5467	5468					1,31,33,34,82	21.1C
49MR0704_1	P01	21	1	ROS 073007 1249	BO 40 1.31 N 148 24.18 E GPS	5459	5461	10	5484	5559	36	1-8,23,24,26,27,31,33,34,64,81,82	#2 AT CHLOR MAX RAIN SMPL FOR STABLE ISOTOPE (#2, 0.8MM)
49MR0704_1		409	1	UNK 073007 1312	UN 40 1.35 N 148 24.15 E GPS	5461	5461						
49MR0704_1	P01	21	1	ROS 073007 1510	EN 40 1.56 N 148 23.66 E GPS	5452	5453						
49MR0704_1	P01	21	1	UNK 073007 1524	UN 40 2.06 N 148 24.50 E GPS	5461	5459						AIR CH4/N2O SMPL
49MR0704_1		410	1	UNK 073007 1524	BE 40 2.11 N 148 24.60 E GPS	5458	5459						FOG WATER SMPL FOR TRACE ELEMENTS (#28)
49MR0704_1	P01	22	1	ROS 073007 1732	BE 40 19.23 N 148 52.67 E GPS	5468	5468						FOG
49MR0704_1	P01	22	1	BUC 073007 1742	UN 40 19.21 N 148 52.62 E GPS	5468	5468					1	20.5C
49MR0704_1	P01	22	1	UNK 073007 1746	UN 40 19.20 N 148 52.60 E GPS	5467	5467						95L THROUGH HULL PUMP FOR R.N.
49MR0704_1		410	1	UNK 073007 1820	EN 40 19.18 N 148 52.40 E GPS	5466	5466						
49MR0704_1	P01	22	1	ROS 073007 1857	BO 40 19.28 N 148 52.30 E GPS	5465	5465	7	5475	5561	36	1-8,22,27	
49MR0704_1		411	1	UNK 073007 2055	UN 40 19.59 N 148 51.83 E GPS	5468	5468						RAIN SMPL FOR STABLE ISOTOPE (#3, 0.3MM)
49MR0704_1	P01	22	1	ROS 073007 2109	EN 40 19.62 N 148 51.79 E GPS	5467	5468						
49MR0704_1	P01	22	2	UNK 073007 2130	UN 40 21.03 N 148 54.26 E GPS	5489	5489						AIR COS SMPL
49MR0704_1		412	1	UNK 073007 2204	BE 40 24.77 N 149 0.79 E GPS	5507	5507						FOG WATER SMPL FOR TRACE ELEMENTS (#29)
49MR0704_1		412	1	UNK 073007 2300	EN 40 30.74 N 149 11.08 E GPS	5269	5267						
49MR0704_1	P01	23	1	ROS 073107 0023	BE 40 37.28 N 149 22.48 E GPS	5356	5354						
49MR0704_1	P01	23	1	BUC 073107 0030	UN 40 37.33 N 149 22.57 E GPS	5351	5349					1	21.3C
49MR0704_1	P01	23	1	ROS 073107 0144	BO 40 37.41 N 149 22.77 E GPS	5351	5349	9	5362	5450	33	1-8,23,24,26,27	#15 MISS FIRE
49MR0704_1	P01	23	1	ROS 073107 0401	EN 40 37.55 N 149 23.21 E GPS	5348	5346						
49MR0704_1	P01	24	1	ROS 073107 0714	BE 40 55.49 N 149 51.06 E GPS	5390	5388						
49MR0704_1	P01	24	1	BUC 073107 0721	UN 40 55.55 N 149 51.17 E GPS	5386	5386					1,83	21.4C
49MR0704_1	P01	24	1	ROS 073107 0836	BO 40 55.67 N 149 51.73 E GPS	5382	5380	9	5410	5476	35	1-8,27,37	
49MR0704_1	P01	24	1	ROS 073107 1047	EN 40 55.75 N 149 53.14 E GPS	5370	5369						
49MR0704_1		413	1	UNK 073107 1124	BE 41 1.31 N 150 1.00 E GPS	5232	5231						FOG WATER SMPL FOR TRACE ELEMENTS (#30)
49MR0704_1		413	1	UNK 073107 1240	EN 41 15.21 N 150 19.63 E GPS	5356	5353						
49MR0704_1	P01	25	1	ROS 073107 1255	BE 41 15.83 N 150 20.61 E GPS	5370	5366						
49MR0704_1	P01	25	1	BUC 073107 1303	UN 41 15.90 N 150 20.82 E GPS	5371	5367					1,31,33	19.6C
49MR0704_1	P01	25	1	ROS 073107 1418	BO 41 15.68 N 150 21.42 E GPS	5376	5373	9	5381	5468	34	1-8,23,24,26,27,31,33	
49MR0704_1	P01	25	1	ROS 073107 1634	EN 41 15.10 N 150 22.59 E GPS	5373	5369						
49MR0704_1	P01	26	1	ROS 073107 1853	BE 41 33.70 N 150 52.27 E GPS	5213	5211						
49MR0704_1	P01	26	1	BUC 073107 1900	UN 41 33.68 N 150 52.30 E GPS	5212	5211					1	16.6C
49MR0704_1	P01	26	1	UNK 073107 1902	UN 41 33.68 N 150 52.33 E GPS	5214	5213						95L THROUGH HULL PUMP FOR R.N.
49MR0704_1	P01	26	1	ROS 073107 2011	BO 41 33.73 N 150 52.43 E GPS	5212	5211	8	5219	5303	36	1-8,22,27	
49MR0704_1	P01	26	1	ROS 073107 2215	EN 41 33.76 N 150 52.72 E GPS	5209	5208						
49MR0704_1	P01	27	1	ROS 080107 0048	BE 41 56.44 N 151 27.78 E GPS	5152	5154						
49MR0704_1	P01	27	1	BUC 080107 0055	UN 41 56.45 N 151 27.85 E GPS	5151	5153					1	16.9C
49MR0704_1	P01	27	1	ROS 080107 0208	BO 41 56.41 N 151 28.18 E GPS	5155	5157	10	5160	5242	34	1-8,12,13,23,24,26,27,43	
49MR0704_1	P01	27	1	ROS 080107 0419	EN 41 55.98 N 151 28.70 E GPS	5164	5166						
49MR0704_1	P01	28	1	ROS 080107 0659	BE 42 20.19 N 152 5.00 E GPS	5112	5110						
49MR0704_1	P01	28	1	BUC 080107 0706	UN 42 20.11 N 152 5.15 E GPS	5108	5107					1,83	16.0C
49MR0704_1	P01	28	1	ROS 080107 0819	BO 42 19.78 N 152 5.43 E GPS	5123	5121	10	5136	5202	33	1-8,27,37	
49MR0704_1	P01	28	1	ROS 080107 1021	EN 42 19.44 N 152 5.73 E GPS	5130	5128						
49MR0704_1	P01	29	1	ROS 080107 1257	BE 42 40.99 N 152 40.74 E GPS	5313	5313						

49MR0704_1	P01	29	1	BUC 080107 1306	UN 42 41.00 N 152 40.91 E GPS	5315	5314					1,31,33,34,82	16.0C
49MR0704_1	P01	29	1	ROS 080107 1414	BO 42 40.87 N 152 41.63 E GPS	5303	5309	-9	4997	5027	0		WINCH STOPPED (LONGLINE FOR FISHERY WAS CAUGHT IN A PROPELLER)
49MR0704_1	P01	29	1	ROS 080107 1438	UN 42 40.82 N 152 41.47 E GPS	5302	5302						QUITTED THIS CAST
49MR0704_1	P01	29	1	ROS 080107 1558	EN 42 40.95 N 152 42.03 E GPS	5293	5293						NO WATER SMPL
49MR0704_1		414	1	UNK 080207 0438	BE 42 46.69 N 152 56.91 E GPS	5133	5133						FOG WATER SMPL FOR TRACE ELEMENTS (#31)
49MR0704_1		414	1	UNK 080207 0635	EN 42 43.88 N 153 0.77 E GPS	5144	5144						FOG WATER SMPL FOR TRACE ELEMENTS (#32)
49MR0704_1		415	1	UNK 080207 0635	BE 42 43.88 N 153 0.77 E GPS	5144	5144						FOG WATER SMPL FOR TRACE ELEMENTS (#32)
49MR0704_1		415	1	UNK 080207 0845	EN 42 36.13 N 153 3.16 E GPS	5169	5169						FOG WATER SMPL FOR TRACE ELEMENTS (#33)
49MR0704_1		416	1	UNK 080207 1231	BE 42 23.08 N 153 2.95 E GPS	5150	5150						FOG WATER SMPL FOR TRACE ELEMENTS (#33)
49MR0704_1		416	1	UNK 080207 1429	EN 42 16.87 N 153 2.98 E GPS	5260	5260						FOG WATER SMPL FOR TRACE ELEMENTS (#34)
49MR0704_1		417	1	UNK 080207 1429	BE 42 16.87 N 153 2.98 E GPS	5260	5260						FOG WATER SMPL FOR TRACE ELEMENTS (#34)
49MR0704_1		417	1	UNK 080207 1745	EN 42 6.36 N 153 3.85 E GPS	5299	5299						FOG WATER SMPL FOR TRACE ELEMENTS (#35)
49MR0704_1		418	1	UNK 080407 0244	BE 40 10.95 N 153 0.17 E GPS	5707	5714						FOG WATER SMPL FOR TRACE ELEMENTS (#35)
49MR0704_1		418	1	UNK 080407 0458	EN 40 2.98 N 153 0.97 E GPS	5691	5698						FOG WATER SMPL FOR TRACE ELEMENTS (#36)
49MR0704_1		419	1	UNK 080407 0458	BE 40 2.98 N 153 0.97 E GPS	5691	5698						FOG WATER SMPL FOR TRACE ELEMENTS (#36)
49MR0704_1		419	1	UNK 080407 0753	EN 39 59.88 N 153 0.96 E GPS	5673	5680						FOG WATER SMPL FOR TRACE ELEMENTS (#36)
49MR0704_1		420	1	UNK 080507 0514	UN 40 13.66 N 152 49.85 E GPS	5719	5727						RAIN SMPL FOR STABLE ISOTOPE (#4, 4.7MM)
49MR0704_1		421	1	UNK 081007 0155	UN 40 30.65 N 147 57.61 E GPS	5329	5332						RAIN SMPL FOR STABLE ISOTOPE (#5, 2.1MM)
49MR0704_1		422	1	UNK 081107 1345	BE 45 2.98 N 158 40.69 E GPS	5267	5267						FOG WATER SMPL FOR TRACE ELEMENTS (#37)
49MR0704_1		422	1	UNK 081107 1558	EN 45 26.38 N 159 24.83 E GPS	5289	5289						FOG WATER SMPL FOR TRACE ELEMENTS (#37)
49MR0704_1		423	1	UNK 081107 1558	BE 45 26.38 N 159 24.83 E GPS	5289	5289						FOG WATER SMPL FOR TRACE ELEMENTS (#38)
49MR0704_1		423	1	UNK 081107 1828	EN 45 49.70 N 160 6.22 E GPS	5473	5473						FOG WATER SMPL FOR TRACE ELEMENTS (#38)
49MR0704_1	P01	40	1	ROS 081207 0149	BE 46 59.57 N 162 15.17 E GPS	5640	5640						REPLACED SEC TEMP SENSOR
49MR0704_1	P01	40	1	BUC 081207 0157	UN 46 59.61 N 162 15.15 E GPS	5647	5646					1,31,33,34,82,83	10.9C
49MR0704_1	P01	40	1	UNK 081207 0200	UN 46 59.63 N 162 15.16 E GPS	5646	5646						20L THROUGH HULL PUMP FOR R.N.
49MR0704_1	P01	40	1	ROS 081207 0319	BO 46 59.75 N 162 15.47 E GPS	5663	5662	9	5645	5776	29	1-6,23,24,26,31,33,34,37,64,81-83	#2,3 AT CHLOR MAX
49MR0704_1	P01	40	1	ROS 081207 0526	EN 47 0.04 N 162 16.10 E GPS	5670	5670						
49MR0704_1	P01	40	2	UNK 081207 0540	UN 47 0.17 N 162 18.00 E GPS	5645	5645						AIR N2O/CH4 AND COS SMPL
49MR0704_1	P01	41	1	XCT 081207 0843	DE 47 0.20 N 163 23.62 E GPS	5778	5779						TSK XCTD-1(MK-100) #03022140
49MR0704_1	P01	42	1	XCT 081207 1146	DE 47 0.20 N 164 30.55 E GPS	5845	5845						TSK XCTD-1(MK-100) #02121625
49MR0704_1	P01	43	1	XCT 081207 1444	DE 46 59.18 N 165 37.96 E GPS	5869	5869						TSK XCTD-1(MK-100) #02121627
49MR0704_1	P01	44	1	ROS 081207 1747	BE 47 0.08 N 166 44.71 E GPS	5951	5952						
49MR0704_1	P01	44	1	BUC 081207 1755	UN 47 0.01 N 166 44.83 E GPS	5951	5953					1,31,33,83	9.4C
49MR0704_1	P01	44	1	UNK 081207 1759	UN 46 59.97 N 166 44.84 E GPS	5953	5954						20L THROUGH HULL PUMP FOR R.N.
49MR0704_1	P01	44	1	ROS 081207 1918	BO 46 59.48 N 166 44.69 E GPS	5956	5957	-9	5922	6001	29	1-6,23,24,26,28,31,33,34,83	#2,3 AT CHLOR MAX
49MR0704_1	P01	44	1	ROS 081207 2129	EN 46 59.04 N 166 44.18 E GPS	5958	5959						
49MR0704_1	P01	45	1	XCT 081307 0038	DE 47 0.20 N 167 49.82 E GPS	6251	6251						TSK XCTD-1(MK-100) #03022141
49MR0704_1	P01	46	1	XCT 081307 0209	DE 46 59.92 N 168 22.31 E GPS	6261	6260						TSK XCTD-1(MK-100) #03022142
49MR0704_1	P01	47	1	XCT 081307 0353	DE 46 59.82 N 168 59.63 E GPS	5210	5210						TSK XCTD-1(MK-100) #03022176
49MR0704_1	P01	48	1	XCT 081307 0415	DE 46 59.98 N 169 5.89 E GPS	4180	4180						TSK XCTD-1(MK-100) #03022171
49MR0704_1	P01	49	1	XCT 081307 0433	DE 47 0.01 N 169 10.84 E GPS	2718	2718						TSK XCTD-1(MK-100) #03022174
49MR0704_1	P01	50	1	XCT 081307 0543	DE 46 59.38 N 169 34.52 E GPS	2385	2385						TSK XCTD-1(MK-100) #03022172
49MR0704_1	P01	51	1	XCT 081307 0631	DE 46 58.76 N 169 49.77 E GPS	4209	4209						TSK XCTD-1(MK-100) #03022170
49MR0704_1	P01	52	1	XCT 081307 0710	DE 46 59.60 N 170 0.99 E GPS	4999	4999						TSK XCTD-1(MK-100) #03022149
49MR0704_1	P01	53	1	XCT 081307 0829	DE 47 0.27 N 170 28.53 E GPS	6344	6344						TSK XCTD-1(MK-100) #03022148
49MR0704_1	P01	54	1	XCT 081307 1135	DE 47 0.30 N 171 36.59 E GPS	6102	6101						TSK XCTD-1(MK-100) #03022146
49MR0704_1	P01	55	1	XCT 081307 1433	DE 47 0.30 N 172 42.65 E GPS	5608	5608						TSK XCTD-1(MK-100) #03022152
49MR0704_1	P01	56	1	XCT 081307 1729	DE 47 0.43 N 173 50.82 E GPS	5785	5785						TSK XCTD-1(MK-100) #03022147
49MR0704_1	P01	57	1	XCT 081307 2030	DE 47 0.40 N 174 58.51 E GPS	5706	5706						TSK XCTD-1(MK-100) #03022151
49MR0704_1	P01	58	1	ROS 081307 2341	BE 46 59.64 N 176 5.68 E GPS	5698	5698						REPLACED PRI TEMP SENSOR

49MR0704_1	P01	58	1	BUC 081307 2348	UN 46 59.71 N 176 5.67 E GPS	5696	5696				1,31,33,34,82,83	12.0C
49MR0704_1	P01	58	1	UNK 081307 2350	UN 46 59.72 N 176 5.68 E GPS	5695	5694					20L THROUGH HULL PUMP FOR R.N.
49MR0704_1	P01	58	1	ROS 081407 0025	UN 46 59.89 N 176 5.84 E GPS	5696	5696					LOST PRI TEMP SIGNAL AT 2400M
49MR0704_1	P01	58	1	ROS 081407 0100	EN 47 0.06 N 176 6.01 E GPS	5695	5695					QUITED THIS CAST
49MR0704_1	P01	58	2	ROS 081407 0153	BE 46 59.48 N 176 5.36 E GPS	5695	5694					REPLACED PRI TEMP CABLE
49MR0704_1	P01	58	2	ROS 081407 0321	BO 46 59.84 N 176 5.68 E GPS	5696	5696	11	5711	5801	29 1-6,23,24,26,31,33,34,37,81-83	#2,3 AT CHLOR MAX
49MR0704_1	P01	58	2	ROS 081407 0526	EN 47 0.12 N 176 6.61 E GPS	5694	5694					
49MR0704_1	P01	58	2	UNK 081407 0550	UN 47 0.15 N 176 12.35 E GPS	5502	5502					AIR N2O/CH4 AND COS SMPL
49MR0704_1	P01	59	1	XCT 081407 0830	DE 47 0.29 N 177 11.50 E GPS	5664	5665					TSK XCTD-1 (MK-100) #03022144
49MR0704_1	P01	60	1	ROS 081407 1138	BE 46 59.78 N 178 18.24 E GPS	5756	5756					CHANGED PRI PUMP WITH SEC PUMP
49MR0704_1	P01	60	1	BUC 081407 1146	UN 46 59.85 N 178 18.27 E GPS	5760	5760				1,31,33,83	12.1C
49MR0704_1	P01	60	1	UNK 081407 1148	UN 46 59.86 N 178 18.26 E GPS	5757	5757					20L THROUGH HULL PUMP FOR R.N.
49MR0704_1	P01	60	1	ROS 081407 1309	BO 47 0.17 N 178 18.27 E GPS	5765	5765	9	5779	5867	28 1-6,23,24,26,31,33,34,37	#2,3 AT CHLOR MAX
49MR0704_1	P01	60	1	ROS 081407 1527	EN 47 0.47 N 178 18.30 E GPS	5752	5752					
49MR0704_1	P01	61	1	ROS 081407 1851	BE 47 0.43 N 179 26.65 E GPS	5560	5561					
49MR0704_1	P01	61	1	BUC 081407 1900	UN 47 0.50 N 179 26.56 E GPS	5555	5555				1,83	12.3C
49MR0704_1	P01	61	1	ROS 081407 2019	BO 47 0.75 N 179 26.90 E GPS	5629	5630	9	5619	5701	36 1-8,27,37	#3=#23 DUPLICATE SMPL
49MR0704_1	P01	61	1	ROS 081407 2235	EN 47 0.86 N 179 26.92 E GPS	5640	5640					
49MR0704_1	P01	62	1	ROS 081507 0152	BE 46 59.45 N 179 25.69 W GPS	5718	5718					
49MR0704_1	P01	62	1	BUC 081507 0200	UN 46 59.49 N 179 25.70 W GPS	5719	5718				1,31,33,34,82	12.6C
49MR0704_1	P01	62	1	ROS 081507 0322	BO 46 59.68 N 179 25.77 W GPS	5722	5721	9	5750	5840	36 1-8,23,24,26,27,31,33,34,82	
49MR0704_1		424	1	UNK 081507 0342	BE 46 59.71 N 179 25.77 W GPS	5724	5723					RAIN SMPL FOR TRACE ELEMENTS (#21)
49MR0704_1		425	1	UNK 081507 0523	UN 47 0.06 N 179 25.88 W GPS	5652	5652					RAIN SMPL FOR STABLE ISOTOPE (#6, 1.8MM)
49MR0704_1		424	1	UNK 081507 0532	EN 47 0.28 N 179 25.78 W GPS	5604	5603					
49MR0704_1		426	1	UNK 081507 0532	BE 47 0.28 N 179 25.78 W GPS	5604	5603					RAIN SMPL FOR TRACE ELEMENTS (#22)
49MR0704_1	P01	62	1	ROS 081507 0544	EN 47 0.26 N 179 25.93 W GPS	5608	5607					AIR N2O/CH4 SMPL
49MR0704_1	P01	62	1	UNK 081507 0558	UN 47 0.31 N 179 24.02 W GPS	5618	5617					
49MR0704_1	P01	63	1	ROS 081507 0905	BE 46 59.41 N 178 19.08 W GPS	5674	5673					
49MR0704_1	P01	63	1	BUC 081507 0912	UN 46 59.47 N 178 19.01 W GPS	5643	5643				1,83	13.0C
49MR0704_1	P01	63	1	ROS 081507 1031	BO 46 59.81 N 178 18.46 W GPS	5503	5503	9	5559	5630	36 1-8,23,27,28,34,37,81	#2 AT CHLOR MAX
49MR0704_1		426	1	UNK 081507 1050	EN 46 59.90 N 178 18.33 W GPS	5502	5502					
49MR0704_1		427	1	UNK 081507 1050	BE 46 59.90 N 178 18.33 W GPS	5502	5502					RAIN SMPL FOR TRACE ELEMENTS (#23)
49MR0704_1		428	1	UNK 081507 1144	UN 47 0.13 N 178 17.84 W GPS	5495	5495					RAIN SMPL FOR STABLE ISOTOPE (#7, 5.6MM)
49MR0704_1	P01	63	1	ROS 081507 1255	EN 47 0.28 N 178 17.32 W GPS	5509	5509					
49MR0704_1		429	1	UNK 081507 1340	BE 47 0.19 N 178 4.79 W GPS	5642	5642					FOG WATER SMPL FOR TRACE ELEMENTS (#39)
49MR0704_1	P01	64	1	ROS 081507 1605	BE 46 59.67 N 177 13.07 W GPS	5700	5701					
49MR0704_1	P01	64	1	BUC 081507 1620	UN 46 59.78 N 177 12.96 W GPS	5706	5706				1	13.7C
49MR0704_1	P01	64	1	ROS 081507 1742	BO 46 59.96 N 177 12.63 W GPS	5709	5710	8	5732	5823	35 1-8,23,24,26,27	
49MR0704_1		429	1	UNK 081507 1755	EN 46 59.98 N 177 12.60 W GPS	5710	5711					
49MR0704_1		427	1	UNK 081507 1755	EN 46 59.98 N 177 12.60 W GPS	5710	5711					
49MR0704_1		430	1	UNK 081507 1755	BE 46 59.98 N 177 12.60 W GPS	5710	5711					RAIN SMPL FOR TRACE ELEMENTS (#24)
49MR0704_1	P01	64	1	ROS 081507 2002	EN 47 0.36 N 177 11.63 W GPS	5710	5711					
49MR0704_1		431	1	UNK 081507 2033	UN 47 0.31 N 177 4.46 W GPS	5625	5626					RAIN SMPL FOR STABLE ISOTOPE (#8, 1.8MM)
49MR0704_1		430	1	UNK 081507 2120	EN 47 0.02 N 176 46.75 W GPS	5629	5629					
49MR0704_1	P01	65	1	ROS 081507 2333	BE 47 0.76 N 176 3.09 W GPS	5633	5633					
49MR0704_1	P01	65	1	BUC 081507 2340	UN 47 0.75 N 176 3.08 W GPS	5636	5636				1	13.9C
49MR0704_1	P01	65	1	UNK 081507 2343	UN 47 0.76 N 176 3.09 W GPS	5634	5634					100L THROUGH HULL PUMP FOR R.N.
49MR0704_1	P01	65	1	ROS 081607 0059	BO 47 0.74 N 176 2.68 W GPS	5637	5637	9	5650	5735	36 1-8,22,27	
49MR0704_1	P01	65	1	ROS 081607 0326	EN 47 0.67 N 176 1.95 W GPS	5634	5633					
49MR0704_1	P01	66	1	ROS 081607 0633	BE 47 0.45 N 174 57.84 W GPS	5790	5789					
49MR0704_1	P01	66	1	BUC 081607 0641	UN 47 0.45 N 174 57.74 W GPS	5788	5788				1,31,33	13.8C

49MR0704_1	P01	66	1	ROS 081607 0802	BO 47 0.31 N 174 57.28 W GPS	5787	5787	9	5766	5853	36	1-8,12,13,23,24,26,27,31,33	
49MR0704_1	P01	66	1	ROS 081607 1022	EN 46 59.91 N 174 56.07 W GPS	5794	5794						
49MR0704_1		432	1	UNK 081607 1048	BE 46 59.86 N 174 50.96 W GPS	5747	5746						FOG WATER SMPL FOR TRACE ELEMENTS (#40)
49MR0704_1		432	1	UNK 081607 1335	EN 46 59.91 N 173 48.11 W GPS	5706	5706						
49MR0704_1	P01	67	1	ROS 081607 1344	BE 46 59.88 N 173 48.08 W GPS	5716	5715						
49MR0704_1	P01	67	1	BUC 081607 1352	UN 46 59.92 N 173 48.04 W GPS	5724	5723				1,83		13.7C
49MR0704_1		433	1	UNK 081607 1427	BE 46 59.91 N 173 47.90 W GPS	5722	5722						RAIN SMPL FOR TRACE ELEMENTS (#25)
49MR0704_1	P01	67	1	ROS 081607 1513	BO 47 0.05 N 173 47.76 W GPS	5724	5724	9	5745	5830	35	1-8,27,28,37	
49MR0704_1		434	1	UNK 081607 1622	UN 47 0.00 N 173 47.37 W GPS	5722	5722						RAIN SMPL FOR STABLE ISOTOPE (#9, 0.6MM)
49MR0704_1	P01	67	1	ROS 081607 1737	EN 46 59.97 N 173 46.96 W GPS	5719	5719						
49MR0704_1		433	1	UNK 081607 1844	EN 46 59.82 N 173 26.25 W GPS	5633	5632						
49MR0704_1		435	1	UNK 081607 1844	BE 46 59.82 N 173 26.25 W GPS	5633	5632						RAIN SMPL FOR TRACE ELEMENTS (#26)
49MR0704_1		435	1	UNK 081607 2030	EN 46 59.78 N 172 42.54 W GPS	5790	5790						
49MR0704_1	P01	68	1	ROS 081607 2049	BE 46 59.67 N 172 42.89 W GPS	5795	5794						
49MR0704_1	P01	68	1	BUC 081607 2059	UN 46 59.77 N 172 42.70 W GPS	5763	5762				1		14.1C
49MR0704_1		436	1	UNK 081607 2059	UN 46 59.78 N 172 42.69 W GPS	5763	5762						RAIN SMPL FOR STABLE ISOTOPE (#10, 12.6MM)
49MR0704_1	P01	68	1	ROS 081607 2219	BO 46 59.74 N 172 42.36 W GPS	5793	5792	9	5789	5883	36	1-8,23,24,26,27	
49MR0704_1		437	1	UNK 081607 2345	BE 46 59.68 N 172 41.89 W GPS	5804	5803						FOG WATER SMPL FOR TRACE ELEMENTS (#41)
49MR0704_1	P01	68	1	ROS 081707 0049	EN 46 59.53 N 172 41.26 W GPS	5814	5814						
49MR0704_1	P01	68	1	FLT 081707 0058	DE 46 59.46 N 172 41.04 W GPS	5825	5824						ARGO #2811/ID66102
49MR0704_1		437	1	UNK 081707 0101	EN 46 59.45 N 172 40.82 W GPS	5828	5827						
49MR0704_1		438	1	UNK 081707 0101	BE 46 59.45 N 172 40.82 W GPS	5828	5827						FOG WATER SMPL FOR TRACE ELEMENTS (#42)
49MR0704_1		438	1	UNK 081707 0314	EN 47 0.21 N 171 50.05 W GPS	5765	5766						
49MR0704_1		439	1	UNK 081707 0405	BE 47 0.41 N 171 33.34 W GPS	5753	5755						RAIN SMPL FOR TRACE ELEMENTS (#27)
49MR0704_1	P01	69	1	ROS 081707 0408	BE 47 0.35 N 171 33.27 W GPS	5767	5767						
49MR0704_1	P01	69	1	BUC 081707 0417	UN 47 0.31 N 171 33.15 W GPS	5764	5764				1,83		14.5C
49MR0704_1	P01	69	1	ROS 081707 0540	BO 47 0.49 N 171 33.43 W GPS	5732	5732	12	5769	5864	36	1-8,27,37,83	
49MR0704_1		440	1	UNK 081707 0638	UN 47 0.69 N 171 33.43 W GPS	5717	5717						RAIN SMPL FOR STABLE ISOTOPE (#11, 6.4MM)
49MR0704_1	P01	69	1	ROS 081707 0758	EN 47 0.69 N 171 33.32 W GPS	5731	5731						
49MR0704_1		439	1	UNK 081707 0818	EN 47 0.68 N 171 29.22 W GPS	5721	5720						
49MR0704_1	P01	70	1	ROS 081707 1124	BE 47 0.11 N 170 26.38 W GPS	5587	5586						
49MR0704_1	P01	70	1	BUC 081707 1132	UN 47 0.10 N 170 26.37 W GPS	5593	5592				1,31,33,34,82		13.9C
49MR0704_1	P01	70	1	ROS 081707 1252	BO 46 59.95 N 170 25.77 W GPS	5520	5520	10	5592	5666	36	1-8,23,24,26,27,31,33,34,81,82	#2 AT CHLOR MAX
49MR0704_1	P01	70	1	ROS 081707 1519	EN 46 59.31 N 170 24.12 W GPS	5427	5426						
49MR0704_1	P01	70	1	UNK 081707 1530	UN 46 59.28 N 170 23.70 W GPS	5463	5461						AIR N2O/CH4 SMPL
49MR0704_1		441	1	UNK 081707 1616	UN 46 59.67 N 170 5.54 W GPS	5293	5294						RAIN SMPL FOR STABLE ISOTOPE (#12, 3.2MM)
49MR0704_1		442	1	UNK 081707 1623	BE 46 59.66 N 170 2.97 W GPS	5510	5510						FOG WATER SMPL FOR TRACE ELEMENTS (#43)
49MR0704_1	P01	71	1	ROS 081707 1820	BE 46 59.96 N 169 21.11 W GPS	5608	5608						
49MR0704_1	P01	71	1	BUC 081707 1831	UN 46 59.85 N 169 20.81 W GPS	5617	5616				1		13.9C
49MR0704_1	P01	71	1	UNK 081707 1833	UN 46 59.85 N 169 20.79 W GPS	5613	5613						100L THROUGH HULL PUMP FOR R.N.
49MR0704_1		442	1	UNK 081707 1859	EN 46 59.75 N 169 20.68 W GPS	5618	5618						
49MR0704_1		443	1	UNK 081707 1859	BE 46 59.75 N 169 20.68 W GPS	5618	5618						FOG WATER SMPL FOR TRACE ELEMENTS (#44)
49MR0704_1		444	1	UNK 081707 1859	BE 46 59.75 N 169 20.68 W GPS	5618	5618						RAIN SMPL FOR TRACE ELEMENTS (#28)
49MR0704_1	P01	71	1	ROS 081707 1948	BO 46 59.67 N 169 20.55 W GPS	5617	5617	8	5635	5726	36	1-8,22,27	
49MR0704_1	P01	71	1	ROS 081707 2203	EN 46 59.63 N 169 20.11 W GPS	5619	5620						
49MR0704_1	P01	72	1	UNK 081707 2220	UN 46 59.60 N 169 17.75 W GPS	5620	5620						AIR COS SMPL
49MR0704_1		443	1	UNK 081707 2230	EN 46 59.66 N 169 14.54 W GPS	5569	5569						
49MR0704_1		444	1	UNK 081707 2230	EN 46 59.60 N 169 14.54 W GPS	5569	5569						
49MR0704_1	P01	72	1	ROS 081807 0131	BE 47 0.21 N 168 13.17 W GPS	5401	5403						
49MR0704_1	P01	72	1	BUC 081807 0142	UN 47 0.14 N 168 13.06 W GPS	5395	5398				1		14.8C
49MR0704_1	P01	72	1	ROS 081807 0258	BO 46 59.99 N 168 12.63 W GPS	5403	5405	9	5431	5499	36	1-8,12,13,23,24,26,27,40,43	

49MR0704_1	P01	84	1	BUC 082107 1408	UN 46 59.45 N 154 46.28 W GPS	5206	5208				1,83	14.1C	
49MR0704_1		446	1	UNK 082107 1445	BE 46 59.53 N 154 46.14 W GPS	5203	5204					FOG WATER SMPL FOR TRACE ELEMENTS (#45)	
49MR0704_1	P01	84	1	ROS 082107 1521	BO 46 59.64 N 154 45.92 W GPS	5205	5206	8	5229	5297	34	1-8,27,28,37	
49MR0704_1		446	1	UNK 082107 1715	EN 46 59.74 N 154 45.15 W GPS	5207	5209						
49MR0704_1	P01	84	1	ROS 082107 1721	EN 46 59.76 N 154 45.04 W GPS	5206	5208						
49MR0704_1		447	1	UNK 082107 1834	BE 46 59.64 N 154 19.93 W GPS	5187	5187					FOG WATER SMPL FOR TRACE ELEMENTS (#46)	
49MR0704_1		447	1	UNK 082107 2024	EN 47 0.20 N 153 39.20 W GPS	5221	5220						
49MR0704_1	P01	85	1	ROS 082107 2033	BE 47 0.08 N 153 38.28 W GPS	5222	5221						
49MR0704_1	P01	85	1	BUC 082107 2040	UN 47 0.07 N 153 38.19 W GPS	5224	5222				1	14.3C	
49MR0704_1		448	1	UNK 082107 2125	BE 47 0.00 N 153 37.88 W GPS	5222	5221					FOG WATER SMPL FOR TRACE ELEMENTS (#47)	
49MR0704_1	P01	85	1	ROS 082107 2154	BO 47 0.00 N 153 37.66 W GPS	5223	5222	9	5249	5314	33	1-8,23,24,26,27	
49MR0704_1		448	1	UNK 082107 2348	EN 46 59.93 N 153 37.03 W GPS	5227	5226						
49MR0704_1	P01	85	1	ROS 082207 0004	EN 46 59.91 N 153 36.93 W GPS	5227	5225						
49MR0704_1		449	1	UNK 082207 0037	BE 46 59.86 N 153 29.05 W GPS	5220	5219					FOG WATER SMPL FOR TRACE ELEMENTS (#48)	
49MR0704_1		449	1	UNK 082207 0249	EN 46 59.64 N 152 38.20 W GPS	5237	5238						
49MR0704_1	P01	86	1	ROS 082207 0313	BE 46 59.52 N 152 32.49 W GPS	5199	5199						
49MR0704_1		450	1	UNK 082207 0315	UN 46 59.53 N 152 32.42 W GPS	5207	5208					RAIN SMPL FOR STABLE ISOTOPE (#14, 0.6MM)	
49MR0704_1	P01	86	1	BUC 082207 0320	UN 46 59.53 N 152 32.38 W GPS	5208	5210				1	14.3C	
49MR0704_1	P01	86	1	UNK 082207 0329	UN 46 59.53 N 152 32.32 W GPS	5210	5211					95L THROUGH HULL PUMP FOR R.N.	
49MR0704_1	P01	86	1	ROS 082207 0434	BO 46 59.42 N 152 31.84 W GPS	5195	5195	10	5241	5301	36	1-8,22,27	
49MR0704_1		451	1	UNK 082207 0544	BE 46 59.20 N 152 31.20 W GPS	5196	5197					FOG WATER SMPL FOR TRACE ELEMENTS (#49)	
49MR0704_1		452	1	UNK 082207 0634	UN 46 59.03 N 152 30.66 W GPS	5221	5221					RAIN SMPL FOR STABLE ISOTOPE (#15, 1.2MM)	
49MR0704_1	P01	86	1	ROS 082207 0638	EN 46 59.01 N 152 30.61 W GPS	5226	5226						
49MR0704_1		451	1	UNK 082207 0640	EN 46 59.01 N 152 30.61 W GPS	5222	5222						
49MR0704_1		453	1	UNK 082207 0649	BE 46 58.37 N 152 30.69 W GPS	5230	5230					3-AXIS MAGNETOMETER CALIBRATION	
49MR0704_1		453	1	UNK 082207 0717	EN 46 58.33 N 152 30.38 W GPS	5249	5250						
49MR0704_1	P01	X16	1	ROS 082207 1630	BE 47 0.35 N 152 0.22 W GPS	5117	5116						
49MR0704_1	P01	X16	1	BUC 082207 1640	UN 47 0.23 N 152 0.18 W GPS	5136	5135				1	14.1C	
49MR0704_1	P01	X16	1	ROS 082207 1749	BO 46 59.79 N 151 59.86 W GPS	5132	5131	8	5176	5227	33	1-8,12,13,23,24,26,27	
49MR0704_1	P01	X16	1	ROS 082207 1950	EN 46 59.31 N 151 59.51 W GPS	5166	5165						
49MR0704_1	P01	87	1	ROS 082207 2148	BE 47 0.44 N 151 25.21 W GPS	5141	5140						
49MR0704_1	P01	87	1	BUC 082207 2157	UN 47 0.37 N 151 25.18 W GPS	5139	5138				1,31,33,34,82	13.9C	
49MR0704_1	P01	87	1	UNK 082207 2230	UN 47 0.22 N 151 25.04 W GPS	5153	5151					AIR N2O/CH4 AND COS SMPL	
49MR0704_1	P01	87	1	ROS 082207 2310	BO 47 0.11 N 151 24.92 W GPS	5177	5177	8	5192	5266	34	1-8,23,24,26,27,31,33,34,81,82	#2 AT CHLOR MAX
49MR0704_1	P01	87	1	ROS 082307 0124	EN 46 59.80 N 151 24.48 W GPS	5149	5148						
49MR0704_1	P01	87	1	FLT 082307 0132	DE 46 59.69 N 151 24.37 W GPS	5164	5164					ARGO #2352/ID60118	
49MR0704_1	P01	88	1	ROS 082307 0442	BE 46 59.64 N 150 18.01 W GPS	5037	5037						
49MR0704_1	P01	88	1	BUC 082307 0449	UN 46 59.61 N 150 17.90 W GPS	5043	5043				1,83	14.1C	
49MR0704_1	P01	88	1	ROS 082307 0600	BO 46 59.35 N 150 17.70 W GPS	5052	5043	10	5059	5131	33	1-8,27,37,83	
49MR0704_1	P01	88	1	ROS 082307 0758	EN 46 58.80 N 150 17.20 W GPS	4993	4994						
49MR0704_1		454	1	UNK 082307 0906	BE 46 59.06 N 149 54.84 W GPS	5147	5148					FOG WATER SMPL FOR TRACE ELEMENTS (#50)	
49MR0704_1		454	1	UNK 082307 1039	EN 46 59.98 N 149 18.78 W GPS	5073	5074						
49MR0704_1	P01	89	1	ROS 082307 1115	BE 46 59.82 N 149 9.04 W GPS	5058	5058					FOG	
49MR0704_1	P01	89	1	BUC 082307 1125	UN 46 59.77 N 149 8.83 W GPS	5057	5058				1	13.8C	
49MR0704_1		455	1	UNK 082307 1147	BE 46 59.66 N 149 8.75 W GPS	5055	5055					FOG WATER SMPL FOR TRACE ELEMENTS (#51)	
49MR0704_1	P01	89	1	ROS 082307 1236	BO 46 59.50 N 149 8.67 W GPS	5058	5058	10	5068	5140	33	1-8,23,24,26,27	
49MR0704_1		455	1	UNK 082307 1347	EN 46 59.98 N 149 8.70 W GPS	5056	5056						
49MR0704_1	P01	89	1	ROS 082307 1442	EN 46 58.82 N 149 8.54 W GPS	5053	5053						
49MR0704_1		456	1	UNK 082307 1516	BE 46 58.77 N 148 59.21 W GPS	5029	5028					FOG WATER SMPL FOR TRACE ELEMENTS (#52)	
49MR0704_1		456	1	UNK 082307 1735	EN 47 0.59 N 148 7.88 W GPS	5007	5007						
49MR0704_1	P01	90	1	ROS 082307 1759	BE 47 0.66 N 148 2.67 W GPS	5004	5003						

49MR0704_1	P01	111	1	BUC	082807	1745	UN	47	0.21	N	126	28.45	W	GPS	2548	2548				1,83	18.3C	
49MR0704_1	P01	111	1	ROS	082807	1821	BO	47	0.30	N	126	28.27	W	GPS	2550	2550	9	2556	2572	24	1-8,27,28,37,83	
49MR0704_1	P01	111	1	ROS	082807	1928	EN	47	0.26	N	126	27.88	W	GPS	2550	2550						
49MR0704_1	P01	112	1	ROS	082807	2101	BE	47	0.19	N	126	0.30	W	GPS	2558	2558						
49MR0704_1	P01	112	1	BUC	082807	2111	UN	47	0.24	N	126	0.30	W	GPS	2558	2557					1	18.6C
49MR0704_1	P01	112	1	ROS	082807	2147	BO	47	0.31	N	126	0.17	W	GPS	2552	2552	9	2562	2581	23	1-8,23,24,26,27,	
49MR0704_1	P01	112	1	ROS	082807	2259	EN	47	0.27	N	125	59.68	W	GPS	2535	2535						
49MR0704_1	P01	113	1	ROS	082907	0037	BE	47	0.35	N	125	30.55	W	GPS	1751	1750						
49MR0704_1	P01	113	1	BUC	082907	0046	UN	47	0.32	N	125	30.56	W	GPS	1750	1750					1	18.7C
49MR0704_1	P01	113	1	ROS	082907	0110	BO	47	0.25	N	125	30.62	W	GPS	1756	1757	9	1744	1756	18	1-8,23,24,26,27	
49MR0704_1	P01	113	1	ROS	082907	0158	EN	47	0.06	N	125	30.67	W	GPS	1749	1749						
49MR0704_1	P01	114	1	ROS	082907	0358	BE	47	0.02	N	125	3.38	W	GPS	906	906						
49MR0704_1	P01	114	1	BUC	082907	0406	UN	46	59.97	N	125	3.41	W	GPS	952	952					1,31,33,34,82,83	18.1C
49MR0704_1	P01	114	1	ROS	082907	0421	BO	46	59.94	N	125	3.48	W	GPS	986	986	22	944	950	16	1-8,23,24,26,27,31,33,34,37,81,82	HAB MEASURED BY IADCP AIR N2O/CH4 AND COS SMPL
49MR0704_1	P01	114	1	UNK	082907	0440	UN	46	59.91	N	125	3.57	W	GPS	1031	1031						
49MR0704_1	P01	114	1	ROS	082907	0459	EN	46	59.87	N	125	3.64	W	GPS	1038	1038						
49MR0704_1	P01	115	1	ROS	082907	0655	BE	46	56.34	N	124	58.91	W	GPS	280	280						
49MR0704_1	P01	115	1	BUC	082907	0657	UN	46	56.32	N	124	58.93	W	GPS	306	306					1	17.8C
49MR0704_1	P01	115	1	ROS	082907	0708	BO	46	56.30	N	124	59.02	W	GPS	287	287	10	318	322	6	1-8,27	
49MR0704_1	P01	115	1	ROS	082907	0721	EN	46	56.28	N	124	59.10	W	GPS	299	299						
49MR0704_1		463	1	UNK	082907	0831	BE	47	3.83	N	125	17.09	W	GPS	1746	1746						FOG WATER SMPL FOR TRACE ELEMENTS (#56)
49MR0704_1		463	1	UNK	082907	1247	EN	47	33.39	N	126	38.78	W	GPS	2381	2381						

Parameter

1=Salinity, 2=Oxygen, 3=Silicate, 4=Nitrate, 5=Nitrite, 6=PHOSPHATE, 7=CFC-11, 8=CFC-12, 12= $\delta^{14}\text{C}$, 13= $\delta^{13}\text{C}$, 22= ^{137}CS , 23= Total carbon, 24=Alkalinity, 26=PH, 27=CFC-113, 28=Carbon tetrachloride, 31= CH_4 , 33= N_2O , 34=Chlorophyll a, 37=Biogenic sulfur compounds, 40=Particulate organic carbon, 42= Abundance of bacteria, 47=Plutonium, 64= Incubation, 81= Particulate organic matter, 82= $^{15}\text{NO}_3$, 83=Particulate inorganic matter

49MR0706_1.sum file

P01/P14 REV R/V MIRAI CRUISE MR0706

SHIP/CRS	WOCE	CAST		UTC EVENT		POSITION			UNC	COR	HT ABOVE	WIRE	MAX	NO. OF	COMMENTS			
EXPOCODE	SECT	STNNBR	CASTNO	TYPE	DATE	TIME	CODE	LATITUDE	LONGITUDE	NAV	DEPTH	DEPTH	BOTTOM	OUT		PRESS	BOTTLES	PARAMETERS
49MR0706_1		601	1	UNK	100807	0245	UN 40	34.48 N	141 31.99 E	GPS	-9	-9						RAIN SMPL FOR STABLE ISOTOPE #1
49MR0706_1		602	1	UNK	100907	0208	BE 40	34.29 N	144 33.80 E	GPS	7425	-9						RELEASING EXCESS TWIST OF CTD CABLE
49MR0706_1		602	1	UNK	100907	0703	EN 40	31.70 N	144 32.76 E	GPS	7383	-9						WOUT 7000M, WEIGHT OF 300KG WITH COMPASS/TILT METER
49MR0706_1		603	1	UNK	100907	0855	UN 40	29.45 N	145 3.27 E	GPS	5955	-9						RAIN SMPL FOR STABLE ISOTOPE #2
49MR0706_1	P01	28	2	ROS	101007	1028	BE 42	20.11 N	152 5.48 E	GPS	5120	5113						
49MR0706_1	P01	28	2	BUC	101007	1036	UN 42	20.07 N	152 5.47 E	GPS	5123	5115					1	15.2C
49MR0706_1	P01	28	2	ROS	101007	1149	BO 42	19.82 N	152 5.43 E	GPS	5127	5119	11	5135	5205		33	1-8,27
49MR0706_1	P01	28	2	ROS	101007	1409	EN 42	19.50 N	152 5.52 E	GPS	5130	5126						
49MR0706_1	P01	29	2	ROS	101007	2204	BE 42	41.09 N	152 41.25 E	GPS	5313	5312						
49MR0706_1	P01	29	2	BUC	101007	2213	UN 42	41.08 N	152 41.28 E	GPS	5311	5310					1	15.1C
49MR0706_1	P01	29	2	ROS	101007	2328	BO 42	40.89 N	152 41.30 E	GPS	5308	5307	11	5328	5400		34	1-8,23,24,26,27
49MR0706_1	P01	29	2	ROS	101107	0149	EN 42	40.24 N	152 41.14 E	GPS	5311	5310						A SHRIMP IN SEC TC-DUCT
49MR0706_1	P01	30	1	ROS	101107	0447	BE 43	5.50 N	153 19.50 E	GPS	5165	5164						
49MR0706_1	P01	30	1	BUC	101107	0456	UN 43	5.41 N	153 19.48 E	GPS	5163	5161					1	14.9C
49MR0706_1	P01	30	1	ROS	101107	0609	BO 43	4.92 N	153 19.50 E	GPS	5165	5163	11	5212	5261		34	1-8,27,28
49MR0706_1	P01	30	1	ROS	101107	0825	EN 43	5.45 N	153 20.14 E	GPS	5175	5173						
49MR0706_1	P01	32	1	ROS	101107	1442	BE 44	4.79 N	154 58.18 E	GPS	5357	5356						
49MR0706_1	P01	32	1	BUC	101107	1452	UN 44	4.80 N	154 58.30 E	GPS	5359	5358					1	12.7C
49MR0706_1	P01	32	1	ROS	101107	1606	BO 44	4.83 N	154 58.96 E	GPS	5344	5343	10	5401	5452		34	1-8,12,13,23,24,26,27
49MR0706_1	P01	32	1	ROS	101107	1828	EN 44	4.73 N	154 59.87 E	GPS	5312	5312						
49MR0706_1		604	1	UNK	101107	2141	UN 43	37.71 N	154 17.07 E	GPS	5553	5555						RAIN SMPL FOR STABLE ISOTOPE #3
49MR0706_1	P01	31	1	ROS	101107	2220	BE 43	33.88 N	154 9.43 E	GPS	5452	5452						
49MR0706_1	P01	31	1	BUC	101107	2228	UN 43	33.90 N	154 9.49 E	GPS	5455	5455					1	14.5C
49MR0706_1	P01	31	1	UNK	101107	2252	UN 43	33.94 N	154 9.81 E	GPS	5450	5451						80L THROUGH HULL PUMP FOR R.N.
49MR0706_1	P01	31	1	ROS	101107	2344	BO 43	33.88 N	154 10.25 E	GPS	5453	5454	10	5486	5551		36	1-8,22,27
49MR0706_1	P01	31	1	ROS	101207	0203	EN 43	33.84 N	154 11.73 E	GPS	5474	5475						
49MR0706_1	P01	33	1	ROS	101207	0813	BE 44	34.58 N	155 47.29 E	GPS	5132	5133						
49MR0706_1	P01	33	1	BUC	101207	0822	UN 44	34.58 N	155 47.34 E	GPS	5135	5135					1	12.2C
49MR0706_1	P01	33	1	ROS	101207	0933	BO 44	34.55 N	155 47.75 E	GPS	5138	5138	11	5157	5228		34	1-8,27
49MR0706_1	P01	33	1	ROS	101207	1150	EN 44	34.42 N	155 48.73 E	GPS	5147	5146						
49MR0706_1	P01	34	1	ROS	101207	1520	BE 45	4.26 N	156 38.00 E	GPS	4778	4778						
49MR0706_1	P01	34	1	BUC	101207	1528	UN 45	4.25 N	156 38.08 E	GPS	4785	4786					1	11.0C
49MR0706_1	P01	34	1	ROS	101207	1636	BO 45	4.38 N	156 38.23 E	GPS	4766	4766	10	4787	4852		32	1-8,23,24,26,27
49MR0706_1	P01	34	1	ROS	101207	1856	EN 45	4.91 N	156 38.80 E	GPS	4734	4734						
49MR0706_1	P01	35	1	ROS	101207	2233	BE 45	33.85 N	157 28.69 E	GPS	5032	5031						NO HEAVE MOTION OF CRANE
49MR0706_1	P01	35	1	BUC	101207	2240	UN 45	33.86 N	157 28.70 E	GPS	5037	5037					1	10.1C
49MR0706_1	P01	35	1	ROS	101207	2351	BO 45	33.83 N	157 29.10 E	GPS	5022	5022	10	5045	5100		32	1-8,27,28
49MR0706_1	P01	35	1	ROS	101307	0155	EN 45	32.76 N	157 30.02 E	GPS	4995	4995						
49MR0706_1	P01	36	1	ROS	101307	1111	BE 46	4.32 N	158 19.66 E	GPS	4833	4836						
49MR0706_1	P01	36	1	BUC	101307	1132	UN 46	4.24 N	158 19.52 E	GPS	4837	4836					1	9.5C
49MR0706_1	P01	36	1	ROS	101307	1236	BO 46	3.93 N	158 19.56 E	GPS	4835	4835	11	4851	4914		32	1-8,23,24,26,27
49MR0706_1	P01	36	1	ROS	101307	1445	EN 46	3.41 N	158 20.21 E	GPS	4816	4816						
49MR0706_1	P01	37	1	ROS	101307	1828	BE 46	34.22 N	159 12.98 E	GPS	5120	5121						
49MR0706_1	P01	37	1	BUC	101307	1908	UN 46	34.05 N	159 13.48 E	GPS	5116	5115					1	9.5C
49MR0706_1	P01	37	1	UNK	101307	1928	UN 46	33.90 N	159 13.59 E	GPS	5105	5105						80L THROUGH HULL PUMP FOR R.N.

49MR0706_1	P01	59	1	ROS 102007 0118	BO 46 59.81 N 177 10.60 E GPS	5675	5675	10	5751	5776	36	1-8,22,27	
49MR0706_1	P01	59	1	ROS 102007 0357	EN 46 59.26 N 177 9.09 E GPS	5668	5669						
49MR0706_1	P01	60	2	ROS 102007 0738	BE 47 0.24 N 178 18.28 E GPS	5763	5762						
49MR0706_1	P01	60	2	BUC 102007 0750	UN 47 0.16 N 178 18.07 E GPS	5753	5753				1		9.3C
49MR0706_1	P01	60	2	ROS 102007 0909	BO 46 59.94 N 178 17.48 E GPS	5753	5752	10	5806	5863	36	1-8,12,13,15,23,24,26,27,45	
49MR0706_1	P01	60	2	ROS 102007 1131	EN 46 59.42 N 178 16.20 E GPS	5726	5726						
49MR0706_1	P01	61	2	ROS 102007 1507	BE 47 0.86 N 179 27.17 E GPS	5647	5647						
49MR0706_1	P01	61	2	BUC 102007 1520	UN 47 0.83 N 179 27.18 E GPS	5638	5643				1		9.2C
49MR0706_1	P01	61	2	ROS 102007 1644	BO 47 0.33 N 179 26.57 E GPS	5594	5594	10	5727	5762	35	1-8,15,27,45	
49MR0706_1	P01	61	2	ROS 102007 1907	EN 46 59.40 N 179 25.55 E GPS	5642	5641						
49MR0706_1	F14N	29	1	ROS 102107 0049	BE 47 59.67 N 179 0.11 E GPS	5330	5330						
49MR0706_1	F14N	29	1	BUC 102107 0100	UN 47 59.61 N 178 59.98 E GPS	5319	5318				1		9.3C
49MR0706_1	F14N	29	1	ROS 102107 0215	BO 47 59.51 N 178 59.56 E GPS	5312	5312	10	5332	5412	34	1-8,27	
49MR0706_1	F14N	29	1	ROS 102107 0437	EN 47 59.50 N 178 58.99 E GPS	5346	5345						
49MR0706_1	F14N	28	1	ROS 102107 0726	BE 48 29.85 N 178 59.91 E GPS	5462	5461						
49MR0706_1	F14N	28	1	BUC 102107 0740	UN 48 29.74 N 178 59.91 E GPS	5464	5463				1		8.3C
49MR0706_1	F14N	28	1	UNK 102107 0845	UN 48 29.36 N 178 59.52 E GPS	5532	5532						20L THROUGH HULL PUMP FOR R.N.
49MR0706_1	F14N	28	1	ROS 102107 0859	BO 48 29.27 N 178 59.39 E GPS	5536	5536	11	5566	5600	35	1-8,23,24,26,27	
49MR0706_1	F14N	28	1	ROS 102107 1115	EN 48 28.75 N 178 57.95 E GPS	5518	5517						
49MR0706_1	F14N	27	1	ROS 102107 1356	BE 48 59.68 N 178 59.72 E GPS	4755	4755						
49MR0706_1	F14N	27	1	BUC 102107 1404	UN 48 59.68 N 178 59.64 E GPS	4757	4757				1		8.1C
49MR0706_1		608	1	UNK 102107 1422	UN 48 59.62 N 178 59.55 E GPS	4755	4755						AIR SMPL FOR BVOC #1
49MR0706_1	F14N	27	1	ROS 102107 1512	BO 48 59.60 N 178 59.37 E GPS	4757	4756	9	4779	4840	32	1-8,15,23,24,26,27,45	
49MR0706_1	F14N	27	1	ROS 102107 1721	EN 48 59.21 N 178 58.99 E GPS	4563	4563						
49MR0706_1	F14N	26	1	ROS 102107 1950	BE 49 29.94 N 178 59.60 E GPS	4890	4889						
49MR0706_1	F14N	26	1	BUC 102107 2000	UN 49 29.86 N 178 59.64 E GPS	4889	4888					1,32,34,84,86,87	8.2C
49MR0706_1	F14N	26	1	ROS 102107 2112	BO 49 29.46 N 178 59.49 E GPS	4875	4876	9	4928	4966	34	1-8,15,27,32,34,45,84,86,87	
49MR0706_1	F14N	26	1	ROS 102107 2313	EN 49 28.44 N 178 58.47 E GPS	4918	4918						
49MR0706_1		609	1	UNK 102107 2332	UN 49 30.87 N 178 58.32 E GPS	4872	4873						RAIN SMPL FOR STABLE ISOTOPE #6
49MR0706_1	F14N	25	1	ROS 102207 0144	BE 50 0.38 N 178 59.98 E GPS	4999	4999						
49MR0706_1	F14N	25	1	BUC 102207 0152	UN 50 0.34 N 178 59.96 E GPS	5023	5026				1		8.3C
49MR0706_1	F14N	25	1	ROS 102207 0304	BO 50 0.41 N 178 59.61 E GPS	4981	4981	10	5055	5119	33	1-8,23,24,26,27	
49MR0706_1	F14N	25	1	ROS 102207 0517	EN 50 0.34 N 178 58.96 E GPS	4996	4995						
49MR0706_1	F14N	24	1	ROS 102207 0722	BE 50 14.44 N 179 8.01 E GPS	6808	6807						WITHOUT FLUOROMETER/LADCP
49MR0706_1	F14N	24	1	BUC 102207 0732	UN 50 14.46 N 179 8.08 E GPS	6823	6831				1		7.6C
49MR0706_1	F14N	24	1	UNK 102207 0745	UN 50 14.45 N 179 8.23 E GPS	6809	6807						80L THROUGH HULL PUMP FOR R.N.
49MR0706_1	F14N	24	1	ROS 102207 0859	BO 50 14.66 N 179 9.04 E GPS	6832	6831	-9	6434	6503	36	1-8,22,27	
49MR0706_1	F14N	24	1	ROS 102207 1148	EN 50 14.81 N 179 11.50 E GPS	6743	6742						
49MR0706_1	F14N	23	1	ROS 102207 1339	BE 50 28.43 N 179 16.06 E GPS	7014	7015						WITHOUT FLUOROMETER/LADCP
49MR0706_1	F14N	23	1	BUC 102207 1346	UN 50 28.47 N 179 16.10 E GPS	7004	7005				1		7.4C
49MR0706_1	F14N	23	1	ROS 102207 1515	BO 50 28.96 N 179 16.53 E GPS	6967	6967	-9	6426	6500	36	1-8,12,13,23,24,26,27,85	
49MR0706_1	F14N	23	1	ROS 102207 1817	EN 50 29.55 N 179 18.23 E GPS	6919	6917						
49MR0706_1	F14N	22	1	ROS 102207 2051	BE 50 42.00 N 179 25.09 E GPS	4549	4550						
49MR0706_1	F14N	22	1	BUC 102207 2101	UN 50 42.04 N 179 25.13 E GPS	4550	4551				1		6.6C
49MR0706_1	F14N	22	1	ROS 102207 2202	BO 50 42.28 N 179 25.74 E GPS	4560	4561	9	4601	4619	33	1-8,27,85	
49MR0706_1	F14N	22	1	ROS 102207 2354	EN 50 42.63 N 179 26.16 E GPS	4567	4568						
49MR0706_1	F14N	21	1	ROS 102307 0158	BE 50 56.06 N 179 34.22 E GPS	4014	4013						
49MR0706_1	F14N	21	1	BUC 102307 0206	UN 50 56.15 N 179 34.19 E GPS	4021	4021				1		6.2C
49MR0706_1	F14N	21	1	ROS 102307 0305	BO 50 56.50 N 179 34.15 E GPS	3997	3997	10	4030	4065	29	1-8,27	
49MR0706_1	F14N	21	1	ROS 102307 0458	EN 50 57.23 N 179 35.02 E GPS	3956	3957						
49MR0706_1	F14N	20	1	ROS 102307 0655	BE 51 9.87 N 179 44.34 E GPS	2621	2622						

49MR0706_1	P14N	20	1	BUC 102307 0705	UN 51 10.03 N 179 44.36 E GPS	2532	2532				1	6.1C
49MR0706_1	P14N	20	1	UNK 102307 0713	UN 51 10.15 N 179 44.37 E GPS	2436	2437					20L THROUGH HULL PUMP FOR R.N.
49MR0706_1	P14N	20	1	ROS 102307 0740	BO 51 10.45 N 179 44.67 E GPS	2339	2340	10	2430	2392	21	1-8,23,24,26,27
49MR0706_1	P14N	20	1	ROS 102307 0852	EN 51 11.20 N 179 45.30 E GPS	2230	2231					
49MR0706_1	P14N	19	1	ROS 102307 1048	BE 51 24.02 N 179 53.97 E GPS	1526	1526					
49MR0706_1	P14N	19	1	BUC 102307 1057	UN 51 24.04 N 179 54.11 E GPS	1550	1550				1	6.1C
49MR0706_1	P14N	19	1	ROS 102307 1120	BO 51 24.09 N 179 54.51 E GPS	1615	1616	10	1598	1597	17	1-8,23,24,26,27
49MR0706_1		610	1	UNK 102307 1201	UN 51 24.09 N 179 55.42 E GPS	1697	1697					AIR SMPL FOR BVOC #2
49MR0706_1		611	1	UNK 102307 1210	UN 51 24.12 N 179 55.47 E GPS	1703	1703					RAIN SMPL FOR STABLE ISOTOPE #7
49MR0706_1	P14N	19	1	ROS 102307 1214	EN 51 24.14 N 179 55.52 E GPS	1703	1703					
49MR0706_1	P14N	18	1	ROS 102307 1413	BE 51 37.68 N 179 56.42 W GPS	1890	1890					
49MR0706_1	P14N	18	1	BUC 102307 1419	UN 51 37.66 N 179 56.42 W GPS	1891	1892				1	6.5C
49MR0706_1	P14N	18	1	ROS 102307 1447	BO 51 37.68 N 179 56.29 W GPS	1890	1890	10	1891	1902	19	1-8,27
49MR0706_1	P14N	18	1	ROS 102307 1553	EN 51 37.50 N 179 55.82 W GPS	1895	1895					
49MR0706_1	P14N	17	1	ROS 102307 1758	BE 51 51.50 N 179 47.13 W GPS	2114	2112					
49MR0706_1	P14N	17	1	BUC 102307 1807	UN 51 51.49 N 179 47.04 W GPS	2104	2102				1, 32, 34, 84, 86, 87	6.6C
49MR0706_1	P14N	17	1	ROS 102307 1837	BO 51 51.43 N 179 46.78 W GPS	2084	2083	9	2123	2126	20	1-8,23,24,26,27,32,34,84,86,87
49MR0706_1	P14N	17	1	ROS 102307 1943	EN 51 51.09 N 179 46.57 W GPS	2051	2049					
49MR0706_1	P14N	16	1	ROS 102307 2149	BE 52 4.14 N 179 23.15 W GPS	2939	2939					
49MR0706_1	P14N	16	1	BUC 102307 2157	UN 52 4.20 N 179 23.10 W GPS	2933	2932				1	6.3C
49MR0706_1	P14N	16	1	UNK 102307 2208	UN 52 4.19 N 179 23.07 W GPS	2954	2953					20L THROUGH HULL PUMP FOR R.N.
49MR0706_1	P14N	16	1	ROS 102307 2239	BO 52 4.14 N 179 22.94 W GPS	2979	2979	12	2950	2975	24	1-8,27
49MR0706_1	P14N	16	1	ROS 102307 2353	EN 52 4.15 N 179 22.76 W GPS	2978	2977					
49MR0706_1	P14N	15	1	ROS 102407 0159	BE 52 15.42 N 178 59.93 W GPS	3304	3304					
49MR0706_1	P14N	15	1	BUC 102407 0206	UN 52 15.47 N 178 59.90 W GPS	3304	3304				1	6.6C
49MR0706_1	P14N	15	1	ROS 102407 0254	BO 52 15.68 N 178 59.54 W GPS	3308	3308	9	3333	3348	26	1-8,23,24,26,27
49MR0706_1	P14N	15	1	ROS 102407 0426	EN 52 16.14 N 178 58.52 W GPS	3322	3322					
49MR0706_1	P14N	15	1	FLT 102407 0434	DE 52 16.13 N 178 58.20 W GPS	3331	3330					ARGO #3268/ID33318
49MR0706_1	P14N	14	1	ROS 102407 0631	BE 52 30.26 N 178 46.11 W GPS	3472	3470					
49MR0706_1	P14N	14	1	BUC 102407 0640	UN 52 30.33 N 178 45.98 W GPS	3470	3469				1	6.6C
49MR0706_1	P14N	14	1	ROS 102407 0729	BO 52 30.47 N 178 45.35 W GPS	3478	3477	10	3521	3515	26	1-8,15,27,45
49MR0706_1	P14N	14	1	ROS 102407 0856	EN 52 30.77 N 178 44.88 W GPS	3485	3484					
49MR0706_1	P14N	13	1	ROS 102407 1111	BE 53 0.04 N 178 35.62 W GPS	3713	3713					
49MR0706_1	P14N	13	1	BUC 102407 1119	UN 53 0.09 N 178 35.45 W GPS	3715	3715				1	6.8C
49MR0706_1	P14N	13	1	ROS 102407 1211	BO 53 0.21 N 178 34.62 W GPS	3718	3718	9	3763	3766	28	1-8,15,23,24,26,27,45
49MR0706_1	P14N	13	1	ROS 102407 1345	EN 53 0.34 N 178 33.18 W GPS	3718	3719					
49MR0706_1	P14N	12	1	ROS 102407 1606	BE 53 29.87 N 178 15.12 W GPS	3773	3772					
49MR0706_1	P14N	12	1	BUC 102407 1614	UN 53 29.89 N 178 14.94 W GPS	3771	3770				1	6.7C
49MR0706_1	P14N	12	1	UNK 102407 1645	UN 53 29.69 N 178 14.43 W GPS	3771	3770					80L THROUGH HULL PUMP FOR R.N.
49MR0706_1	P14N	12	1	ROS 102407 1708	BO 53 29.54 N 178 14.25 W GPS	3769	3767	10	3826	3825	36	1-8,22,27
49MR0706_1	P14N	12	1	ROS 102407 1846	EN 53 29.26 N 178 13.94 W GPS	3771	3770					
49MR0706_1	P14N	12	1	FLT 102407 1855	DE 53 29.33 N 178 14.01 W GPS	3771	3769					ARGO #3264/ID33314
49MR0706_1		612	1	UNK 102407 1938	UN 53 38.00 N 178 8.16 W GPS	3789	3788					RAIN SMPL FOR STABLE ISOTOPE #8
49MR0706_1	P14N	11	1	ROS 102407 2120	BE 54 0.02 N 177 54.19 W GPS	3801	3802					
49MR0706_1	P14N	11	1	BUC 102407 2129	UN 54 0.01 N 177 54.01 W GPS	3800	3800				1	6.5C
49MR0706_1		613	1	UNK 102407 2142	UN 53 59.93 N 177 53.84 W GPS	3801	3802					AIR SMPL FOR BVOC #3
49MR0706_1	P14N	11	1	ROS 102407 2222	BO 53 59.67 N 177 53.35 W GPS	3800	3800	9	3876	3852	36	1-8,12,13,23,24,26,27,40,43
49MR0706_1	P14N	11	1	ROS 102407 2355	EN 53 59.55 N 177 52.97 W GPS	3802	3801					
49MR0706_1	P14N	10	1	ROS 102507 0225	BE 54 29.65 N 177 33.67 W GPS	3792	3791					
49MR0706_1	P14N	10	1	BUC 102507 0232	UN 54 29.61 N 177 33.59 W GPS	3792	3791				1	6.1C
49MR0706_1	P14N	10	1	ROS 102507 0326	BO 54 29.59 N 177 33.34 W GPS	3792	3791	10	3797	3842	28	1-8,27

49MR0706_1	P14N	10	1	ROS 102507 0507	EN 54 29.78 N 177 33.13 W GPS	3792	3791												
49MR0706_1	P14N	9	1	ROS 102507 0738	BE 54 59.95 N 177 11.93 W GPS	3776	3775												REPLACED BTL #10
49MR0706_1	P14N	9	1	BUC 102507 0747	UN 54 59.99 N 177 11.76 W GPS	3777	3775												6.0C
49MR0706_1	P14N	9	1	UNK 102507 0756	UN 55 0.00 N 177 11.55 W GPS	3778	3777												20L THROUGH HULL PUMP FOR R.N.
49MR0706_1	P14N	9	1	ROS 102507 0840	BO 54 59.85 N 177 10.88 W GPS	3778	3778	9	3830	3831									28 1-8,23,24,26,27
49MR0706_1	P14N	9	1	ROS 102507 1009	EN 54 59.63 N 177 9.33 W GPS	3780	3779												
49MR0706_1	P14N	9	1	FLT 102507 1018	DE 54 59.59 N 177 9.45 W GPS	3779	3777												ARGO #3265/ID33315
49MR0706_1	P14N	8	1	ROS 102507 1240	BE 55 29.81 N 176 50.52 W GPS	3753	3752												
49MR0706_1	P14N	8	1	BUC 102507 1249	UN 55 29.80 N 176 50.49 W GPS	3752	3754												6.0C
49MR0706_1	P14N	8	1	ROS 102507 1342	BO 55 29.89 N 176 50.29 W GPS	3753	3753	10	3763	3806									27 1-8,27
49MR0706_1	P14N	8	1	ROS 102507 1520	EN 55 30.07 N 176 50.39 W GPS	3752	3752												
49MR0706_1	P14N	7	1	ROS 102507 1751	BE 56 0.06 N 176 29.91 W GPS	3716	3716												REPLACED BTL #10
49MR0706_1	P14N	7	1	BUC 102507 1801	UN 56 0.03 N 176 29.74 W GPS	3718	3717												5.7C
49MR0706_1	P14N	7	1	ROS 102507 1856	BO 55 59.70 N 176 28.94 W GPS	3716	3716	10	3784	3770									1, 32, 34, 84, 86, 87
49MR0706_1	P14N	7	1	ROS 102507 2028	EN 55 58.97 N 176 27.61 W GPS	3716	3716												27 1-8,23,24,26,27,32,34,84,86,87
49MR0706_1	P14N	6	1	ROS 102507 2311	BE 56 30.15 N 176 5.68 W GPS	3674	3673												
49MR0706_1	P14N	6	1	BUC 102507 2322	UN 56 30.07 N 176 5.64 W GPS	3675	3674												1
49MR0706_1		614	1	UNK 102507 2330	UN 56 30.02 N 176 5.65 W GPS	3674	3674												5.4C
49MR0706_1	P14N	6	1	UNK 102507 2330	UN 56 30.01 N 176 5.65 W GPS	3674	3674												AIR SMPL FOR BVOC #4
49MR0706_1	P14N	6	1	ROS 102607 0012	BO 56 29.72 N 176 5.64 W GPS	3675	3676	10	3697	3726									80L THROUGH HULL PUMP FOR R.N.
49MR0706_1	P14N	6	1	ROS 102607 0146	EN 56 29.05 N 176 5.54 W GPS	3675	3676												
49MR0706_1	P14N	6	1	FLT 102607 0155	DE 56 29.22 N 176 5.71 W GPS	3672	3672												ARGO #3260/ID33306
49MR0706_1	P14N	5	1	ROS 102607 0455	BE 56 59.04 N 175 39.80 W GPS	3481	3479												
49MR0706_1	P14N	5	1	BUC 102607 0510	UN 56 58.90 N 175 39.97 W GPS	3485	3484												1
49MR0706_1		615	1	UNK 102607 0537	UN 56 58.79 N 175 40.31 W GPS	3484	3483												5.7C
49MR0706_1	P14N	5	1	ROS 102607 0559	BO 56 58.74 N 175 40.39 W GPS	3483	3482	8	3498	3529									RAIN SMPL FOR STABLE ISOTOPE #9
49MR0706_1	P14N	5	1	ROS 102607 0730	EN 56 58.43 N 175 41.12 W GPS	3481	3480												26 1-8,12,13,23,24,26,27
49MR0706_1	P14N	1	1	ROS 102707 0006	BE 59 0.11 N 173 59.67 W GPS	124	123												
49MR0706_1	P14N	1	1	BUC 102707 0007	UN 59 0.11 N 173 59.69 W GPS	124	123												1
49MR0706_1	P14N	1	1	UNK 102707 0007	UN 59 0.12 N 173 59.70 W GPS	124	123												5.7C
49MR0706_1	P14N	1	1	ROS 102707 0013	BO 59 0.11 N 173 59.74 W GPS	123	123	-9	110	114									20L THROUGH HULL PUMP FOR R.N.
49MR0706_1	P14N	1	1	ROS 102707 0023	EN 59 0.08 N 173 59.80 W GPS	125	123												ALTIMETER NOT WORK
49MR0706_1		616	1	UNK 102707 0023	UN 59 0.08 N 173 59.80 W GPS	125	123												
49MR0706_1		617	1	UNK 102707 0256	UN 58 29.96 N 174 24.91 W GPS	147	148												AIR SMPL FOR BVOC #5
49MR0706_1	P14N	2	1	ROS 102707 0257	BE 58 29.95 N 174 24.94 W GPS	148	149												RAIN SMPL FOR STABLE ISOTOPE #10
49MR0706_1	P14N	2	1	BUC 102707 0300	UN 58 29.93 N 174 24.98 W GPS	146	146												1
49MR0706_1	P14N	2	1	ROS 102707 0304	BO 58 29.90 N 174 25.03 W GPS	147	147	-9	134	138									5.4C
49MR0706_1	P14N	2	1	ROS 102707 0311	EN 58 29.90 N 174 25.19 W GPS	146	146												ALTIMETER NOT WORK
49MR0706_1	P14N	3	1	ROS 102707 0541	BE 58 0.31 N 174 51.62 W GPS	3014	3014												
49MR0706_1	P14N	3	1	BUC 102707 0552	UN 58 0.22 N 174 51.80 W GPS	3012	3012												1
49MR0706_1	P14N	3	1	ROS 102707 0633	BO 58 0.02 N 174 52.33 W GPS	3003	3002	10	3027	3039									5.8C
49MR0706_1	P14N	3	1	ROS 102707 0752	EN 57 59.68 N 174 53.51 W GPS	2980	2979												25 1-8,23,24,26,27
49MR0706_1	P14N	3	1	FLT 102707 0801	DE 57 59.70 N 174 53.87 W GPS	2973	2974												ARGO #3261/ID33307
49MR0706_1	P14N	4	1	ROS 102707 1022	BE 57 29.91 N 175 14.83 W GPS	3460	3460												
49MR0706_1	P14N	4	1	BUC 102707 1030	UN 57 29.85 N 175 14.86 W GPS	3459	3459												1
49MR0706_1	P14N	4	1	UNK 102707 1041	UN 57 29.80 N 175 14.93 W GPS	3460	3460												5.7C
49MR0706_1	P14N	4	1	ROS 102707 1119	BO 57 29.69 N 175 15.32 W GPS	3463	3464	9	3462	3510									80L THROUGH HULL PUMP FOR R.N.
49MR0706_1	P14N	4	1	ROS 102707 1245	EN 57 29.36 N 175 16.11 W GPS	3468	3468												
49MR0706_1		618	1	UNK 102807 2056	UN 50 40.92 N 179 44.67 E GPS	4978	4978												RAIN SMPL FOR STABLE ISOTOPE #11
49MR0706_1		619	1	UNK 102807 2223	BE 50 23.74 N 179 37.89 E GPS	7154	7154												RELEASING EXCESS TWIST OF CTD CABLE AFTER CUTTING OF THE CABLE (400M)

49MR0706_1	619	1	UNK 102907 0310	EN 50 23.30 N 179 38.47 E GPS	7294	7294						WOUT 7000M, WEIGHT OF 300KG WITH COMPASS/TILT METER
49MR0706_1	620	1	UNK 102907 0352	UN 50 16.37 N 179 37.62 E GPS	7286	7286						RAIN SMPL FOR STABLE ISOTOPE #12
49MR0706_1	621	1	UNK 102907 0807	UN 49 15.89 N 179 21.89 E GPS	4826	4826						RAIN SMPL FOR STABLE ISOTOPE #13
49MR0706_1	P14N	30	1	ROS 102907 1607	BE 47 29.66 N 178 59.36 E GPS	4961	4962					REPLACED PRI AND SEC TMP SENSORS
49MR0706_1	P14N	30	1	BUC 102907 1628	UN 47 29.70 N 178 58.98 E GPS	4895	4894					8.7C
49MR0706_1	P14N	30	1	ROS 102907 1735	BO 47 29.78 N 178 59.41 E GPS	4973	4972	9	4984	5042		1,32,34,84,86,87 35 1-8,15,27,32,34,45,84,86,87
49MR0706_1	P14N	30	1	ROS 102907 1941	EN 47 29.26 N 179 0.45 E GPS	4972	4970					
49MR0706_1	P14N	X01	1	ROS 102907 2252	BE 47 0.57 N 179 27.09 E GPS	5634	5636					
49MR0706_1	P14N	X01	1	BUC 102907 2314	UN 47 0.27 N 179 27.27 E GPS	5680	5680					8.7C
49MR0706_1	P14N	X01	1	ROS 103007 0041	BO 46 58.99 N 179 27.20 E GPS	5677	5679	11	5858	5718		36 1-8,12,13,15,23,24,26,27,40,42,43,45
49MR0706_1	P14N	X01	1	ROS 103007 0311	EN 46 57.35 N 179 26.29 E GPS	5447	5450					
49MR0706_1	P14N	32	1	ROS 103007 0554	BE 46 29.88 N 179 0.31 E GPS	5638	5640					
49MR0706_1	P14N	32	1	BUC 103007 0610	UN 46 29.72 N 179 0.27 E GPS	5598	5598					9.1C
49MR0706_1	P14N	622	1	UNK 103007 0613	UN 46 29.70 N 179 0.28 E GPS	5647	5645					AIR SMPL FOR BVOC #6 80L THROUGH HULL PUMP FOR R.N.
49MR0706_1	P14N	32	1	UNK 103007 0626	UN 46 29.60 N 179 0.25 E GPS	5621	5621					
49MR0706_1	P14N	32	1	ROS 103007 0725	BO 46 29.30 N 179 0.36 E GPS	5637	5636	9	5636	5709		36 1-8,22,27
49MR0706_1	P14N	32	1	ROS 103007 0941	EN 46 29.57 N 179 0.88 E GPS	5608	-9					UNC DEPTH QUESTIONABLE
49MR0706_1	P14N	33	1	ROS 103007 1223	BE 45 59.86 N 179 0.36 E GPS	5739	5742					
49MR0706_1	P14N	33	1	BUC 103007 1239	UN 45 59.89 N 179 0.53 E GPS	5719	5719					9.6C
49MR0706_1	P14N	33	1	ROS 103007 1358	BO 45 59.53 N 179 1.09 E GPS	5721	5723	10	5760	5835		36 1-8,27
49MR0706_1	P14N	33	1	ROS 103007 1627	EN 45 58.79 N 179 2.09 E GPS	5733	5733					
49MR0706_1	P14N	34	1	ROS 103007 1851	BE 45 30.08 N 179 0.45 E GPS	5811	5812					REPLACED SEC TMP SENSOR
49MR0706_1	P14N	34	1	BUC 103007 1906	UN 45 29.96 N 179 0.81 E GPS	5810	5811					11.3C
49MR0706_1	P14N	34	1	ROS 103007 2029	BO 45 29.83 N 179 1.68 E GPS	5794	5796	9	5866	5928		36 1-8,23,24,26,27,85
49MR0706_1	P14N	34	1	ROS 103007 2249	EN 45 29.55 N 179 2.44 E GPS	5764	5767					
49MR0706_1	P14N	35	1	ROS 103107 0410	BE 45 0.73 N 179 0.27 E GPS	5773	5773					
49MR0706_1	P14N	35	1	BUC 103107 0425	UN 45 0.78 N 179 0.42 E GPS	5792	5794					11.3C
49MR0706_1	P14N	35	1	ROS 103107 0546	BO 45 0.64 N 179 0.85 E GPS	5776	5775	11	5844	5929		36 1-8,27,85
49MR0706_1	P14N	35	1	ROS 103107 0808	EN 45 0.39 N 179 1.84 E GPS	5768	5768					
49MR0706_1	P14N	623	1	UNK 103107 0917	UN 44 47.66 N 179 1.85 E GPS	5658	5657					RAIN SMPL FOR STABLE ISOTOPE #14
49MR0706_1	P14N	36	1	ROS 103107 1043	BE 44 30.03 N 179 0.96 E GPS	5678	5677					
49MR0706_1	P14N	36	1	BUC 103107 1059	UN 44 29.86 N 179 1.06 E GPS	5688	5685					11.6C
49MR0706_1	P14N	36	1	UNK 103107 1112	UN 44 29.78 N 179 0.95 E GPS	5702	5699					80L THROUGH HULL PUMP FOR R.N.
49MR0706_1	P14N	36	1	ROS 103107 1220	BO 44 29.59 N 179 0.55 E GPS	5749	5747	10	5763	5819		36 1-8,22,27
49MR0706_1	P14N	36	1	ROS 103107 1447	EN 44 29.21 N 178 59.48 E GPS	5751	5749					
49MR0706_1	P14N	37	1	ROS 103107 1707	BE 43 59.80 N 178 59.59 E GPS	5639	5638					
49MR0706_1	P14N	37	1	BUC 103107 1719	UN 43 59.68 N 178 59.40 E GPS	5654	5653					1,32,34,84,86,87
49MR0706_1	P14N	624	1	UNK 103107 1733	UN 43 59.66 N 178 59.30 E GPS	5653	5652					11.0C
49MR0706_1	P14N	37	1	ROS 103107 1836	BO 43 59.73 N 178 58.60 E GPS	5651	5650	10	5716	5755		36 1-8,15,23,24,26,27,32,34,45,84,86,87
49MR0706_1	P14N	37	1	ROS 103107 2052	EN 43 59.36 N 178 57.39 E GPS	5679	5679					
49MR0706_1	P14N	38	1	ROS 103107 2319	BE 43 30.03 N 179 0.07 E GPS	5815	5817					
49MR0706_1	P14N	38	1	BUC 103107 2327	UN 43 30.09 N 179 0.09 E GPS	5814	5815					11.6C
49MR0706_1	P14N	38	1	ROS 110107 0051	BO 43 29.94 N 179 0.76 E GPS	5810	5811	11	5864	5923		36 1-8,15,27,45
49MR0706_1	P14N	38	1	ROS 110107 0318	EN 43 29.17 N 179 2.21 E GPS	5747	5747					
49MR0706_1	P14N	39	1	ROS 110107 0537	BE 42 58.70 N 179 0.12 E GPS	5636	5637					
49MR0706_1	P14N	39	1	BUC 110107 0546	UN 42 58.60 N 179 0.23 E GPS	5649	5651					13.1C
49MR0706_1	P14N	39	1	UNK 110107 0554	UN 42 58.56 N 179 0.30 E GPS	5645	5646					20L THROUGH HULL PUMP FOR R.N.
49MR0706_1	P14N	39	1	ROS 110107 0706	BO 42 57.96 N 179 0.08 E GPS	5655	5656	10	5746	5761		36 1-8,23,24,26,27
49MR0706_1	P14N	39	1	ROS 110107 0927	EN 42 57.26 N 178 59.11 E GPS	5686	5689					
49MR0706_1	P14N	40	1	ROS 110107 1132	BE 42 28.89 N 179 0.58 E GPS	5809	5809					

49MR0706_1	P14N	71	1	ROS 110807 2205	BO 27 0.28 N 179 0.67 E GPS	5436	5436	8	5474	5519	34	1-8,15,27,45	#31 MISS FIRE
49MR0706_1	P14N	71	1	ROS 110907 0014	EN 26 59.97 N 179 1.72 E GPS	5451	5450						
49MR0706_1	P14N	71	1	FLT 110907 0021	DE 26 59.79 N 179 1.77 E GPS	5448	5448						ARGO #3328/ID75740
49MR0706_1	P14N	72	1	ROS 110907 0229	BE 26 29.96 N 179 0.00 E GPS	5555	5556						
49MR0706_1	P14N	72	1	BUC 110907 0238	UN 26 29.92 N 179 0.00 E GPS	5554	5553				1		26.6C
49MR0706_1	P14N	72	1	UNK 110907 0245	UN 26 29.90 N 179 0.01 E GPS	5558	5558						80L THROUGH HULL PUMP FOR R.N.
49MR0706_1		637	1	UNK 110907 0251	UN 26 29.88 N 179 0.01 E GPS	5555	5555						AIR SMPL FOR BVOC #14
49MR0706_1	P14N	72	1	ROS 110907 0356	BO 26 29.73 N 179 0.11 E GPS	5567	5567	9	5571	5651	36	1-8,22,27	
49MR0706_1	P14N	72	1	ROS 110907 0609	EN 26 29.64 N 179 0.19 E GPS	5567	5567						
49MR0706_1	P14N	73	1	ROS 110907 0824	BE 25 59.87 N 179 0.22 E GPS	5500	5499						
49MR0706_1	P14N	73	1	BUC 110907 0831	UN 25 59.87 N 179 0.17 E GPS	5509	5508				1		26.6C
49MR0706_1	P14N	73	1	ROS 110907 0947	BO 25 59.63 N 178 59.85 E GPS	5526	5525	10	5528	5591	35	1-8,23,24,26,27	
49MR0706_1	P14N	73	1	ROS 110907 1156	EN 25 59.38 N 178 59.31 E GPS	5546	5546						
49MR0706_1		638	1	UNK 110907 1206	BE 25 59.83 N 178 59.21 E GPS	5548	5547						3-AXIS MAGNETOMETER CALIBRATION
49MR0706_1		638	1	UNK 110907 1224	EN 26 0.41 N 178 59.29 E GPS	5524	5524						
49MR0706_1	P14N	74	1	ROS 111007 1605	BE 25 29.64 N 179 0.29 E GPS	5701	5701						REPLACED SEC TMP SENSOR
49MR0706_1	P14N	74	1	BUC 111007 1613	UN 25 29.66 N 179 0.27 E GPS	5707	5707					1,32,34,84,86,87	26.7C, PLANKTON NET
49MR0706_1	P14N	74	1	ROS 111007 1733	BO 25 29.81 N 179 0.24 E GPS	5704	5703	-9	5536				PRI AND SEC CND SENSORS BROKE
49MR0706_1	P14N	74	1	ROS 111007 1859	EN 25 29.82 N 179 0.17 E GPS	5704	5703						QUITTED THIS CAST
49MR0706_1	P14N	74	2	ROS 111007 2002	BE 25 29.72 N 179 0.38 E GPS	5700	5700						REPLACED PRI CND SENSOR, REMOVED SEC TMP AND CND SENSORS
49MR0706_1	P14N	74	2	ROS 111007 2130	BO 25 30.06 N 179 0.33 E GPS	5722	5720	10	5726	5799	35	1-8,27	
49MR0706_1	P14N	74	2	ROS 111007 2345	EN 25 30.53 N 179 0.13 E GPS	5717	5717						
49MR0706_1	P14N	75	1	ROS 111107 0207	BE 24 59.70 N 179 0.21 E GPS	5579	5579						ATTACHED SEC TMP SENSOR
49MR0706_1	P14N	75	1	BUC 111107 0215	UN 24 59.77 N 179 0.20 E GPS	5571	5571				1		27.0C
49MR0706_1	P14N	75	1	ROS 111107 0336	BO 24 59.99 N 179 0.89 E GPS	5701	5701	10	5689	5700	35	1-8,23,24,26,27	
49MR0706_1	P14N	75	1	ROS 111107 0547	EN 25 0.33 N 179 1.57 E GPS	5710	5710						
49MR0706_1	P14N	75	1	FLT 111107 0554	DE 25 0.27 N 179 1.59 E GPS	5715	5715						ARGO #3341/ID75753
49MR0706_1	P14N	76	1	ROS 111107 0811	BE 24 30.00 N 179 0.02 E GPS	5722	5724						
49MR0706_1	P14N	76	1	BUC 111107 0819	UN 24 29.99 N 179 0.06 E GPS	5723	5724				1		27.1C
49MR0706_1	P14N	76	1	UNK 111107 0827	UN 24 30.05 N 179 0.08 E GPS	5722	5723						80L THROUGH HULL PUMP FOR R.N.
49MR0706_1	P14N	76	1	ROS 111107 0939	BO 24 29.97 N 179 0.07 E GPS	5721	5722	10	5734	5822	36	1-8,22,27	
49MR0706_1	P14N	76	1	ROS 111107 1154	EN 24 30.05 N 178 59.99 E GPS	5726	5729						
49MR0706_1	P14N	77	1	ROS 111107 1412	BE 24 0.05 N 178 59.85 E GPS	5739	5739						
49MR0706_1	P14N	77	1	BUC 111107 1421	UN 24 0.07 N 178 59.79 E GPS	5741	5740				1		27.0C
49MR0706_1		639	1	UNK 111107 1435	UN 24 0.06 N 178 59.68 E GPS	5741	5741						AIR SMPL FOR BVOC #15
49MR0706_1	P14N	77	1	ROS 111107 1544	BO 24 0.47 N 178 59.53 E GPS	5744	5743	10	5791	5838	36	1-8,12,13,23,24,26,27,32,34,40,42,43,84,86,87	#27 MISS TRIP
49MR0706_1	P14N	77	2	BUC 111107 1717	UN 24 1.01 N 178 59.36 E GPS	5741	5741					32,34,84,86,87	PLANKTON NET
49MR0706_1	P14N	77	1	ROS 111107 1800	EN 24 1.30 N 178 59.22 E GPS	5743	5742						
49MR0706_1	P14N	78	1	ROS 111107 2030	BE 23 30.10 N 178 59.87 E GPS	5737	5737						
49MR0706_1	P14N	78	1	BUC 111107 2039	UN 23 30.11 N 178 59.79 E GPS	5732	5732				1		27.1C
49MR0706_1	P14N	78	1	ROS 111107 2159	BO 23 30.32 N 178 59.50 E GPS	5738	5738	9	5754	5831	36	1-8,15,27,45	
49MR0706_1	P14N	78	1	ROS 111207 0015	EN 23 30.51 N 178 59.21 E GPS	5742	5741						
49MR0706_1	P14N	79	1	ROS 111207 0239	BE 23 0.19 N 178 59.86 E GPS	5706	5707						
49MR0706_1	P14N	79	1	BUC 111207 0247	UN 23 0.21 N 178 59.82 E GPS	5710	5710				1		27.3C
49MR0706_1	P14N	79	1	UNK 111207 0254	UN 23 0.20 N 178 59.78 E GPS	5711	5711						20L THROUGH HULL PUMP FOR R.N.
49MR0706_1	P14N	79	1	ROS 111207 0408	BO 23 0.16 N 178 59.64 E GPS	5724	5723	9	5723	5810	36	1-8,15,23,24,26,27,45	
49MR0706_1	P14N	79	1	ROS 111207 0623	EN 23 0.05 N 178 59.04 E GPS	5718	5719						
49MR0706_1	P14N	80	1	ROS 111207 0848	BE 22 30.56 N 179 0.21 E GPS	5360	5360						ATTACHED SEC CND SENSOR
49MR0706_1	P14N	80	1	BUC 111207 0857	UN 22 30.59 N 179 0.14 E GPS	5363	5363				1		27.1C
49MR0706_1	P14N	80	1	ROS 111207 1013	BO 22 31.00 N 178 59.78 E GPS	5356	5356	9	5415	5445	34	1-8,27,28	

49MR0706_2	F14N	118	1	ROS 112507 2220	BE 06 14.48 N 178 59.79 E GPS	5782	5782						
49MR0706_2	F14N	118	1	BUC 112507 2228	UN 06 14.48 N 178 59.80 E GPS	5780	5779				1		28.3C
49MR0706_2	F14N	118	1	ROS 112507 2349	BO 06 14.36 N 178 59.88 E GPS	5791	5793	9	5790	5872	36	1-8,27	
49MR0706_2		655	1	UNK 112607 0032	UN 06 14.39 N 178 59.94 E GPS	5774	5773						RAIN SMPL FOR STABLE ISOTOPE #29
49MR0706_2	F14N	118	1	ROS 112607 0219	EN 06 14.39 N 179 0.33 E GPS	5791	5792						
49MR0706_2	F14N	119	1	ROS 112607 0347	BE 06 0.08 N 178 59.64 E GPS	5798	5796						
49MR0706_2	F14N	119	1	BUC 112607 0355	UN 06 0.11 N 178 59.62 E GPS	5797	5798				1		28.3C
49MR0706_2	F14N	119	1	UNK 112607 0434	UN 06 0.33 N 178 59.77 E GPS	5797	5796						20L THROUGH HULL PUMP FOR R.N.
49MR0706_2	F14N	119	1	ROS 112607 0516	BO 06 0.41 N 178 59.76 E GPS	5799	5799	10	5819	5893	36	1-8,23,24,26,27	
49MR0706_2	F14N	119	1	ROS 112607 0736	EN 06 0.90 N 178 59.71 E GPS	5791	5790						
49MR0706_2	F14N	120	1	ROS 112607 0928	BE 05 44.94 N 178 59.95 E GPS	5683	5684						
49MR0706_2	F14N	120	1	BUC 112607 0936	UN 05 45.02 N 178 59.99 E GPS	5687	5688				1		28.3C
49MR0706_2	F14N	120	1	ROS 112607 1055	BO 05 45.18 N 179 0.19 E GPS	5671	5671	8	5690	5770	36	1-8,27	
49MR0706_2	F14N	120	1	ROS 112607 1316	EN 05 45.24 N 179 0.36 E GPS	5661	5661						
49MR0706_2	F14N	121	1	ROS 112607 1450	BE 05 29.58 N 179 0.02 E GPS	5764	5764						
49MR0706_2	F14N	121	1	BUC 112607 1458	UN 05 29.58 N 179 0.03 E GPS	5758	5757				1		28.2C
49MR0706_2	F14N	121	1	ROS 112607 1619	BO 05 29.49 N 178 59.93 E GPS	5742	5742	7	5779	5859	36	1-8,23,24,26,27	#2 EXTRA FOR CFC
49MR0706_2	F14N	121	2	BUC 112607 1725	UN 05 29.37 N 178 59.93 E GPS	5739	5739					34,86,87	PLANKTON NET
49MR0706_2	F14N	121	1	ROS 112607 1841	EN 05 29.41 N 178 59.74 E GPS	5731	5731						
49MR0706_2	F14N	122	1	ROS 112607 2048	BE 05 14.48 N 178 59.78 E GPS	5692	5694						
49MR0706_2	F14N	122	1	BUC 112607 2057	UN 05 14.48 N 178 59.71 E GPS	5692	5693				1		28.3C
49MR0706_2	F14N	122	1	ROS 112607 2215	BO 05 14.79 N 178 59.63 E GPS	5704	5705	9	5721	5791	36	1-8,27,28	#2 EXTRA FOR CFC
49MR0706_2	F14N	122	1	ROS 112707 0031	EN 05 15.25 N 178 59.47 E GPS	5729	5729						
49MR0706_2	F14N	123	1	ROS 112707 0300	BE 04 59.48 N 178 59.72 E GPS	6098	6097						
49MR0706_2	F14N	123	1	BUC 112707 0308	UN 04 59.49 N 178 59.66 E GPS	6117	6117				1		28.4C
49MR0706_2	F14N	123	1	ROS 112707 0434	BO 04 59.79 N 178 59.68 E GPS	6128	6127	9	6133	6213	36	1-8,23,24,26,27	WITHOUT FLUOROMETER
49MR0706_2	F14N	123	1	ROS 112707 0704	EN 04 59.86 N 178 59.34 E GPS	6122	6120						
49MR0706_2	F14N	124	1	ROS 112707 0907	BE 04 44.67 N 179 0.00 E GPS	5854	5854						
49MR0706_2	F14N	124	1	BUC 112707 0916	UN 04 44.68 N 178 59.99 E GPS	5852	5852				1		27.9C
49MR0706_2	F14N	124	1	UNK 112707 0921	UN 04 44.70 N 178 59.99 E GPS	5856	5856						80L THROUGH HULL PUMP FOR R.N.
49MR0706_2	F14N	124	1	ROS 112707 1036	BO 04 44.92 N 179 0.08 E GPS	5857	5857	9	5873	5952	36	1-8,22,27	
49MR0706_2	F14N	124	1	ROS 112707 1300	EN 04 45.27 N 179 0.27 E GPS	5881	5880						
49MR0706_2	F14N	125	1	ROS 112707 1440	BE 04 29.13 N 179 0.50 E GPS	5670	5670						
49MR0706_2	F14N	125	1	BUC 112707 1449	UN 04 29.10 N 179 0.60 E GPS	5670	5670				1		27.4C
49MR0706_2	F14N	125	1	ROS 112707 1609	BO 04 28.87 N 179 0.61 E GPS	5674	5673	10	5689	5764	35	1-8,12,13,23,24,26,27,32,34,43,84,86,87	
49MR0706_2	F14N	125	2	BUC 112707 1727	UN 04 28.88 N 179 0.59 E GPS	5674	5675					34,86,87	PLANKTON NET
49MR0706_2	F14N	125	1	ROS 112707 1826	EN 04 28.66 N 179 0.50 E GPS	5672	5673						
49MR0706_2	F14N	126	1	ROS 112707 2031	BE 04 14.43 N 179 0.48 E GPS	5581	5581						
49MR0706_2	F14N	126	1	BUC 112707 2039	UN 04 14.45 N 179 0.47 E GPS	5580	5581				1		27.5C
49MR0706_2	F14N	126	1	ROS 112707 2158	BO 04 14.46 N 179 0.47 E GPS	5581	5581	9	5594	5670	35	1-8,27	
49MR0706_2	F14N	126	1	ROS 112807 0007	EN 04 14.56 N 179 0.27 E GPS	5576	5575						
49MR0706_2	F14N	127	1	ROS 112807 0203	BE 03 59.51 N 179 0.36 E GPS	5564	5563						
49MR0706_2	F14N	127	1	BUC 112807 0210	UN 03 59.55 N 179 0.34 E GPS	5573	5572				1		27.5C
49MR0706_2		656	1	UNK 112807 0220	UN 03 59.58 N 179 0.34 E GPS	5573	5572						AIR SMPL FOR BVOC #23
49MR0706_2	F14N	127	1	ROS 112807 0330	BO 03 59.54 N 179 0.40 E GPS	5570	5569	10	5584	5659	35	1-8,23,24,26,27	
49MR0706_2		657	1	UNK 112807 0529	UN 03 59.63 N 178 59.63 E GPS	5570	5570						RAIN SMPL FOR STABLE ISOTOPE #30
49MR0706_2	F14N	127	1	ROS 112807 0542	EN 03 59.63 N 178 59.55 E GPS	5592	5591						
49MR0706_2	F14N	128	1	ROS 112807 0733	BE 03 44.48 N 179 0.13 E GPS	5505	5504						
49MR0706_2	F14N	128	1	BUC 112807 0741	UN 03 44.49 N 179 0.07 E GPS	5505	5504				1		27.5C
49MR0706_2	F14N	128	1	ROS 112807 0857	BO 03 44.60 N 179 0.02 E GPS	5504	5504	8	5514	5587	34	1-8,27	
49MR0706_2	F14N	128	1	ROS 112807 1100	EN 03 44.91 N 178 59.93 E GPS	5520	5520						

49MR0706_2	F14N	140	2	ROS	120107	0347	BE	00	44.30	N	178	59.56	E	GPS	5514	5511								
49MR0706_2	F14N	140	2	BUC	120107	0355	UN	00	44.31	N	178	59.45	E	GPS	5511	5509						1	27.9C	
49MR0706_2	F14N	140	2	ROS	120107	0513	BO	00	44.57	N	178	59.27	E	GPS	5521	5520	10	5534	5599			34	1-8,27	CAST 1 CANCELLED DUE TO SENSOR TROUBLE DETECTED AT SURFACE
49MR0706_2	F14N	140	2	ROS	120107	0725	EN	00	44.70	N	178	59.03	E	GPS	5519	5516								
49MR0706_2	F14N	141	1	ROS	120107	0928	BE	00	29.90	N	178	59.99	E	GPS	5409	5409								
49MR0706_2	F14N	141	1	BUC	120107	0939	UN	00	29.88	N	178	59.89	E	GPS	5406	5406						1	27.6C	
49MR0706_2	F14N	141	1	ROS	120107	1054	BO	00	30.03	N	179	0.01	E	GPS	5410	5410	9	5424	5494			35	1-8,23,24,26,27	
49MR0706_2	F14N	141	1	ROS	120107	1310	EN	00	30.12	N	178	59.91	E	GPS	5407	5408								
49MR0706_2	F14N	142	1	ROS	120107	1514	BE	00	14.80	N	178	59.86	E	GPS	5354	5353								
49MR0706_2	F14N	142	1	BUC	120107	1522	UN	00	14.76	N	178	59.77	E	GPS	5353	5352						1	27.3C	
49MR0706_2	F14N	142	1	ROS	120107	1638	BO	00	15.03	N	178	59.83	E	GPS	5348	5347	9	5368	5431			34	1-8,27	
49MR0706_2	F14N	142	1	ROS	120107	1846	EN	00	15.57	N	178	59.68	E	GPS	5351	5350								
49MR0706_2	F14N	143	1	ROS	120107	2051	BE	00	0.00	N	178	59.95	E	GPS	5414	5414								
49MR0706_2	F14N	143	1	BUC	120107	2059	UN	00	0.02	N	178	59.84	E	GPS	5413	5413						1	27.2C	
49MR0706_2	F14N	143	1	ROS	120107	2214	BO	00	0.10	N	179	0.07	E	GPS	5408	5408	9	5428	5457			36	1-8,12,13,23,24,26,27,40,43	#2, #3 EXTRA FOR P014C RAIN SMPL FOR STABLE ISOTOPE #34
49MR0706_2	F14N	662	1	UNK	120107	2359	UN	00	0.10	N	179	0.09	E	GPS	5409	5409								
49MR0706_2	F14N	143	1	ROS	120207	0024	EN	00	0.07	N	179	0.08	E	GPS	5410	5410								
49MR0706_2	F14N	144	1	ROS	120207	0228	BE	00	14.88	S	178	59.52	E	GPS	5462	5460								
49MR0706_2	F14N	144	1	BUC	120207	0237	UN	00	14.90	S	178	59.48	E	GPS	5463	5462						1	27.3C	
49MR0706_2	F14N	144	1	UNK	120207	0242	UN	00	14.90	S	178	59.50	E	GPS	5462	5460								80L THROUGH HULL PUMP FOR R.N. #2 EXTRA FOR R.N.
49MR0706_2	F14N	144	1	ROS	120207	0354	BO	00	14.72	S	178	59.60	E	GPS	5442	5441	9	5475	5545			36	1-8,22,27	
49MR0706_2	F14N	144	1	ROS	120207	0607	EN	00	14.46	S	178	59.59	E	GPS	5368	5366								
49MR0706_2	F14N	145	1	ROS	120307	0756	BE	00	29.87	S	178	59.89	E	GPS	5457	5457								
49MR0706_2	F14N	145	1	BUC	120307	0803	UN	00	29.89	S	178	59.85	E	GPS	5458	5459						1	27.3C	
49MR0706_2	F14N	145	1	ROS	120307	0919	BO	00	29.57	S	178	59.98	E	GPS	5457	5457	10	5482	5545			34	1-8,23,24,26,27	
49MR0706_2	F14N	145	1	ROS	120307	1126	EN	00	29.11	S	178	59.95	E	GPS	5455	5456								
49MR0706_2	F14N	146	1	ROS	120307	1328	BE	00	44.76	S	179	0.25	E	GPS	5445	5444								
49MR0706_2	F14N	146	1	BUC	120307	1336	UN	00	44.78	S	179	0.21	E	GPS	5440	5440						1	27.1C	
49MR0706_2	F14N	146	1	ROS	120307	1454	BO	00	44.45	S	179	0.38	E	GPS	5479	5478	11	5475	5533			34	1-8,27	
49MR0706_2	F14N	146	1	ROS	120307	1709	EN	00	44.03	S	179	0.49	E	GPS	5485	5483								
49MR0706_2	F14N	147	1	ROS	120307	1909	BE	01	0.03	S	179	0.08	E	GPS	5463	5464								
49MR0706_2	F14N	147	1	BUC	120307	1917	UN	01	0.02	S	179	0.04	E	GPS	5459	5462						1	27.0C	
49MR0706_2	F14N	663	1	UNK	120307	1958	UN	00	59.81	S	179	0.07	E	GPS	5468	5469								AIR SMPL FOR BVOC #25
49MR0706_2	F14N	147	1	ROS	120307	2034	BO	00	59.65	S	179	0.04	E	GPS	5474	5476	9	5492	5549			35	1-8,23,24,26,27	
49MR0706_2	F14N	147	1	ROS	120307	2245	EN	00	59.30	S	179	0.18	E	GPS	5487	5488								
49MR0706_2	F14N	148	1	ROS	120407	0051	BE	01	14.87	S	178	59.92	E	GPS	5447	5447								
49MR0706_2	F14N	148	1	BUC	120407	0059	UN	01	14.91	S	178	59.88	E	GPS	5444	5443						1	27.3C	
49MR0706_2	F14N	148	1	ROS	120407	0217	BO	01	14.84	S	178	59.93	E	GPS	5445	5444	9	5457	5529			34	1-8,27	
49MR0706_2	F14N	148	1	ROS	120407	0431	EN	01	14.60	S	178	59.87	E	GPS	5449	5447								
49MR0706_2	F14N	149	1	ROS	120407	0627	BE	01	33.29	S	179	0.06	E	GPS	5464	5462								
49MR0706_2	F14N	149	1	BUC	120407	0635	UN	01	33.28	S	179	0.04	E	GPS	5463	5462						1	27.4C	
49MR0706_2	F14N	149	1	ROS	120407	0752	BO	01	32.87	S	179	0.14	E	GPS	5457	5455	10	5490	5544			34	1-8,23,24,26,27	
49MR0706_2	F14N	149	1	ROS	120407	1000	EN	01	32.50	S	178	59.84	E	GPS	5457	5455								
49MR0706_2	F14N	150	1	ROS	120407	1156	BE	01	44.75	S	178	59.86	E	GPS	5452	5452								
49MR0706_2	F14N	150	1	BUC	120407	1205	UN	01	44.74	S	178	59.86	E	GPS	5452	5453						1	27.4C	
49MR0706_2	F14N	150	1	ROS	120407	1323	BO	01	44.45	S	178	59.86	E	GPS	5450	5451	10	5477	5538			35	1-8,27	
49MR0706_2	F14N	150	1	ROS	120407	1540	EN	01	44.23	S	178	59.89	E	GPS	5456	5456								
49MR0706_2	F14N	151	1	ROS	120407	1744	BE	01	59.95	S	179	0.08	E	GPS	5443	5442								
49MR0706_2	F14N	151	1	BUC	120407	1752	UN	01	59.98	S	179	0.04	E	GPS	5445	5444						1,34,86,87	27.6C, PLANKTON NET	
49MR0706_2	F14N	151	1	ROS	120407	1909	BO	01	59.88	S	179	0.20	E	GPS	5443	5442	10	5462	5528			34	1-8,23,24,26,27,32,34,84,86,87	

49MR0706_2	P14N	151	1	ROS	120407	2120	EN	01	59.71	S	178	59.97	E	GPS	5437	5437					
49MR0706_2	P14N	152	1	ROS	120407	2325	BE	02	15.12	S	179	0.05	E	GPS	5308	5307					
49MR0706_2	P14N	152	1	BUC	120407	2333	UN	02	15.12	S	179	0.01	E	GPS	5307	5307			1		
49MR0706_2	P14N	152	1	ROS	120507	0047	BO	02	15.07	S	178	59.94	E	GPS	5300	5299	10	5303	5374	33 1-8,27	27.8C
49MR0706_2	P14N	152	1	ROS	120507	0257	EN	02	14.99	S	178	59.85	E	GPS	5306	5305					
49MR0706_2	P14N	153	1	ROS	120507	0457	BE	02	30.09	S	179	0.09	E	GPS	4953	4953					
49MR0706_2	P14N	153	1	BUC	120507	0505	UN	02	30.10	S	179	0.10	E	GPS	4997	4997				1	27.8C
49MR0706_2	P14N	153	1	UNK	120507	0513	UN	02	30.08	S	179	0.12	E	GPS	4935	4935					20L THROUGH HULL PUMP FOR R.N.
49MR0706_2	P14N	153	1	ROS	120507	0619	BO	02	29.77	S	178	59.95	E	GPS	4860	4859	11	5044	4994	33 1-8,27	
49MR0706_2	P14N	153	1	ROS	120507	0820	EN	02	29.33	S	178	59.56	E	GPS	4781	4781					
49MR0706_2	P14N	154	1	ROS	120507	1025	BE	02	44.98	S	179	0.14	E	GPS	5499	5499					
49MR0706_2	P14N	154	1	BUC	120507	1033	UN	02	44.98	S	179	0.11	E	GPS	5503	5503				1	27.5C
49MR0706_2	P14N	154	1	ROS	120507	1150	BO	02	44.76	S	178	59.92	E	GPS	5499	5500	10	5524	5590	35 1-8,23,24,26,27	
49MR0706_2	P14N	154	1	ROS	120507	1411	EN	02	44.39	S	178	59.53	E	GPS	5501	5501					
49MR0706_2	P14N	155	1	ROS	120507	1616	BE	02	59.75	S	179	0.16	E	GPS	5461	5462					
49MR0706_2	P14N	155	1	BUC	120507	1624	UN	02	59.73	S	179	0.10	E	GPS	5471	5472				1	27.8C
49MR0706_2	P14N	155	1	ROS	120507	1742	BO	02	59.10	S	178	59.76	E	GPS	5476	5477	9	5559	5549	34 1-8,27	
49MR0706_2	P14N	155	1	ROS	120507	1955	EN	02	58.33	S	178	59.38	E	GPS	5478	5478					
49MR0706_2	P14N	156	1	ROS	120507	2159	BE	03	14.69	S	179	0.19	E	GPS	5131	5130					
49MR0706_2	P14N	156	1	BUC	120507	2208	UN	03	14.68	S	179	0.11	E	GPS	5120	5118				1	28.1C
49MR0706_2	P14N	156	1	ROS	120507	2319	BO	03	14.44	S	178	59.77	E	GPS	5165	5163	10	5176	5223	34 1-8,27	
49MR0706_2	P14N	156	1	ROS	120607	0129	EN	03	13.74	S	178	58.90	E	GPS	5266	5265					
49MR0706_2	P14N	157	1	ROS	120607	0328	BE	03	29.80	S	179	0.39	E	GPS	5221	5221					
49MR0706_2	P14N	157	1	BUC	120607	0336	UN	03	29.83	S	179	0.32	E	GPS	5220	5220				1	28.0C
49MR0706_2	P14N	664	1	UNK	120607	0400	UN	03	29.82	S	179	0.23	E	GPS	5220	5220					AIR SMPL FOR EVOC #26
49MR0706_2	P14N	157	1	ROS	120607	0450	BO	03	29.73	S	179	0.19	E	GPS	5220	5220	10	5237	5299	33 1-8,23,24,26,27	
49MR0706_2	P14N	157	1	ROS	120607	0653	EN	03	29.87	S	178	59.62	E	GPS	5230	5231					
49MR0706_2	P14N	158	1	ROS	120607	0853	BE	03	45.00	S	179	0.24	E	GPS	5550	5550					
49MR0706_2	P14N	158	1	BUC	120607	0902	UN	03	45.05	S	179	0.17	E	GPS	5550	5550				1	27.9C
49MR0706_2	P14N	158	1	ROS	120607	1019	BO	03	44.90	S	178	59.87	E	GPS	5545	5545	11	5575	5636	35 1-8,27	
49MR0706_2	P14N	158	1	ROS	120607	1235	EN	03	44.76	S	178	59.44	E	GPS	5535	5535					
49MR0706_2	P14N	159	1	ROS	120607	1440	BE	04	0.41	S	179	0.35	E	GPS	5243	5243					
49MR0706_2	P14N	665	1	UNK	120607	1442	UN	04	0.44	S	179	0.33	E	GPS	5246	5244					RAIN SMPL FOR STABLE ISOTOPE #35
49MR0706_2	P14N	159	1	BUC	120607	1450	UN	04	0.48	S	179	0.28	E	GPS	5256	5255				1	27.9C
49MR0706_2	P14N	159	1	ROS	120607	1603	BO	04	0.42	S	179	0.19	E	GPS	5256	5255	9	5266	5333	34 1-8,27,28	
49MR0706_2	P14N	159	1	ROS	120607	1822	EN	04	0.26	S	179	0.01	E	GPS	5246	5246					
49MR0706_2	P14N	160	1	ROS	120607	2026	BE	04	15.47	S	178	59.99	E	GPS	5637	5637					
49MR0706_2	P14N	160	1	BUC	120607	2035	UN	04	15.48	S	178	59.90	E	GPS	5636	5637				1	28.0C
49MR0706_2	P14N	160	1	ROS	120607	2153	BO	04	15.49	S	178	59.66	E	GPS	5631	5631	9	5648	5722	36 1-8,12,13,23,24,26,27,40,43	#2 EXTRA FOR PO14C
49MR0706_2	P14N	160	1	ROS	120707	0015	EN	04	15.92	S	178	59.55	E	GPS	5636	5636					
49MR0706_2	P14N	161	1	ROS	120707	0218	BE	04	30.40	S	179	0.51	E	GPS	5636	5635					
49MR0706_2	P14N	161	1	UNK	120707	0225	UN	04	30.46	S	179	0.53	E	GPS	5644	5642					80L THROUGH HULL PUMP FOR R.N.
49MR0706_2	P14N	161	1	BUC	120707	0226	UN	04	30.43	S	179	0.52	E	GPS	5633	5632				1	28.4C
49MR0706_2	P14N	161	1	ROS	120707	0346	BO	04	30.47	S	179	0.53	E	GPS	5638	5638	10	5664	5742	36 1-8,22,27	#2 EXTRA FOR R.N.
49MR0706_2	P14N	161	1	ROS	120707	0603	EN	04	30.45	S	179	0.44	E	GPS	5621	5620					
49MR0706_2	P14N	162	1	ROS	120707	0831	BE	04	45.44	S	179	0.28	E	GPS	3805	3805					
49MR0706_2	P14N	162	1	BUC	120707	0839	UN	04	45.46	S	179	0.29	E	GPS	3819	3818				1	28.2C
49MR0706_2	P14N	162	1	ROS	120707	0934	BO	04	45.31	S	179	0.31	E	GPS	3826	3826	8	3847	3882	28 1-8,23,24,26,27	
49MR0706_2	P14N	162	1	ROS	120707	1109	EN	04	45.22	S	179	0.19	E	GPS	3735	3735					
49MR0706_2	P14N	163	1	ROS	120707	1342	BE	05	0.09	S	179	0.12	E	GPS	5485	5486					
49MR0706_2	P14N	163	1	BUC	120707	1350	UN	05	0.01	S	179	0.10	E	GPS	5472	5473				1	28.7C

49MR0706_2	F14N	163	1	ROS	120707	1509	BO 04	59.91	S	179	0.06	E	GPS	5546	5546	9	5513	5584	35	1-8,27,32,34,84,86,87	#2 EXTRA AT 100DBAR PLANKTON NET
49MR0706_2	F14N	163	2	BUC	120707	1559	UN 04	59.90	S	178	59.89	E	GPS	5553	5553					34,86,87	
49MR0706_2	F14N	163	1	ROS	120707	1724	EN 04	59.45	S	178	59.60	E	GPS	5551	5552						
49MR0706_2	F14N	164	1	ROS	120707	2023	BE 05	29.93	S	179	0.31	E	GPS	5687	5687						
49MR0706_2	F14N	164	1	BUC	120707	2031	UN 05	29.87	S	179	0.27	E	GPS	5691	5691					1	29.4C
49MR0706_2	F14N	164	1	ROS	120707	2149	BO 05	29.61	S	178	59.97	E	GPS	5704	5704	9	5716	5786	35	1-8,23,24,26,27	
49MR0706_2	F14N	164	1	ROS	120807	0008	EN 05	29.11	S	178	59.37	E	GPS	5702	5702						
49MR0706_2	F14N	165	1	ROS	120807	0308	BE 06	0.47	S	179	0.45	E	GPS	5426	5425						
49MR0706_2	F14N	165	1	BUC	120807	0317	UN 06	0.48	S	179	0.48	E	GPS	5407	5405					1	29.4C
49MR0706_2	F14N	666	1	UNK	120807	0333	UN 06	0.48	S	179	0.47	E	GPS	5407	5406						AIR SMPL FOR BVOC #27
49MR0706_2	F14N	165	1	ROS	120807	0432	BO 06	0.53	S	179	0.42	E	GPS	5404	5403	9	5418	5491	35	1-8,27	
49MR0706_2	F14N	165	1	ROS	120807	0645	EN 06	0.32	S	179	0.91	E	GPS	5430	5429						
49MR0706_2	F14N	166	1	ROS	120807	0908	BE 06	29.86	S	178	59.84	E	GPS	5355	5355						
49MR0706_2	F14N	166	1	BUC	120807	0917	UN 06	29.77	S	178	59.90	E	GPS	5348	5346					1	29.1C
49MR0706_2	F14N	166	1	ROS	120807	1031	BO 06	29.75	S	178	59.83	E	GPS	5353	5352	10	5363	5427	34	1-8,23,24,26,27	
49MR0706_2	F14N	166	1	ROS	120807	1247	EN 06	29.58	S	178	59.64	E	GPS	5347	5347						
49MR0706_2	F14N	167	1	ROS	120807	1511	BE 06	59.95	S	179	0.08	E	GPS	5485	5486						
49MR0706_2	F14N	167	1	BUC	120807	1520	UN 06	59.97	S	179	0.06	E	GPS	5484	5485					1	28.5C
49MR0706_2	F14N	167	1	UNK	120807	1522	UN 06	59.96	S	179	0.06	E	GPS	5479	5480						20L THROUGH HULL PUMP FOR R.N.
49MR0706_2	F14N	167	1	ROS	120807	1636	BO 07	0.05	S	178	59.64	E	GPS	5466	5467	10	5502	5554	34	1-8,27,28	
49MR0706_2	F14N	167	1	ROS	120807	1853	EN 06	59.87	S	178	58.55	E	GPS	5508	5510						
49MR0706_2	F14N	168	1	ROS	120807	2112	BE 07	29.95	S	178	59.89	E	GPS	2103	2103						
49MR0706_2	F14N	168	1	BUC	120807	2121	UN 07	29.99	S	178	59.86	E	GPS	2127	2126					1	29.4C
49MR0706_2	F14N	168	1	ROS	120807	2154	BO 07	30.00	S	178	59.76	E	GPS	2156	2156	10	2144	2154	20	1-8,23,24,26,27	
49MR0706_2	F14N	168	1	ROS	120807	2254	EN 07	29.94	S	178	59.61	E	GPS	2159	2158						
49MR0706_2	F14N	169	1	ROS	120907	0114	BE 07	59.87	S	179	0.27	E	GPS	5082	5081						
49MR0706_2	F14N	169	1	BUC	120907	0122	UN 07	59.90	S	179	0.24	E	GPS	5082	5082					1	29.4C
49MR0706_2	F14N	169	1	ROS	120907	0234	BO 07	59.80	S	179	0.07	E	GPS	5082	5082	10	5096	5156	33	1-8,23,24,26,27	
49MR0706_2	F14N	169	1	ROS	120907	0439	EN 08	0.20	S	178	59.53	E	GPS	5084	5085						
49MR0706_2	F14N	170	1	ROS	120907	0705	BE 08	29.95	S	178	44.94	E	GPS	4839	4839						
49MR0706_2	F14N	170	1	BUC	120907	0713	UN 08	29.99	S	178	44.93	E	GPS	4839	4838					1	29.5C
49MR0706_2	F14N	667	1	UNK	120907	0738	UN 08	30.11	S	178	44.93	E	GPS	4839	4838						AIR SMPL FOR BVOC #28
49MR0706_2	F14N	170	1	ROS	120907	0822	BO 08	30.23	S	178	44.90	E	GPS	4838	4837	10	4849	4902	32	1-8,23,24,26,27	
49MR0706_2	F14N	170	1	ROS	120907	1022	EN 08	30.33	S	178	44.52	E	GPS	4837	4836						
49MR0706_2	F14N	171	1	ROS	120907	1257	BE 09	0.01	S	178	59.88	E	GPS	5014	5013						
49MR0706_2	F14N	171	1	BUC	120907	1305	UN 09	0.03	S	178	59.90	E	GPS	5013	5013					1	29.2C
49MR0706_2	F14N	171	1	ROS	120907	1415	BO 09	0.19	S	178	59.92	E	GPS	5013	5013	10	5026	5083	36	1-8,12,13,23,24,26,27,32,34,40,43,84,86,87	#2, #3, #4 EXTRA FOR P014C PLANKTON NET
49MR0706_2	F14N	171	2	BUC	120907	1550	UN 09	0.43	S	178	59.94	E	GPS	5019	5018					34,86,87	
49MR0706_2	F14N	171	1	ROS	120907	1625	EN 09	0.54	S	179	0.03	E	GPS	5017	5017						SEC CND SENSOR BROKE
49MR0706_2	F14N	668	1	UNK	120907	1825	UN 09	26.28	S	178	59.86	E	GPS	3895	3895						RAIN SMPL FOR STABLE ISOTOPE #36 REPLACED SEC CND SENSOR
49MR0706_2	F14N	172	1	ROS	120907	1911	BE 09	29.85	S	178	59.95	E	GPS	4602	4603						
49MR0706_2	F14N	172	1	BUC	120907	1919	UN 09	29.86	S	178	59.95	E	GPS	4600	4600					1	29.3C
49MR0706_2	F14N	172	1	UNK	120907	1921	UN 09	29.86	S	178	59.95	E	GPS	4587	4587						80L THROUGH HULL PUMP FOR R.N.
49MR0706_2	F14N	172	1	ROS	120907	2024	BO 09	30.03	S	178	59.90	E	GPS	4589	4589	8	4599	4648	36	1-8,22,27	#2-#6 EXTRA FOR R.N.
49MR0706_2	F14N	172	1	ROS	120907	2221	EN 09	30.07	S	178	59.53	E	GPS	4658	4659						
49MR0706_2	F14N	173	1	ROS	121007	0045	BE 10	0.09	S	178	59.90	E	GPS	4755	4754						
49MR0706_2	F14N	173	1	BUC	121007	0054	UN 10	0.13	S	178	59.90	E	GPS	4753	4753					1	29.2C
49MR0706_2	F14N	173	1	ROS	121007	0201	BO 10	0.35	S	178	59.85	E	GPS	4756	4755	10	4775	4819	31	1-8,23,24,26,27	
49MR0706_2	F14N	173	1	ROS	121007	0402	EN 10	0.53	S	178	59.89	E	GPS	4756	4756						
49MR0706_2	F14N	174	1	ROS	121007	0620	BE 10	30.31	S	178	59.91	E	GPS	4411	4409						
49MR0706_2	F14N	174	1	BUC	121007	0628	UN 10	30.34	S	178	59.91	E	GPS	4418	4417					1	29.5C

49MR0706_2	F14N	174	1	ROS	121007	0733	BO	10	30.52	S	178	59.81	E	GPS	4455	4454	9	4474	4518	31	1-8,27		
49MR0706_2	F14N	174	1	ROS	121007	0925	EN	10	30.71	S	178	59.72	E	GPS	4515	4514							
49MR0706_2	F14N	175	1	ROS	121007	1150	BE	11	0.27	S	178	59.95	E	GPS	3097	3096							
49MR0706_2	F14N	175	1	BUC	121007	1158	UN	11	0.28	S	178	59.95	E	GPS	3094	3094					1		29.3C
49MR0706_2		669	1	UNK	121007	1221	UN	11	0.28	S	179	0.02	E	GPS	3094	3093							AIR SMPL FOR BVOC #29
49MR0706_2	F14N	175	1	ROS	121007	1245	BO	11	0.21	S	178	59.96	E	GPS	3116	3116	11	3113	3132	25	1-8,23,24,26,27		
49MR0706_2	F14N	175	1	ROS	121007	1412	EN	11	0.01	S	178	59.78	E	GPS	3149	3149							
49MR0706_2	F14N	176	1	ROS	121007	1632	BE	11	30.44	S	178	59.74	E	GPS	3105	3103							
49MR0706_2	F14N	176	1	UNK	121007	1635	UN	11	30.54	S	178	59.74	E	GPS	3103	3102							20L THROUGH HULL PUMP FOR R.N.
49MR0706_2	F14N	176	1	BUC	121007	1641	UN	11	30.50	S	178	59.73	E	GPS	3104	3103					1		29.2C
49MR0706_2	F14N	176	2	BUC	121007	1656	UN	11	30.52	S	178	59.71	E	GPS	3104	3103					34,86,87		PLANKTON NET
49MR0706_2	F14N	176	1	ROS	121007	1725	BO	11	30.66	S	178	59.75	E	GPS	3104	3102	9	3109	3131	25	1-8,27,28		
49MR0706_2	F14N	176	1	ROS	121007	1848	EN	11	30.90	S	178	59.80	E	GPS	3102	3100							
49MR0706_2	F14N	177	1	ROS	121007	2104	BE	12	0.20	S	179	0.54	E	GPS	2588	2588							
49MR0706_2	F14N	177	1	BUC	121007	2112	UN	12	0.21	S	179	0.52	E	GPS	2583	2583					1		28.9C
49MR0706_2	F14N	177	1	ROS	121007	2148	BO	12	0.26	S	179	0.51	E	GPS	2573	2572	8	2580	2598	23	1-8,23,24,26,27		
49MR0706_2	F14N	177	1	ROS	121007	2259	EN	12	0.37	S	179	0.39	E	GPS	2556	2555							
49MR0706_2	F14N	178	1	ROS	121107	0117	BE	12	30.34	S	179	0.29	E	GPS	2789	2789							
49MR0706_2	F14N	178	1	UNK	121107	0123	UN	12	30.35	S	179	0.25	E	GPS	2815	2816							80L THROUGH HULL PUMP FOR R.N.
49MR0706_2	F14N	178	1	BUC	121107	0125	UN	12	30.36	S	179	0.21	E	GPS	2835	2836					1		29.4C
49MR0706_2	F14N	178	1	ROS	121107	0205	BO	12	30.11	S	178	59.99	E	GPS	2624	2625	7	2766	-9	0			WINCH TROUBLE NEAR BOTTOM, CAST CANCELLED
49MR0706_2	F14N	178	1	ROS	121107	0324	EN	12	30.32	S	178	59.55	E	GPS	2558	2558							
49MR0706_2	F14N	178	2	ROS	121107	0401	BE	12	30.95	S	179	1.04	E	GPS	3007	3009							
49MR0706_2	F14N	178	2	BUC	121107	0409	UN	12	30.92	S	179	1.05	E	GPS	3024	3026					1		30.2C
49MR0706_2	F14N	178	2	UNK	121107	0414	UN	12	30.91	S	179	1.06	E	GPS	3025	3025							80L THROUGH HULL PUMP FOR R.N.
49MR0706_2	F14N	178	2	ROS	121107	0508	BO	12	30.73	S	179	0.96	E	GPS	3031	3032	16	3025	3046	32	1-8,22,27		#2-#5,#7-#10 EXTRA FOR R.N.
49MR0706_2	F14N	178	2	ROS	121107	0631	EN	12	30.56	S	179	0.61	E	GPS	2963	2964							
49MR0706_2	F14N	179	1	ROS	121107	0844	BE	13	0.01	S	178	59.66	E	GPS	1556	1556							
49MR0706_2	F14N	179	1	BUC	121107	0852	UN	13	0.00	S	178	59.61	E	GPS	1556	1555					1		29.2C
49MR0706_2	F14N	179	1	ROS	121107	0913	BO	12	59.94	S	178	59.55	E	GPS	1557	1556	9	1556	1561	17	1-8,23,24,26,27		
49MR0706_2	F14N	179	1	ROS	121107	0959	EN	12	59.81	S	178	59.49	E	GPS	1539	1538							
49MR0706_2	F14N	180	1	ROS	121107	1215	BE	13	29.79	S	179	0.14	E	GPS	3057	3057							
49MR0706_2	F14N	180	1	BUC	121107	1223	UN	13	29.76	S	179	0.13	E	GPS	3058	3059					1		29.3C
49MR0706_2		670	1	UNK	121107	1239	UN	13	29.67	S	179	0.09	E	GPS	3059	3060							AIR SMPL FOR BVOC #30
49MR0706_2	F14N	180	1	ROS	121107	1308	BO	13	29.60	S	179	0.27	E	GPS	3147	3148	11	3073	3088	25	1-8,12,13,23,24,26,27		
49MR0706_2	F14N	180	1	ROS	121107	1433	EN	13	29.23	S	179	0.63	E	GPS	3173	3173							
49MR0706_2	F14N	181	1	ROS	121107	1652	BE	13	59.91	S	179	0.02	E	GPS	1469	1468							
49MR0706_2	F14N	181	1	BUC	121107	1700	UN	13	59.88	S	179	0.01	E	GPS	1472	1472					1,34,86,87		29.0C
49MR0706_2	F14N	181	1	ROS	121107	1722	BO	13	59.87	S	179	0.12	E	GPS	1477	1476	11	1470	1471	18	1-8,23,24,26,27,32,34,84,86,87		#14 EXTRA FOR 32,34,84,86,87
49MR0706_2	F14N	181	1	ROS	121107	1808	EN	13	59.76	S	179	0.21	E	GPS	1481	1479							
49MR0706_2	F14N	182	1	ROS	121107	2026	BE	14	30.05	S	178	59.78	E	GPS	2263	2261							
49MR0706_2	F14N	182	1	BUC	121107	2033	UN	14	30.02	S	178	59.78	E	GPS	2261	2261					1		28.9C
49MR0706_2	F14N	182	1	ROS	121107	2108	BO	14	30.00	S	178	59.81	E	GPS	2246	2245	14	2290	2303	20	1-8,27,28		
49MR0706_2	F14N	182	1	ROS	121107	2207	EN	14	29.90	S	179	0.06	E	GPS	2247	2245							OPTODE PROTOTYPE #1 BROKE
49MR0706_2	F14N	183	1	ROS	121207	0023	BE	14	59.88	S	178	59.54	E	GPS	2356	2355							
49MR0706_2	F14N	183	1	UNK	121207	0029	UN	14	59.85	S	178	59.53	E	GPS	2354	2354							80L THROUGH HULL PUMP FOR R.N.
49MR0706_2	F14N	183	1	BUC	121207	0031	UN	14	59.84	S	178	59.53	E	GPS	2348	2347					1		29.3C
49MR0706_2	F14N	183	1	ROS	121207	0107	BO	14	59.62	S	178	59.49	E	GPS	2409	2409	14	2391	2397	30	1-8,22,27		#2-#5,#7-#10 EXTRA FOR R.N.
49MR0706_2	F14N	183	1	ROS	121207	0220	EN	14	59.49	S	178	59.52	E	GPS	2383	2383							
49MR0706_2	F14N	184	1	ROS	121207	0436	BE	15	29.83	S	178	59.93	E	GPS	2605	2606							

49MR0706_2	F14N	184	1	BUC	121207	0444	UN	15	29.79	S	178	59.84	E	GPS	2600	2601									1						29.2C	
49MR0706_2	F14N	184	1	ROS	121207	0521	BO	15	29.68	S	178	59.65	E	GPS	2579	2580	11	2589	2606							22	1-8,23,24,26,27					
49MR0706_2	F14N	184	1	ROS	121207	0634	EN	15	29.65	S	178	59.54	E	GPS	2572	2573																
49MR0706_2	F14N	185	1	ROS	121207	0844	BE	15	58.67	S	178	59.91	E	GPS	1471	1470																
49MR0706_2	F14N	185	1	BUC	121207	0851	UN	15	58.64	S	178	59.89	E	GPS	1472	1472											1					28.8C
49MR0706_2		671	1	UNK	121207	0902	UN	15	58.57	S	178	59.85	E	GPS	1474	1473																AIR SMPL FOR BVOC #31
49MR0706_2	F14N	185	1	ROS	121207	0911	BO	15	58.51	S	178	59.86	E	GPS	1474	1474	10	1471	1474							16	1-8,23,24,26,27					
49MR0706_2	F14N	185	1	ROS	121207	0954	EN	15	58.30	S	178	59.76	E	GPS	1481	1481																
49MR0706_2	F14C	48	1	ROS	121307	1200	BE	18	52.97	S	177	45.05	E	GPS	2125	2124																REPLACED A FOIL OF OPTODE PROTOTYPE #2
49MR0706_2	F14C	48	1	BUC	121307	1208	UN	18	53.00	S	177	45.07	E	GPS	2126	2126											1					28.3C
49MR0706_2	F14C	48	1	ROS	121307	1241	BO	18	53.06	S	177	44.97	E	GPS	2146	2146	12	2160	2171							20	1-8,23,24,26,27					
49MR0706_2	F14C	48	1	ROS	121307	1343	EN	18	53.14	S	177	44.70	E	GPS	2217	2218																
49MR0706_2	F14C	49	1	ROS	121307	1545	BE	18	45.02	S	177	49.78	E	GPS	1934	1933																
49MR0706_2	F14C	49	1	BUC	121307	1554	UN	18	45.03	S	177	49.74	E	GPS	1930	1930											1					28.3C
49MR0706_2	F14C	49	1	ROS	121307	1622	BO	18	45.06	S	177	49.65	E	GPS	1919	1918	9	1918	1926							19	1-8,27					
49MR0706_2	F14C	49	1	ROS	121307	1721	EN	18	44.98	S	177	49.40	E	GPS	1917	1916																
49MR0706_2	F14C	52	1	ROS	121307	1915	BE	18	32.27	S	177	55.71	E	GPS	645	644																
49MR0706_2	F14C	52	1	BUC	121307	1918	UN	18	32.25	S	177	55.73	E	GPS	616	615											1					28.2C
49MR0706_2		672	1	UNK	121307	1927	UN	18	32.21	S	177	55.71	E	GPS	608	608																AIR SMPL FOR BVOC #32
49MR0706_2	F14C	52	1	ROS	121307	1931	BO	18	32.19	S	177	55.71	E	GPS	601	601	15	616	621							11	1-8,23,24,26,27					
49MR0706_2	F14C	52	1	ROS	121307	1955	EN	18	32.12	S	177	55.68	E	GPS	594	595																
49MR0706_2	F14C	51	1	ROS	121307	2159	BE	18	35.88	S	177	56.05	E	GPS	895	896																
49MR0706_2	F14C	51	1	BUC	121307	2207	UN	18	35.90	S	177	55.99	E	GPS	884	884											1					28.1C
49MR0706_2	F14C	51	1	ROS	121307	2219	BO	18	35.86	S	177	55.98	E	GPS	891	892	10	872	876							13	1-8,27					
49MR0706_2	F14C	51	1	ROS	121307	2251	EN	18	35.68	S	177	55.87	E	GPS	854	855																
49MR0706_2	F14C	50	1	ROS	121407	0051	BE	18	39.67	S	177	52.56	E	GPS	1128	1128																
49MR0706_2	F14C	50	1	UNK	121407	0055	UN	18	39.68	S	177	52.53	E	GPS	1128	1127																20L THROUGH HULL PUMP FOR R.N.
49MR0706_2	F14C	50	1	BUC	121407	0059	UN	18	39.68	S	177	52.48	E	GPS	1127	1127											1					28.1C
49MR0706_2	F14C	50	1	ROS	121407	0117	BO	18	39.69	S	177	52.43	E	GPS	1127	1126	10	1122	1126							16	1-8,23,24,26,27					#24 LIKELY MISS TRIP (ABNORMALLY WARM)
49MR0706_2	F14C	50	1	ROS	121407	0156	EN	18	39.72	S	177	52.36	E	GPS	1129	1130																
49MR0706_2	F14C	47	1	ROS	121407	0401	BE	19	3.01	S	177	38.50	E	GPS	2543	2543																
49MR0706_2	F14C	47	1	BUC	121407	0409	UN	19	2.99	S	177	38.49	E	GPS	2537	2536											1					28.3C
49MR0706_2	F14C	47	1	ROS	121407	0444	BO	19	2.85	S	177	38.46	E	GPS	2518	2518	10	2519	2537							22	1-8,27,28					
49MR0706_2	F14C	47	1	ROS	121407	0556	EN	19	2.85	S	177	38.39	E	GPS	2492	2492																
49MR0706_2	F14C	46	1	ROS	121407	0757	BE	19	12.89	S	177	34.78	E	GPS	3011	3011																
49MR0706_2	F14C	46	1	BUC	121407	0805	UN	19	12.86	S	177	34.74	E	GPS	3013	3013											1					28.0C
49MR0706_2	F14C	46	1	UNK	121407	0813	UN	19	12.83	S	177	34.70	E	GPS	3013	3013																80L THROUGH HULL PUMP FOR R.N.
49MR0706_2	F14C	46	1	ROS	121407	0847	BO	19	12.69	S	177	34.65	E	GPS	3011	3011	9	3020	3038							33	1-8,22,27					#2-#5,#7-#10 EXTRA FOR R.N.
49MR0706_2	F14C	46	1	ROS	121407	1010	EN	19	12.50	S	177	34.53	E	GPS	3009	3010																
49MR0706_2	F14C	45	1	ROS	121407	1216	BE	19	23.93	S	177	29.30	E	GPS	3162	3162																
49MR0706_2	F14C	45	1	BUC	121407	1224	UN	19	23.91	S	177	29.29	E	GPS	3163	3161											1					27.9C
49MR0706_2	F14C	45	1	ROS	121407	1310	BO	19	23.78	S	177	29.34	E	GPS	3157	3157	9	3163	3188							25	1-8,23,24,26,27					
49MR0706_2	F14C	45	1	ROS	121407	1445	EN	19	23.50	S	177	29.47	E	GPS	3159	3158																
49MR0706_2	F14C	44	1	ROS	121407	1649	BE	19	38.01	S	177	22.00	E	GPS	2535	2536																
49MR0706_2	F14C	44	1	BUC	121407	1659	UN	19	38.01	S	177	22.00	E	GPS	2524	2526											1,34,86,87					27.5C, PLANKTON NET
49MR0706_2	F14C	44	1	ROS	121407	1735	BO	19	38.04	S	177	21.85	E	GPS	2544	2545	18	2518	2528							22	1-8,23,24,26,27,32,34,84,86,87					
49MR0706_2	F14C	44	1	ROS	121407	1846	EN	19	38.08	S	177	21.77	E	GPS	2575	2576																
49MR0706_2	F14C	43	1	ROS	121407	2049	BE	19	49.06	S	177	24.09	E	GPS	3200	3200																
49MR0706_2	F14C	43	1	BUC	121407	2057	UN	19	49.02	S	177	24.07	E	GPS	3212	3212											1					27.5C
49MR0706_2	F14C	43	1	ROS	121407	2143	BO	19	48.95	S	177	24.03	E	GPS	3247	3246	13	3213	3239							26	1-8,23,24,26,27					
49MR0706_2	F14C	43	1	ROS	121407	2306	EN	19	48.54	S	177	24.15	E	GPS	3193	3192																

49MR0706_2	F14C	42	1	ROS 121507 0112	BE 20	7.81	S	177	32.18	E	GPS	2560	2560							
49MR0706_2	F14C	42	1	BUC 121507 0122	UN 20	7.82	S	177	32.15	E	GPS	2560	2559						1	27.5C
49MR0706_2	F14C	42	1	ROS 121507 0157	BO 20	7.79	S	177	32.20	E	GPS	2570	2570	11	2565	2582		22	1-8,27	
49MR0706_2	F14C	42	1	ROS 121507 0308	EN 20	7.58	S	177	32.07	E	GPS	-9	-9							
49MR0706_2	F14C	41	1	ROS 121507 0633	BE 20	22.31	S	177	38.07	E	GPS	3012	3011							
49MR0706_2	F14C	41	1	BUC 121507 0641	UN 20	22.35	S	177	38.09	E	GPS	2980	2979						1	27.3C
49MR0706_2	F14C	41	1	ROS 121507 0723	BO 20	22.34	S	177	38.20	E	GPS	2976	2975	9	2980	3001		24	1-8,23,24,26,27	
49MR0706_2	F14C	41	1	ROS 121507 0846	EN 20	22.37	S	177	38.19	E	GPS	2955	2954							
49MR0706_2	F14C	40	1	ROS 121507 1045	BE 20	37.77	S	177	35.61	E	GPS	3081	3081							IADCP REPLACED FROM S/N 8484 TO S/N 2553
49MR0706_2	F14C	40	1	BUC 121507 1052	UN 20	37.80	S	177	35.58	E	GPS	3079	3079						1	26.8C
49MR0706_2	F14C	40	1	UNK 121507 1054	UN 20	37.80	S	177	35.58	E	GPS	3081	3081							20L THROUGH HULL PUMP FOR R.N.
49MR0706_2	F14C	40	1	ROS 121507 1135	BO 20	37.72	S	177	35.54	E	GPS	3084	3084	10	3086	3109		25	1-8,27	
49MR0706_2	F14C	40	1	ROS 121507 1303	EN 20	37.60	S	177	35.61	E	GPS	3090	3090							
49MR0706_2	F14C	39	1	ROS 121507 1500	BE 20	52.09	S	177	33.32	E	GPS	3192	3191							
49MR0706_2	F14C	39	1	BUC 121507 1509	UN 20	52.04	S	177	33.32	E	GPS	3189	3189						1	27.3C
49MR0706_2	F14C	39	1	ROS 121507 1559	BO 20	51.90	S	177	33.23	E	GPS	3188	3188	9	3195	3220		25	1-8,23,24,26,27	
49MR0706_2	F14C	39	2	BUC 121507 1643	UN 20	51.78	S	177	33.20	E	GPS	3145	3145						34,86,87	PLANKTON NET
49MR0706_2	F14C	39	1	ROS 121507 1732	EN 20	51.58	S	177	33.17	E	GPS	3144	3143							
49MR0706_2	F14C	38	1	ROS 121507 1941	BE 21	7.01	S	177	30.87	E	GPS	3354	3354							
49MR0706_2	F14C	38	1	BUC 121507 1950	UN 21	6.99	S	177	30.89	E	GPS	3357	3357						1	27.4C
49MR0706_2		673	1	UNK 121507 2005	UN 21	7.01	S	177	30.87	E	GPS	3354	3353							AIR SMPL FOR BVOC #33
49MR0706_2	F14C	38	1	ROS 121507 2037	BO 21	7.09	S	177	30.79	E	GPS	3355	3355	10	3361	3388		26	1-8,27,28	
49MR0706_2	F14C	38	1	ROS 121507 2208	EN 21	7.31	S	177	30.53	E	GPS	3367	3366							
49MR0706_2	F14C	37	1	ROS 121607 0000	BE 21	25.35	S	177	27.91	E	GPS	3800	3800							
49MR0706_2	F14C	37	1	BUC 121607 0009	UN 21	25.36	S	177	27.94	E	GPS	3799	3799						1	27.1C
49MR0706_2	F14C	37	1	ROS 121607 0103	BO 21	25.45	S	177	27.95	E	GPS	3802	3800	13	3800	3838		28	1-8,12,13,23,24,26,27	
49MR0706_2	F14C	37	1	ROS 121607 0255	EN 21	25.56	S	177	28.16	E	GPS	3803	3802							
49MR0706_2		674	1	UNK 121607 0257	UN 21	25.56	S	177	28.21	E	GPS	3803	3802							RAIN SMPL FOR STABLE ISOTOPE #37
49MR0706_2	F14C	36	1	ROS 121607 0451	BE 21	46.11	S	177	24.17	E	GPS	3985	3983							
49MR0706_2	F14C	36	1	BUC 121607 0501	UN 21	46.06	S	177	24.12	E	GPS	3984	3983						1	25.7C
49MR0706_2	F14C	36	1	UNK 121607 0513	UN 21	46.03	S	177	24.11	E	GPS	3983	3982							80L THROUGH HULL PUMP FOR R.N.
49MR0706_2	F14C	36	1	ROS 121607 0556	BO 21	46.09	S	177	24.04	E	GPS	3984	3983	11	3984	4027		36	1-8,22,27	#2-#9 EXTRA FOR R.N.
49MR0706_2	F14C	36	1	ROS 121607 0739	EN 21	46.13	S	177	24.39	E	GPS	3984	3983							
49MR0706_2	F14C	35	1	ROS 121607 0943	BE 22	12.07	S	177	19.73	E	GPS	4169	4169							
49MR0706_2	F14C	35	1	BUC 121607 0951	UN 22	12.04	S	177	19.67	E	GPS	4167	4166						1	25.2C
49MR0706_2	F14C	35	1	ROS 121607 1049	BO 22	11.96	S	177	19.67	E	GPS	4170	4170	9	4175	4219		28	1-8,23,24,26,27	#11 MISS FIRE
49MR0706_2	F14C	35	1	ROS 121607 1237	EN 22	11.76	S	177	19.57	E	GPS	4167	4167							
49MR0706_2	F14C	34	1	ROS 121607 1447	BE 22	38.01	S	177	15.44	E	GPS	4203	4203							
49MR0706_2	F14C	34	1	BUC 121607 1455	UN 22	37.95	S	177	15.40	E	GPS	4211	4211						1	25.2C
49MR0706_2	F14C	34	1	ROS 121607 1555	BO 22	37.56	S	177	15.51	E	GPS	4216	4216	10	4238	4266		30	1-8,27,32,34,84,86,87	
49MR0706_2	F14C	34	2	BUC 121607 1648	UN 22	37.36	S	177	15.58	E	GPS	4216	4216						34,86,87	PLANKTON NET
49MR0706_2	F14C	34	1	ROS 121607 1744	EN 22	37.18	S	177	15.65	E	GPS	4213	4214							
49MR0706_2	F14C	33	1	ROS 121607 1953	BE 23	3.92	S	177	11.05	E	GPS	4357	4357							
49MR0706_2	F14C	33	1	BUC 121607 2001	UN 23	3.90	S	177	11.08	E	GPS	4355	4355						1	25.1C
49MR0706_2	F14C	33	1	ROS 121607 2102	BO 23	3.90	S	177	10.94	E	GPS	4358	4359	8	4372	4414		30	1-8,23,24,26,27	
49MR0706_2	F14C	33	1	ROS 121607 2249	EN 23	3.70	S	177	10.92	E	GPS	4346	4346							
49MR0706_2	F14C	32	1	ROS 121707 0053	BE 23	29.25	S	177	6.87	E	GPS	4067	4066							
49MR0706_2	F14C	32	1	BUC 121707 0102	UN 23	29.21	S	177	6.83	E	GPS	4070	4069						1	25.1C
49MR0706_2	F14C	32	1	UNK 121707 0106	UN 23	29.20	S	177	6.82	E	GPS	4059	4059							20L THROUGH HULL PUMP FOR R.N.
49MR0706_2		675	1	UNK 121707 0117	UN 23	29.17	S	177	6.82	E	GPS	4037	4034							AIR SMPL FOR BVOC #34
49MR0706_2	F14C	32	1	ROS 121707 0201	BO 23	29.05	S	177	6.69	E	GPS	3997	3996	13	4014	4052		28	1-8,27	

Figure captions

Figure 1(a) Station locations for WHP-P01 cruise with bottom topography based on Smith and Sandwell (1997).

Figure 1(b) Station locations for WHP-P14 cruise with bottom topography based on Smith and Sandwell (1997).

Figure 2(a) Bathymetry measured by Multi Narrow Beam Echo Sounding system for WHP P01. Cross mark indicates CTD location.

Figure 2(b) Bathymetry measured by Multi Narrow Beam Echo Sounding system for WHP P14. Cross mark indicates CTD location.

Figure 3 Surface wind measured at 25 m above sea level. Wind data is averaged over 1-hour and plotted every 0.5 degree in latitude.
(a) WHP-P01 (b) WHP-P14

Figure 4 Sea surface temperature (SST). Temperature data is averaged over 1-hour.
(a) WHP-P01 (b) WHP-P14

Figure 5 Sea surface salinity (SSS). Salinity data is averaged over 1-hour.
(a) WHP-P01 (b) WHP-P14

Figure 6 Difference in the partial pressure of CO₂ between the ocean and the atmosphere, $\Delta p\text{CO}_2$.
(a) WHP-P01 (b) WHP-P14

Figure 7 Surface current at 100 m depth measured by ship board acoustic Doppler current profiler (ADCP).
(a) WHP-P01 (b) WHP-P14

Figure 8 Potential temperature ($^{\circ}\text{C}$) cross section calculated by using CTD temperature and salinity data calibrated by bottle salinity measurements. Vertical exaggeration of the 0-6,500 m section is 1000:1. Expanded section of the upper 1000 m is made with a vertical exaggeration of 2500:1.
(a) WHP-P01 (b) WHP-P14

Figure 9 CTD salinity (psu) cross section calibrated by bottle salinity measurements. Vertical exaggeration is same as Figure 8.
(a) WHP-P01 (b) WHP-P14

Figure 10 Same as Figure 9 but with SSW batch correction¹.
(a) WHP-P01 (b) WHP-P14

Figure 11 Density (σ_0) (kg/m^3) cross section calculated using CTD temperature and calibrated salinity data with SSW batch correction. Vertical exaggeration is same as Figure 8.
(a) WHP-P01 (b) WHP-P14

Figure 12 Same as Figure 11 but for σ_4 (kg/m^3).
(a) WHP-P01 (b) WHP-P14

Figure 13 Neutral density (γ^n) (kg/m^3) cross section calculated using CTD temperature and calibrated salinity data with SSW batch correction. Vertical exaggeration is same as Figure 8. (a) WHP-P01 (b) WHP-P14

Figure 14 Cross section of bottle sampled dissolved oxygen ($\mu\text{mol/kg}$). Data with quality flags of 2 were plotted. Vertical exaggeration is same as Figure 8.
(a) WHP-P01 (b) WHP-P14

Figure 15 Silicate ($\mu\text{mol/kg}$) cross section. Data with quality flags of 2 were plotted. Vertical exaggeration is same as Figure 8. (a) WHP-P01 (b) WHP-P14

- Figure 16 Nitrate ($\mu\text{mol/kg}$) cross section. Data with quality flags of 2 were plotted. Vertical exaggeration of the upper 1000 m section is same as Figure 8. (a) WHP-P01 (b) WHP-P14
- Figure 17 Nitrite ($\mu\text{mol/kg}$) cross section. Data with quality flags of 2 were plotted. Vertical exaggeration is same as Figure 8. (a) WHP-P01 (b) WHP-P14
- Figure 18 Phosphate ($\mu\text{mol/kg}$) cross section. Data with quality flags of 2 were plotted. Vertical exaggeration is same as Figure 8. (a) WHP-P01 (b) WHP-P14
- Figure 19 Dissolved inorganic carbon ($\mu\text{mol/kg}$) cross section. Data with quality flags of 2 were plotted. Vertical exaggeration is same as Figure 8. (a) WHP-P01 (b) WHP-P14
- Figure 20 Total alkalinity ($\mu\text{mol/kg}$) cross section. Data with quality flags of 2 were plotted. Vertical exaggeration is same as Figure 8. (a) WHP-P01 (b) WHP-P14
- Figure 21 pH cross section. Data with quality flags of 2 were plotted. Vertical exaggeration is same as Figure 8. (a) WHP-P01 (b) WHP-P14
- Figure 22 CFC-11 (pmol/kg) cross section. Data with quality flags of 2 were plotted. Vertical exaggeration is same as Figure 8. (a) WHP-P01 (b) WHP-P14
- Figure 23 CFC-12 (pmol/kg) cross section. Data with quality flags of 2 were plotted. Vertical exaggeration is same as Figure 8. (a) WHP-P01 (b) WHP-P14
- Figure 24 CFC-113 (pmol/kg) cross section. Data with quality flags of 2 were plotted. Vertical exaggeration is same as Figure 8. (a) WHP-P01 (b) WHP-P14
- Figure 25 Cross section of current velocity (cm/s) normal to the cruise track measured by LADCP (northward is positive). (a) WHP-P01 (b) WHP-P14

- Figure 26 Difference in potential temperature ($^{\circ}\text{C}$) between results from WOCE (from Oct. to Nov., 1993) and the revisit cruise (from May to Jul., 2005). Red and blue areas show the areas where potential temperature increased and decreased in the revisit cruise, respectively. On white areas differences in temperature do not exceed the detection limit of 0.002°C . Vertical exaggeration is same as Figure 8. (a) WHP-P01 (b) WHP-P14
- Figure 27 Difference in salinity (psu) between results from WOCE and the revisit cruise. Red and blue areas show the areas where salinity increased and decreased in the revisit cruise, respectively. CTD salinity data with SSW batch correction¹ are used. On white areas differences in salinity do not exceed the detection limit of 0.002 psu. Vertical exaggeration is same as Figure 8. (a) WHP-P01 (b) WHP-P14
- Figure 28 Difference in dissolved oxygen ($\mu\text{mol/kg}$) between results from WOCE and the revisit cruise. Red and blue areas show the areas where salinity increased and decreased in the revisit cruise, respectively. Bottle oxygen data are used. On white areas differences in salinity do not exceed the detection limit of 2 $\mu\text{mol/kg}$. Vertical exaggeration is same as Figure 8. (a) WHP-P01 (b) WHP-P14

Note

1. As for the traceability of SSW to Mantyla's value, the offset for the batches P120 (P14C), P122 (P14N), P133 (P01E and P01W), P134 (P01C, a part of P01E and P01H) and P148 (Revisit) is -0.0022 , -0.0009 , -0.0010 , -0.0011 and -0.0011 , respectively (The newest values, Kawano et al., in preparation).

References

- Jackett, D. R. and R. J. McDougall (1997): A neutral density variable for the world's oceans, *Journal of Physical Oceanography*, 27, 237-263.
- Smith, W. H. F. and D. T. Sandwell (1997): Global seafloor topography from satellite altimetry and ship depth soundings, *Science*, 277, 1956-1962.

Figure 1(a)
Station locations for WHP-P01 cruise

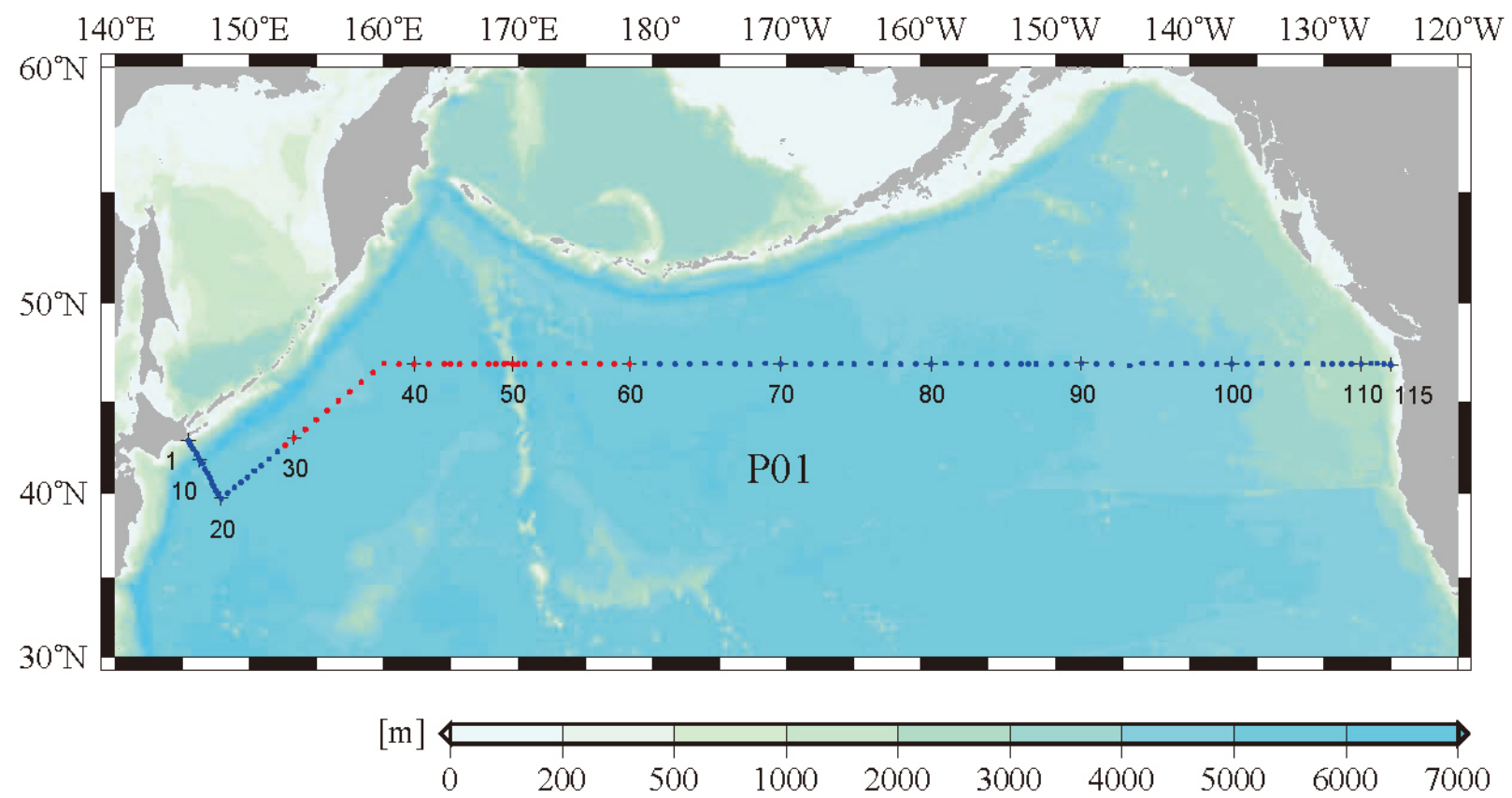

Figure 1(b)
Station locations
for WHP-P14 cruise

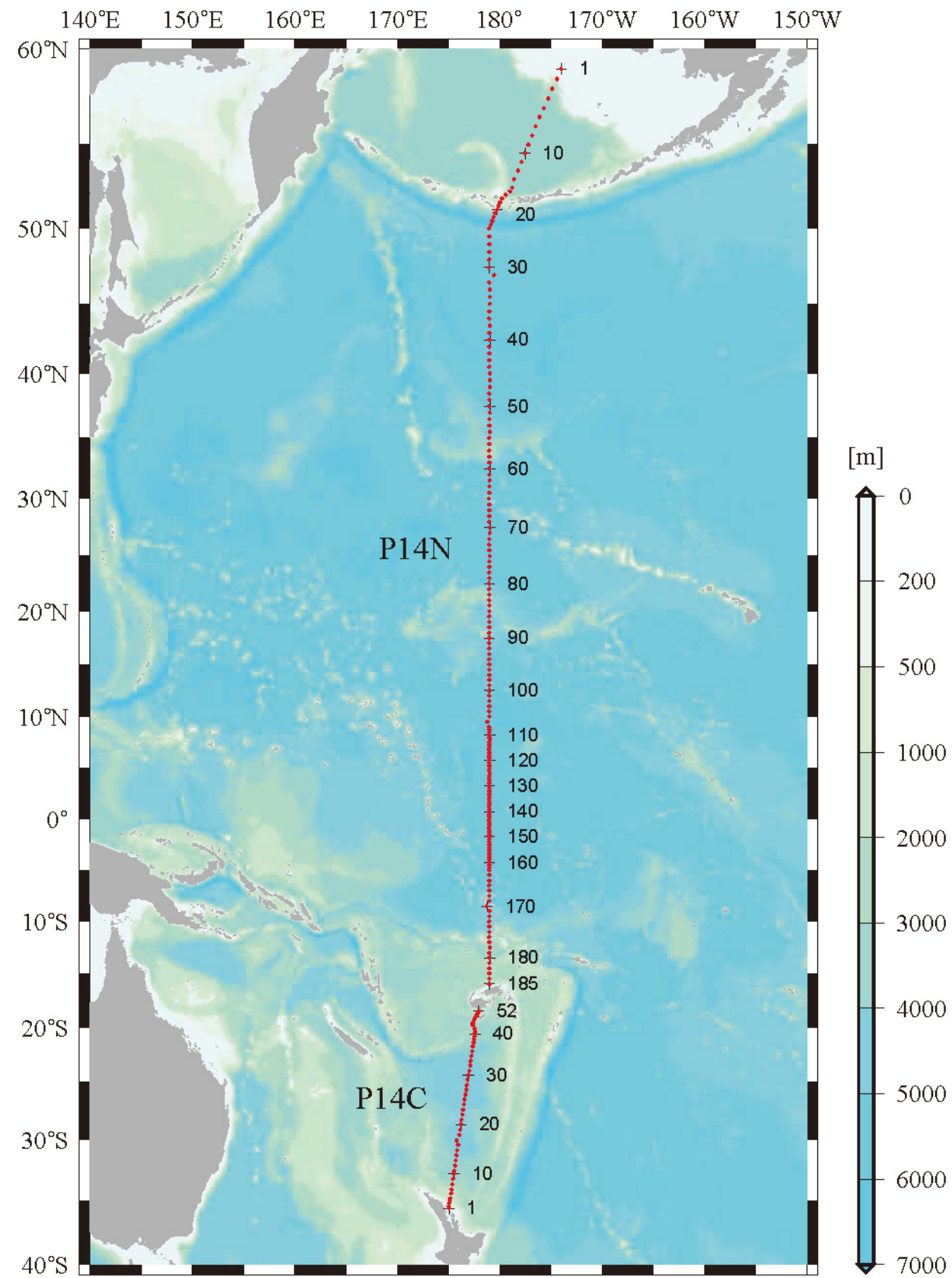

Figure 2(a)

Bathymetry measured by Multi Narrow Beam Echo Sounding system for WHP-P01

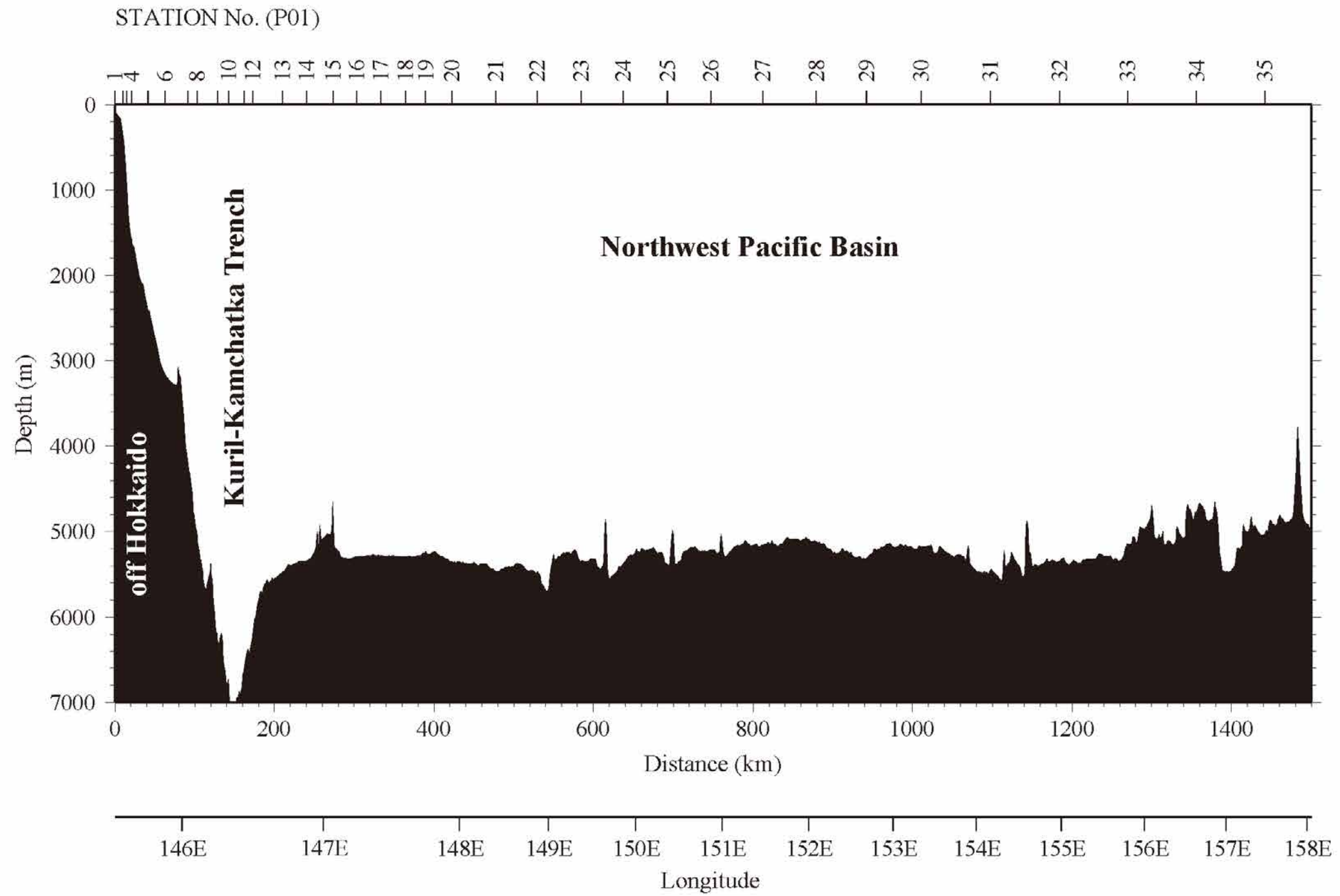

Figure 2(a)
Continued

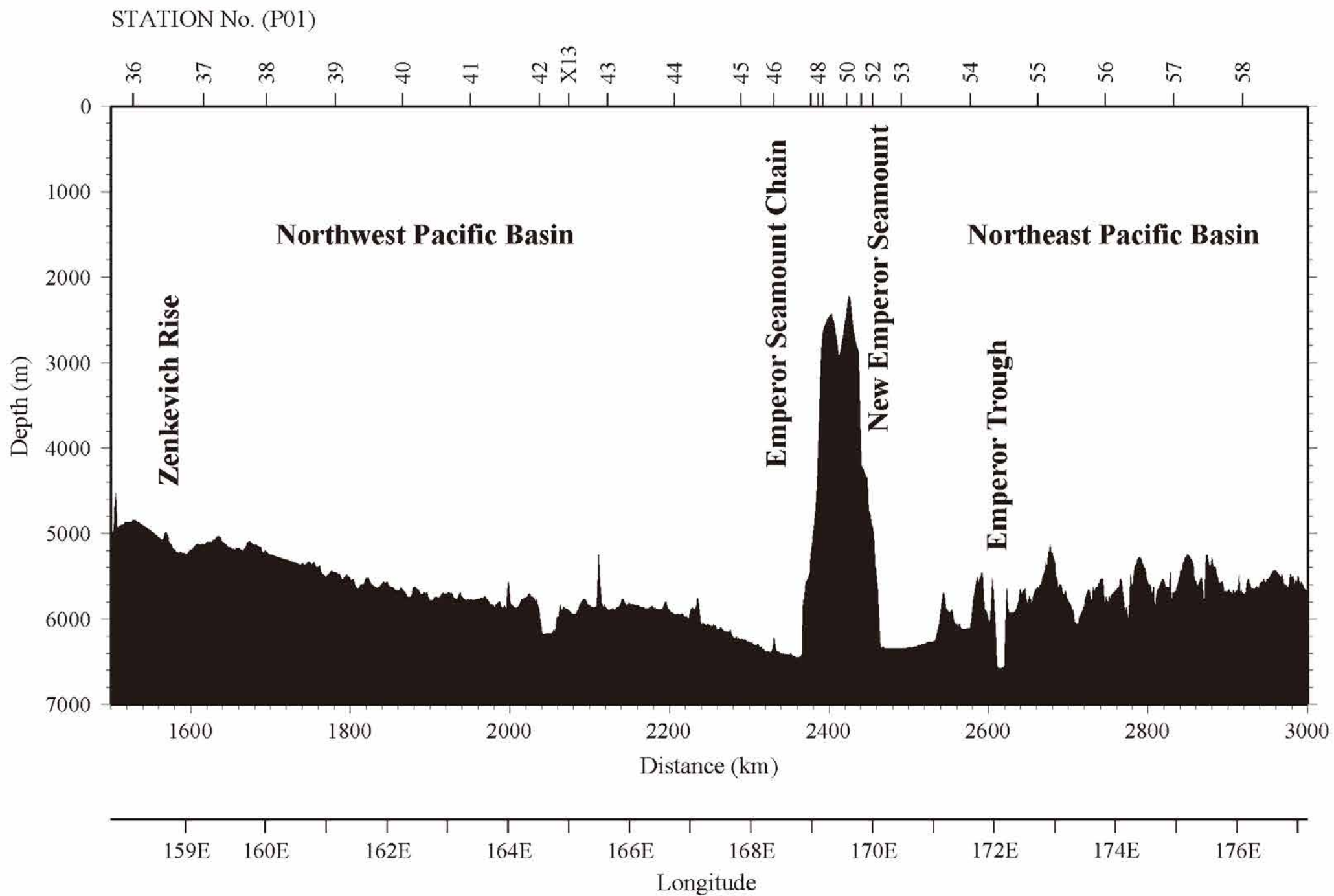

Figure 2(a)
Continued

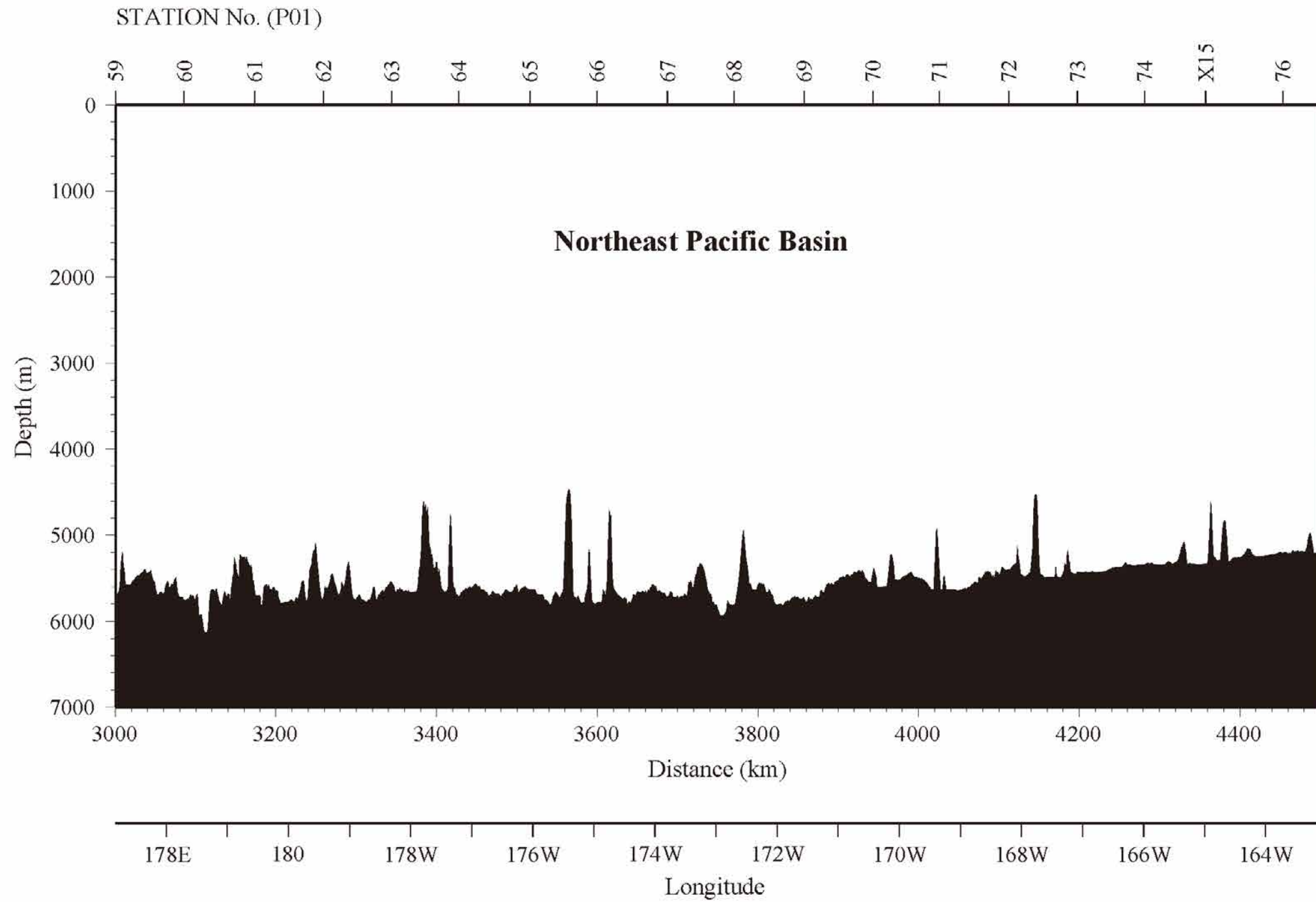

Figure 2(a)
Continued

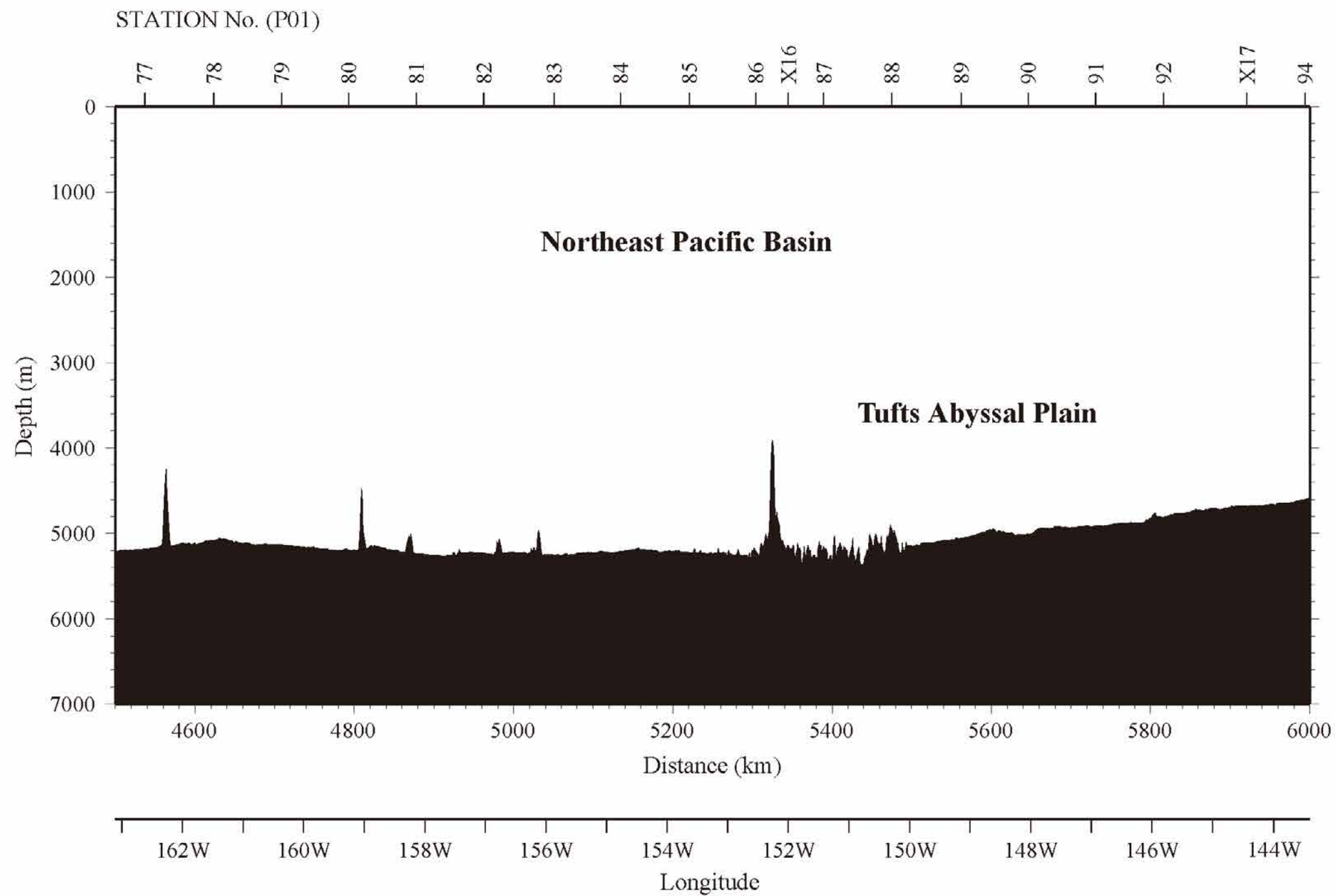

Figure 2(a)
Continued

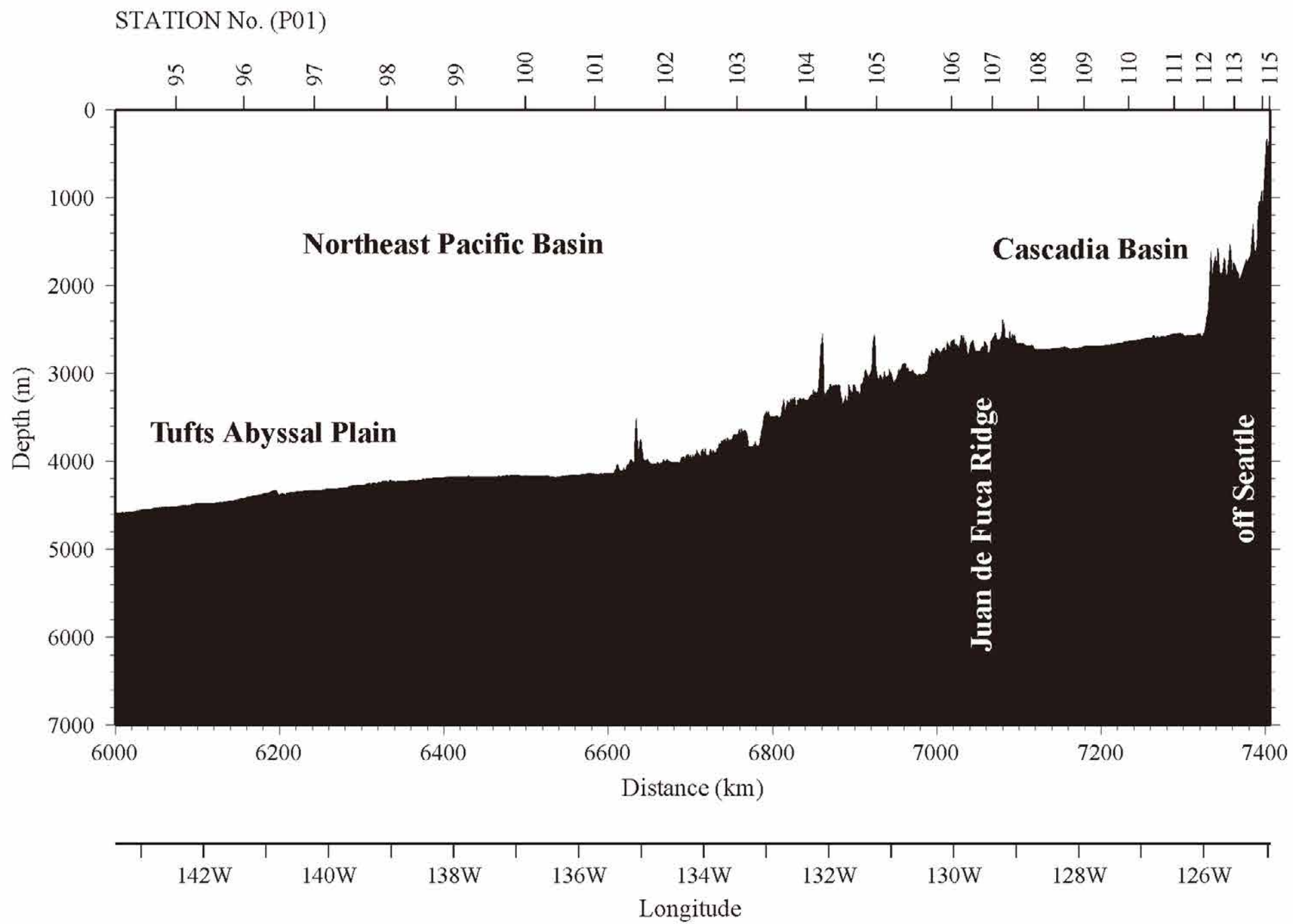

Figure 2(b)

Bathymetry measured by Multi Narrow Beam Echo Sounding System for WHP-P14

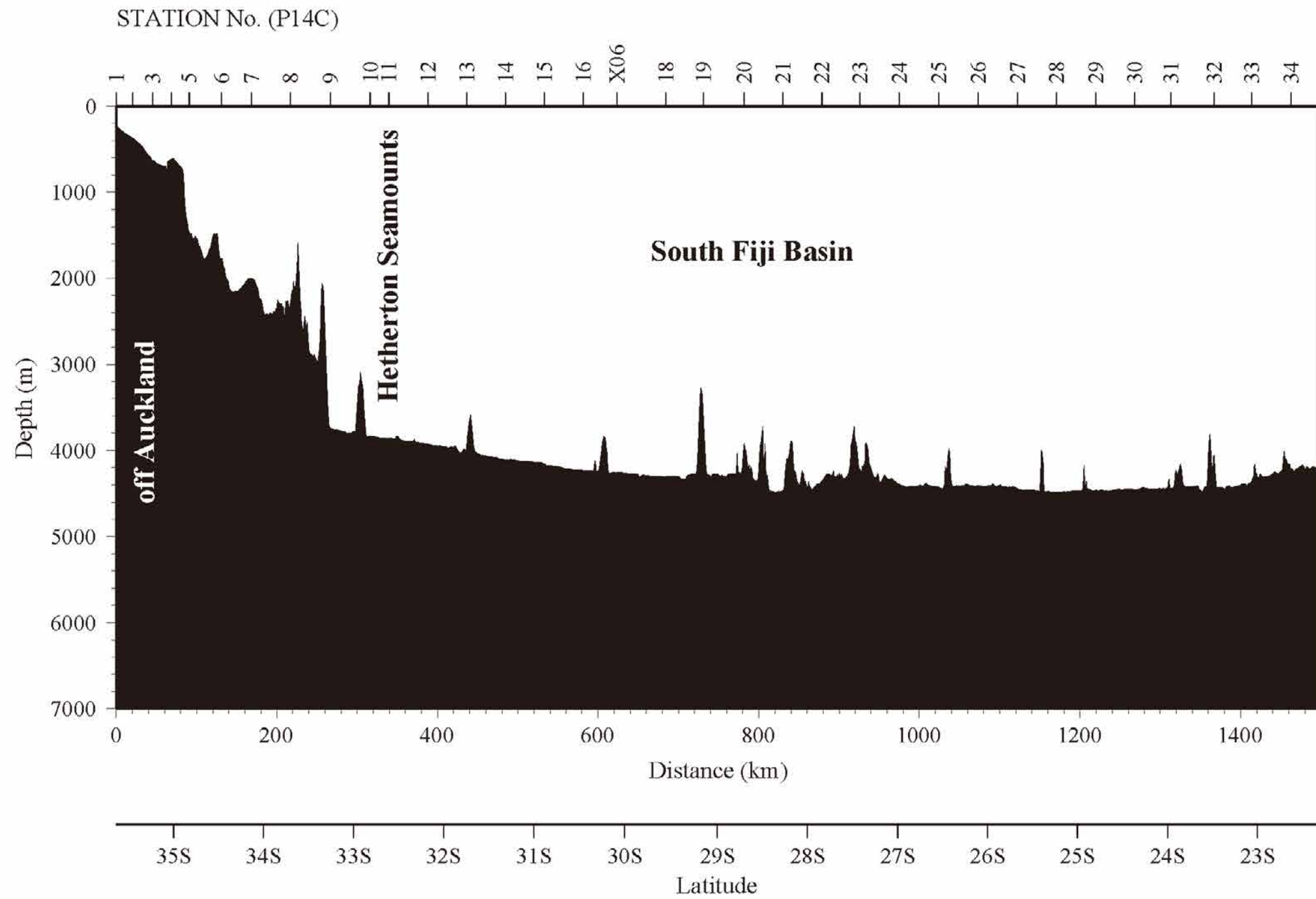

Figure 2(b)
Continued

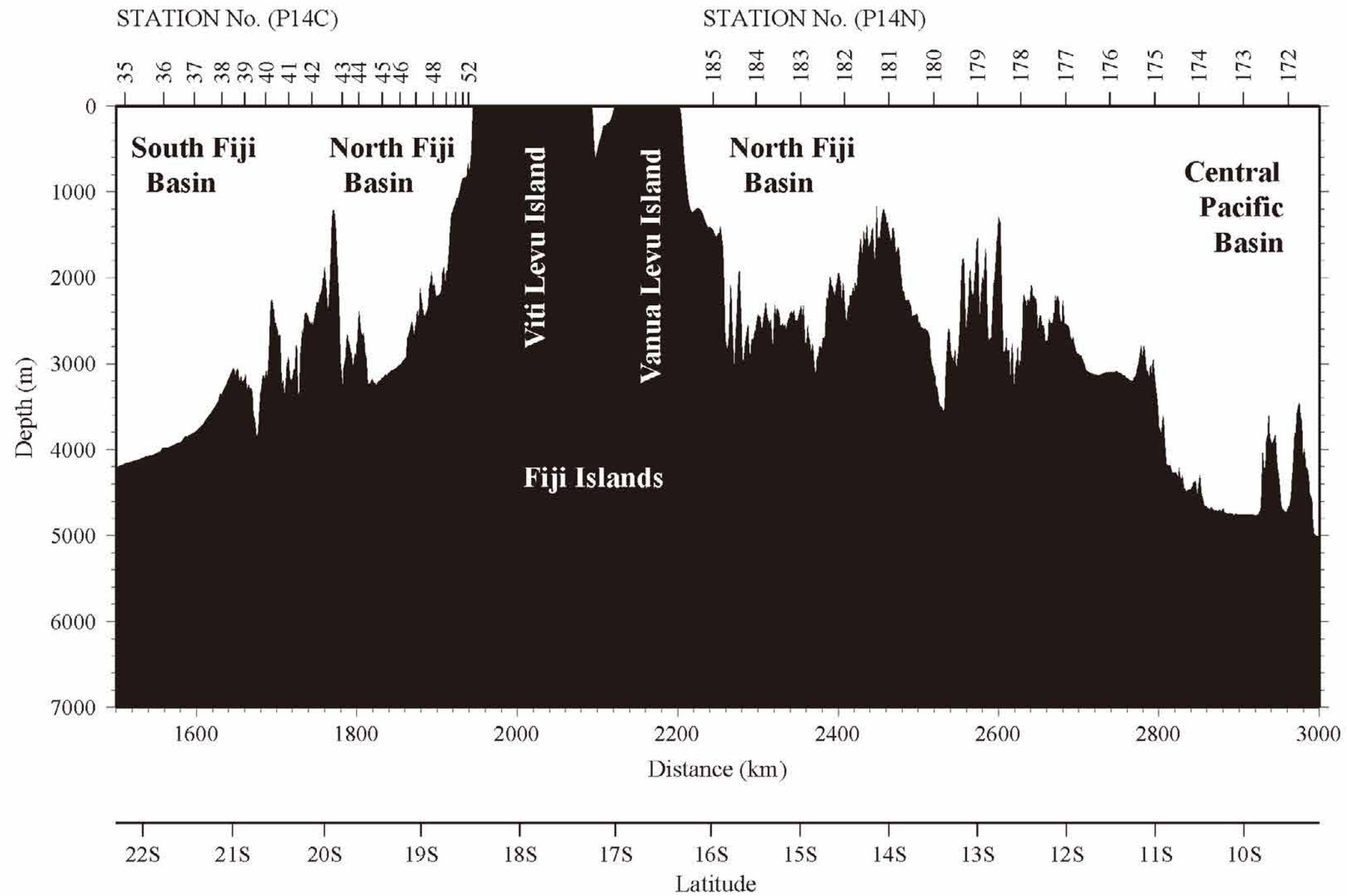

Figure 2(b)
Continued

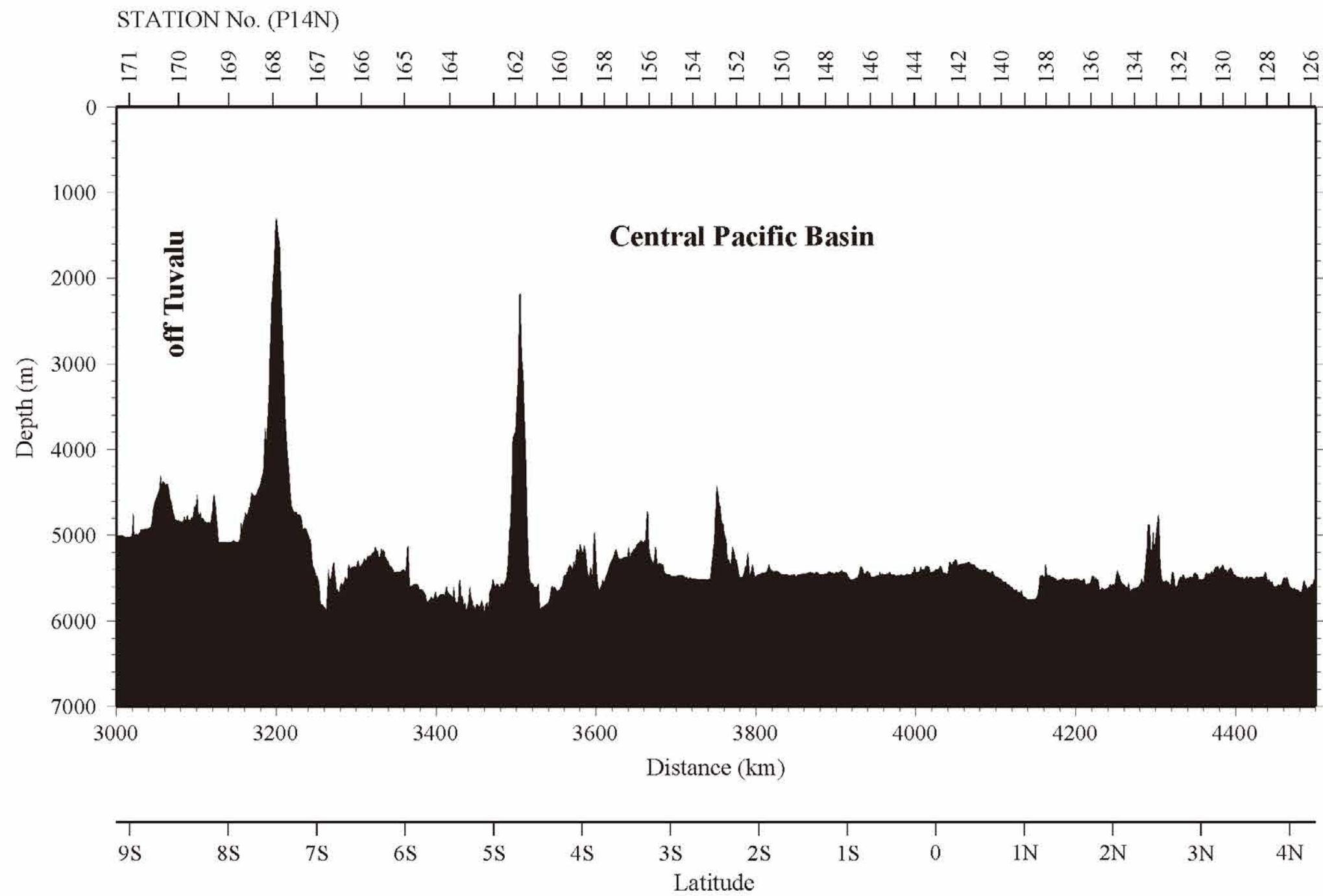

Figure 2(b)
Continued

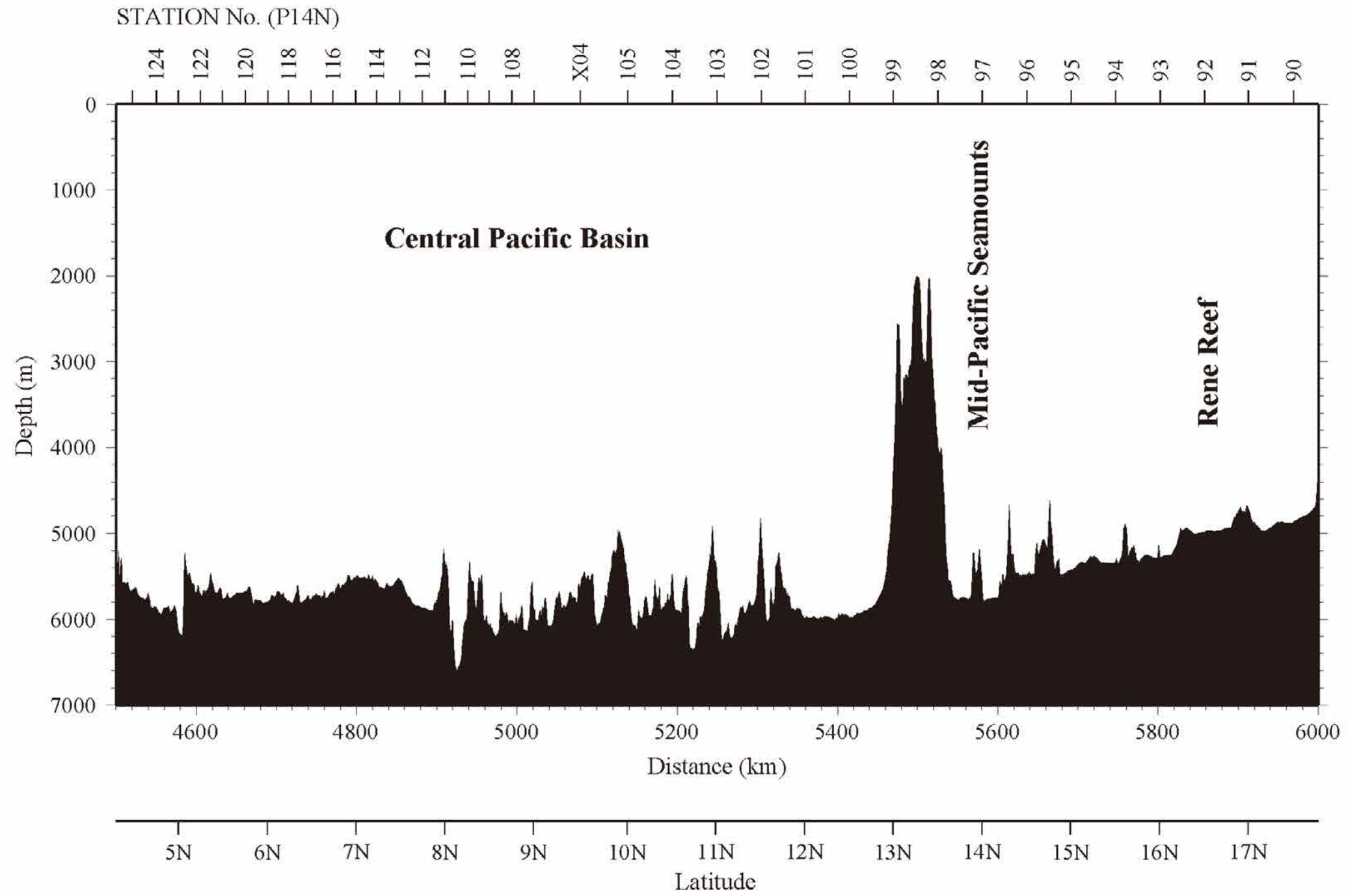

Figure 2(b)
Continued

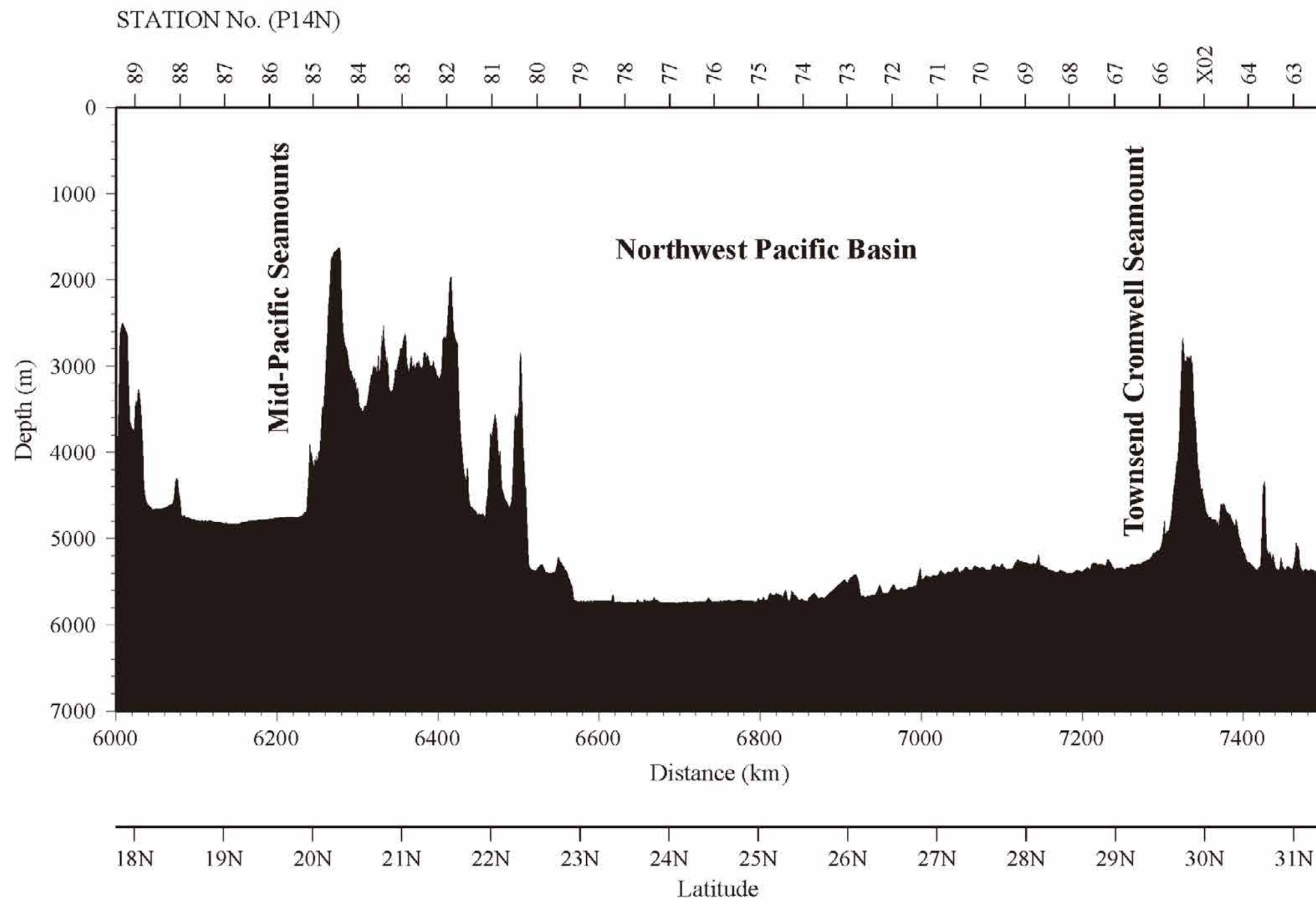

Figure 2(b)
Continued

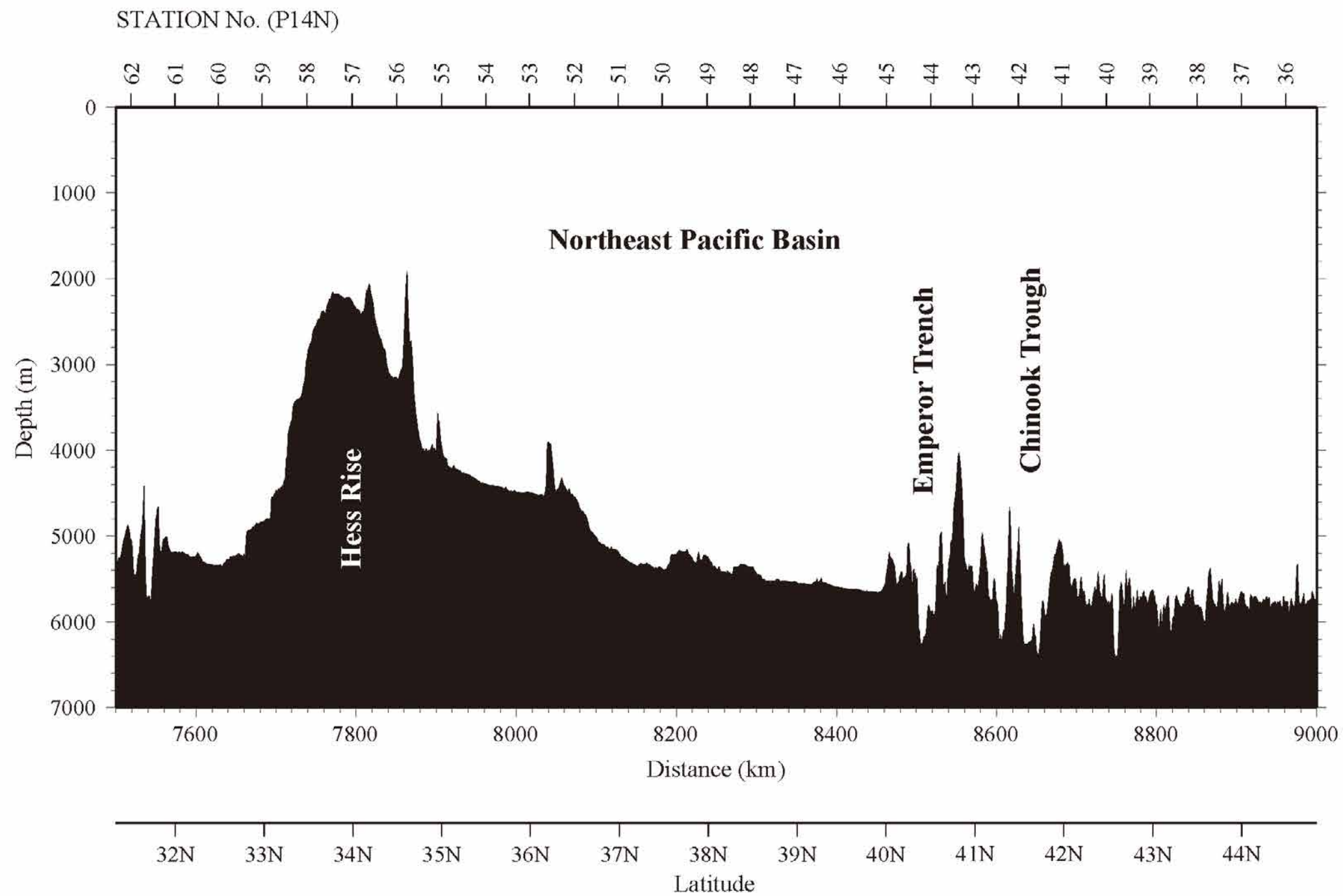

Figure 2(b)
Continued

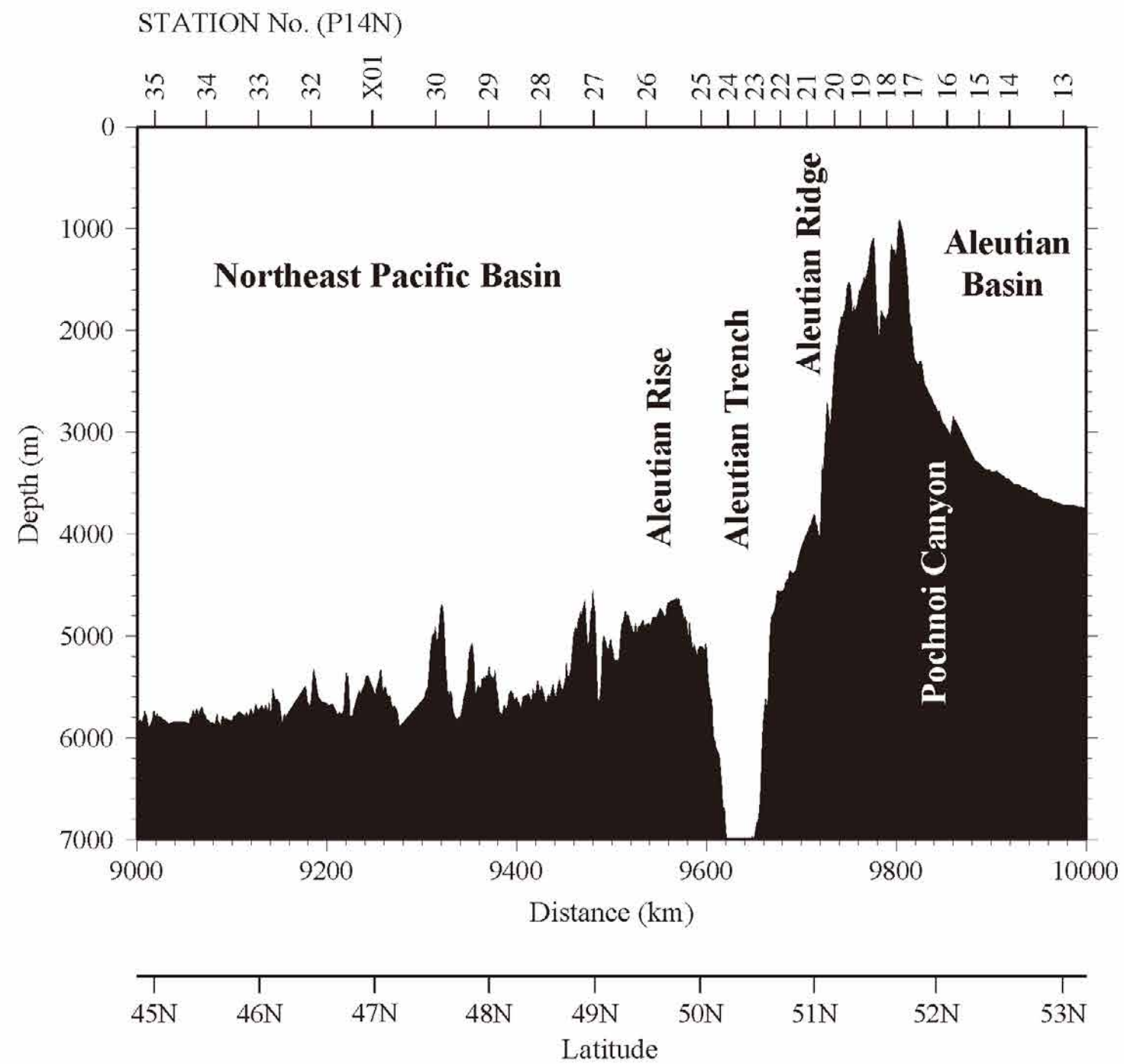

Figure 2(b)
Continued

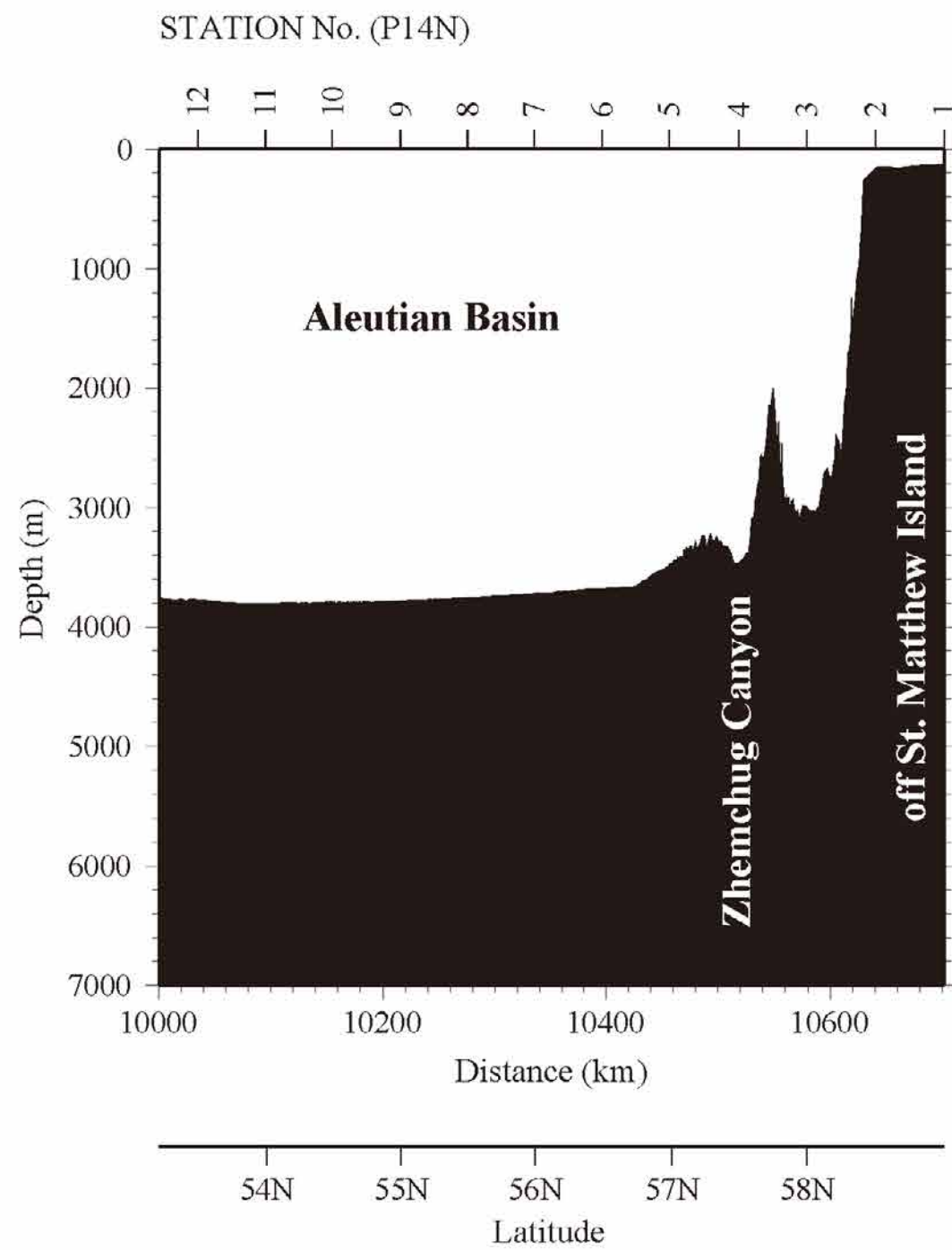
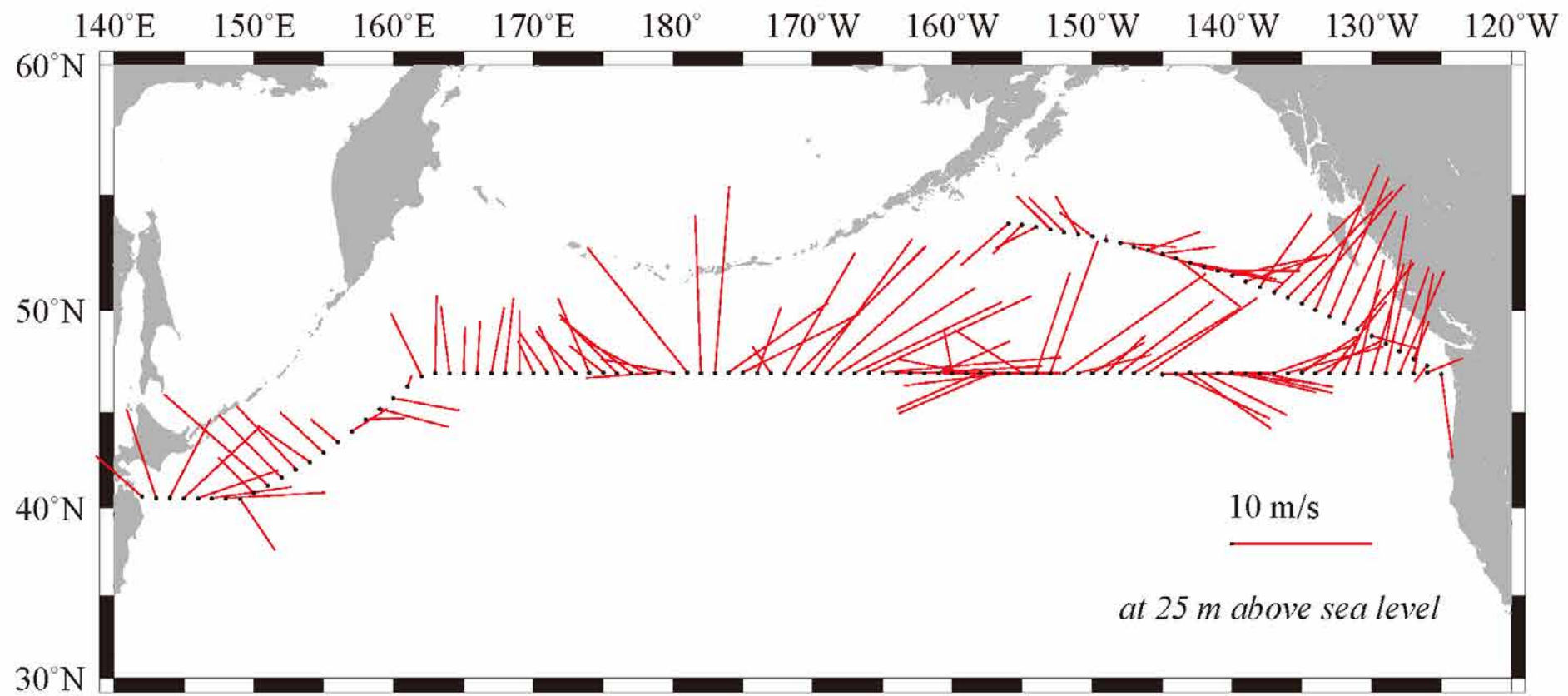

Figure 3
Surface wind measured at 25 m above sea level
(a) WHP-P01



(b) WHP-P14

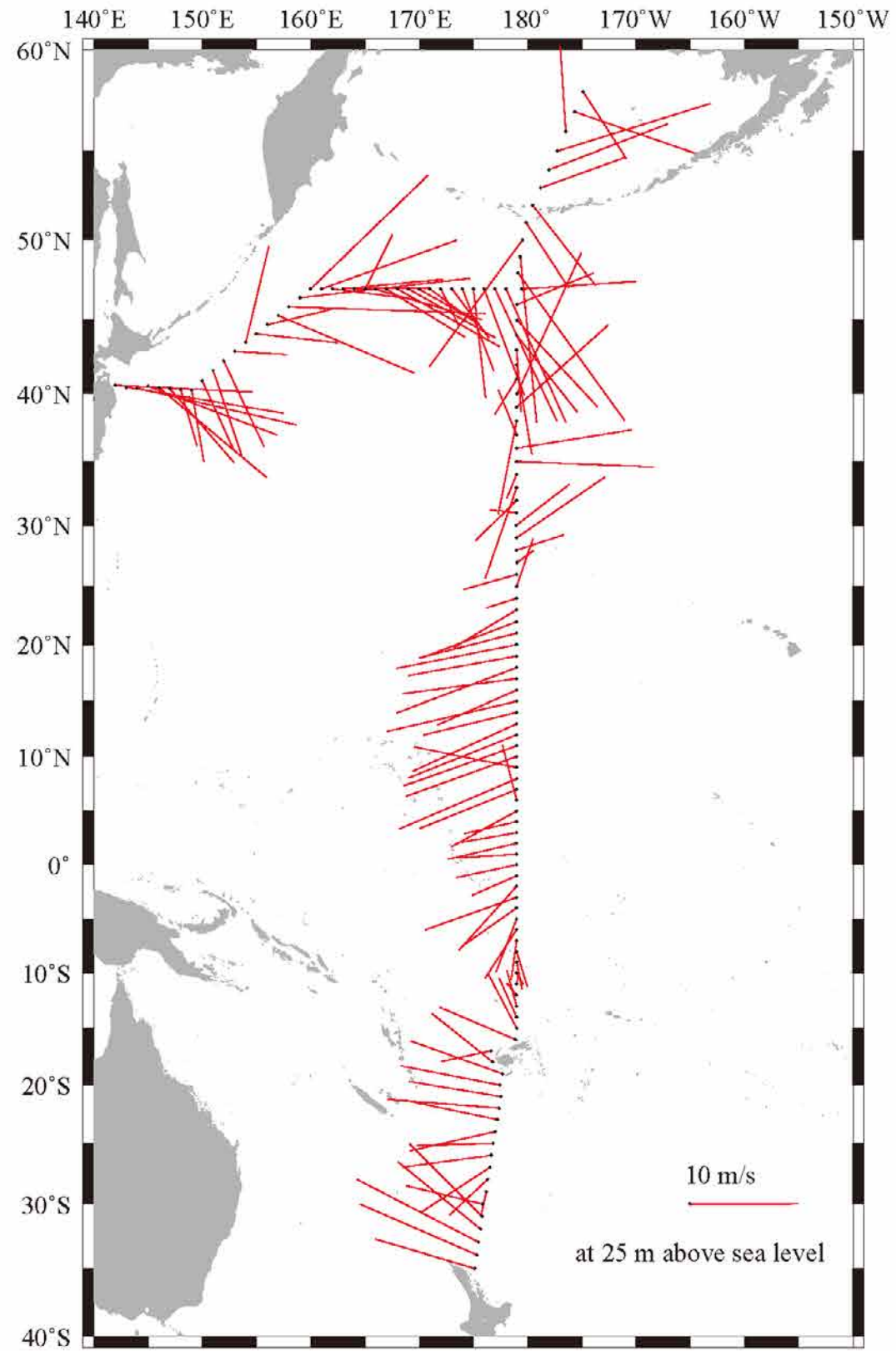
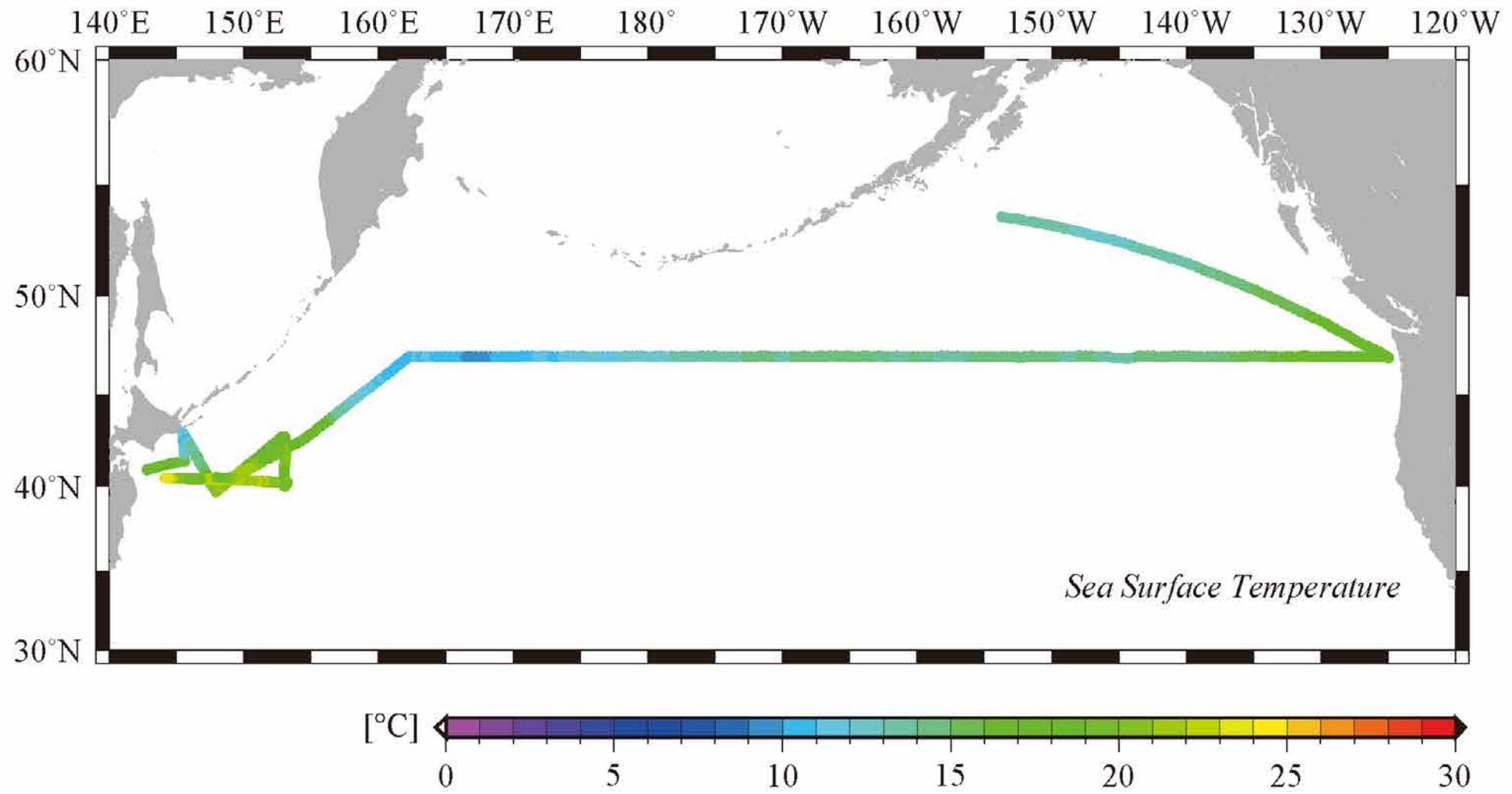

Figure 4
Sea surface temperature (SST)
(a) WHP-P01



(b) WHP-P14

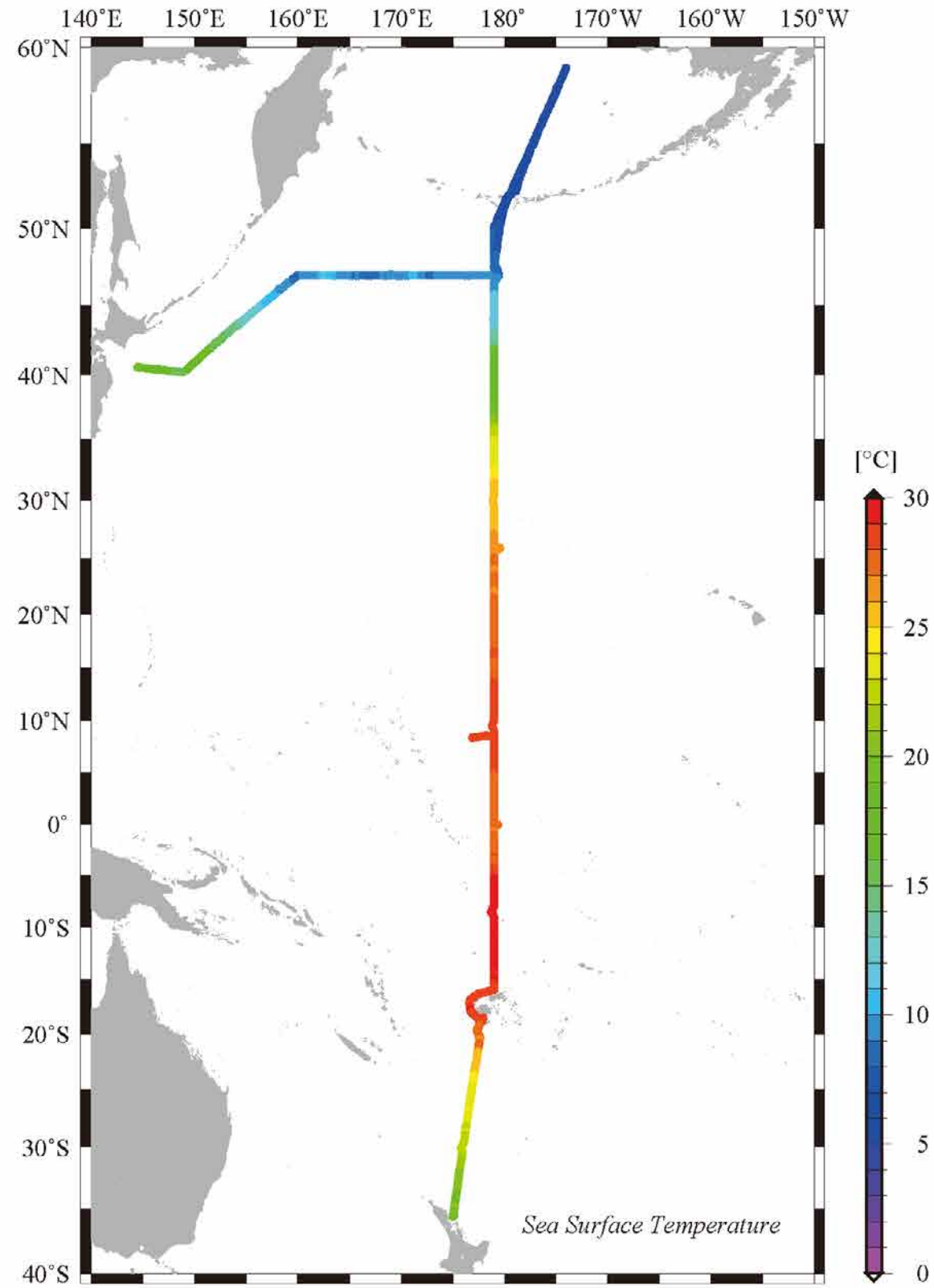
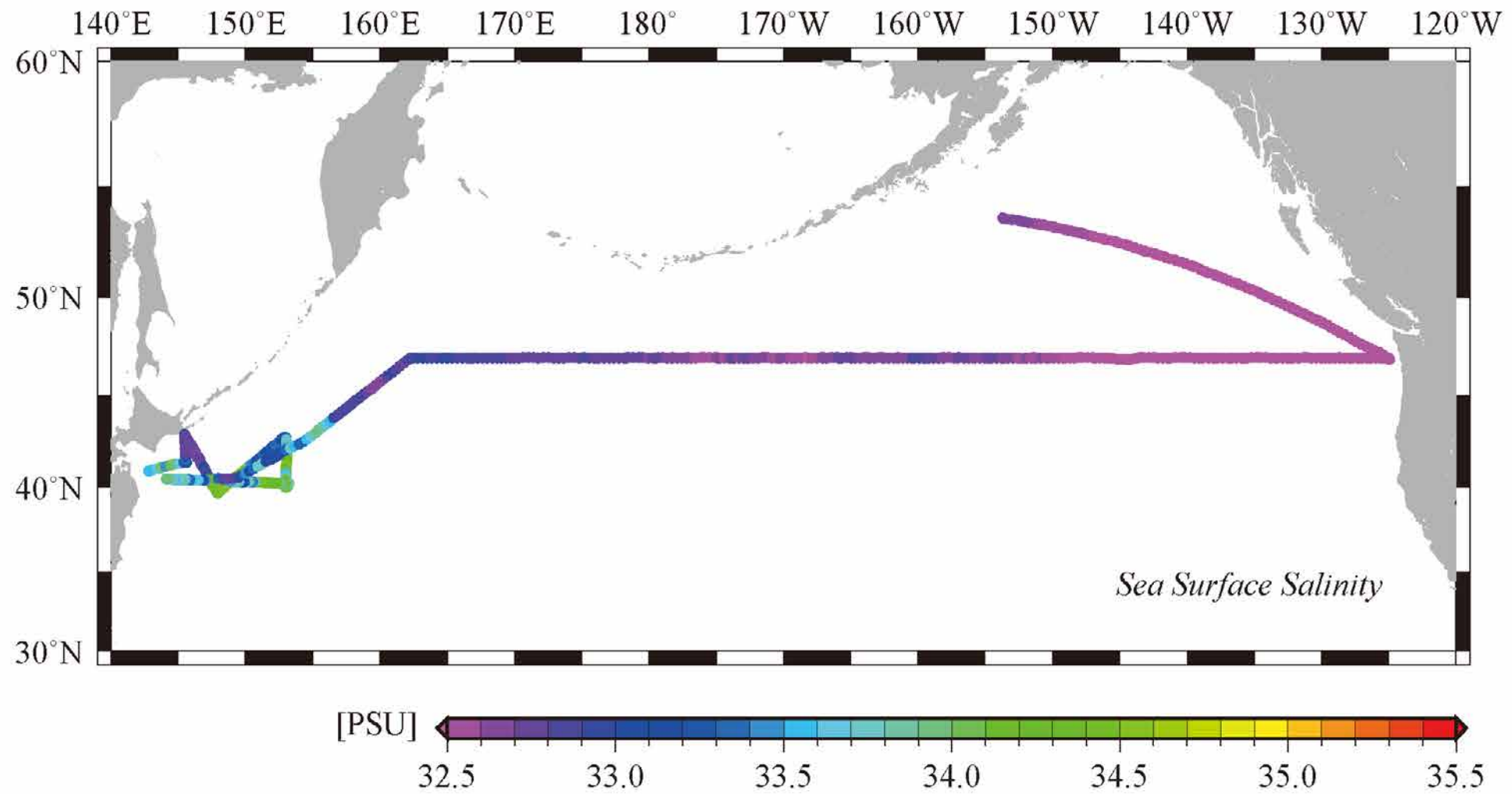

Figure 5
Sea surface salinity (SSS)
(a) WHP-P01



(b) WHP-P14

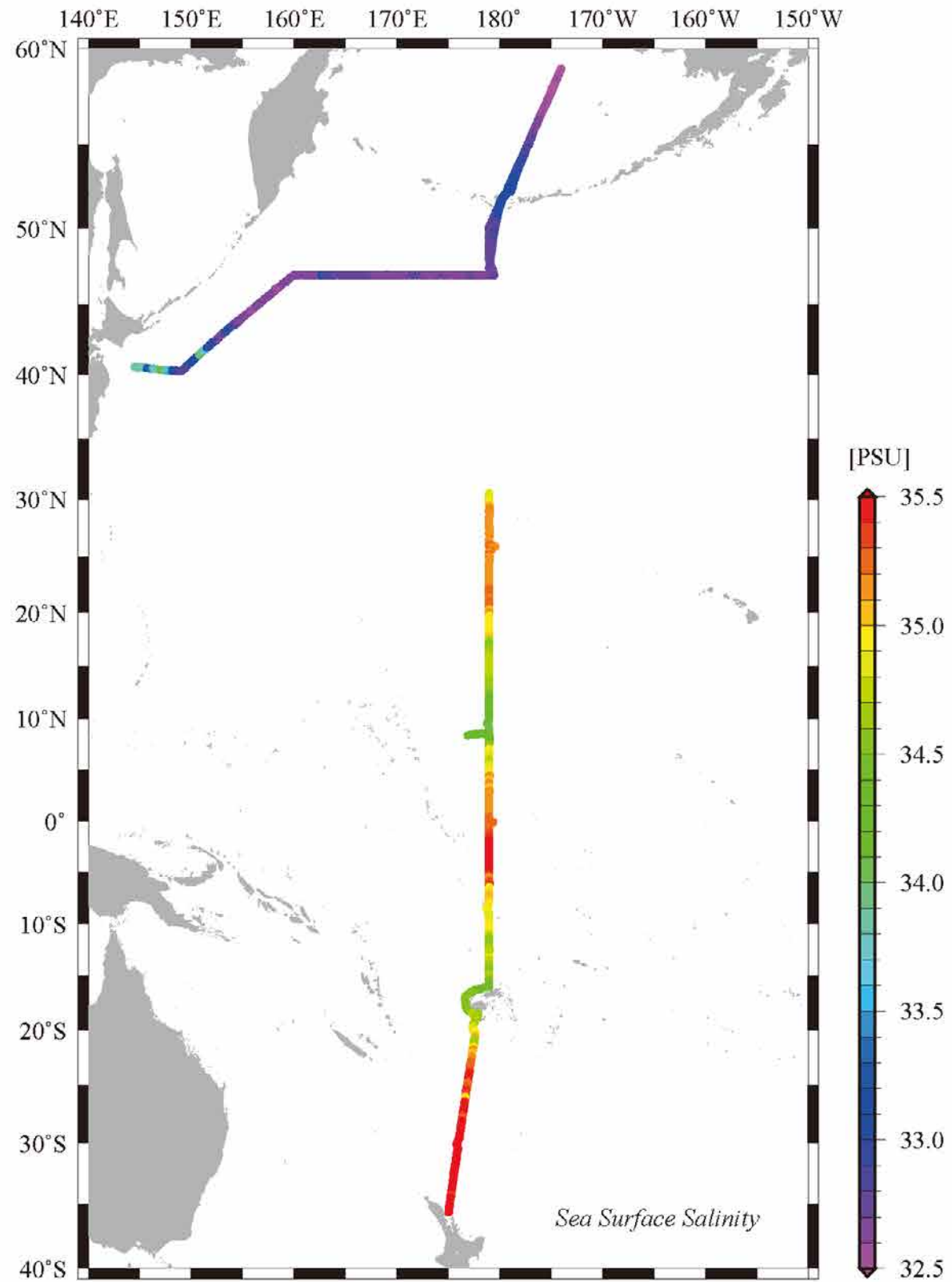
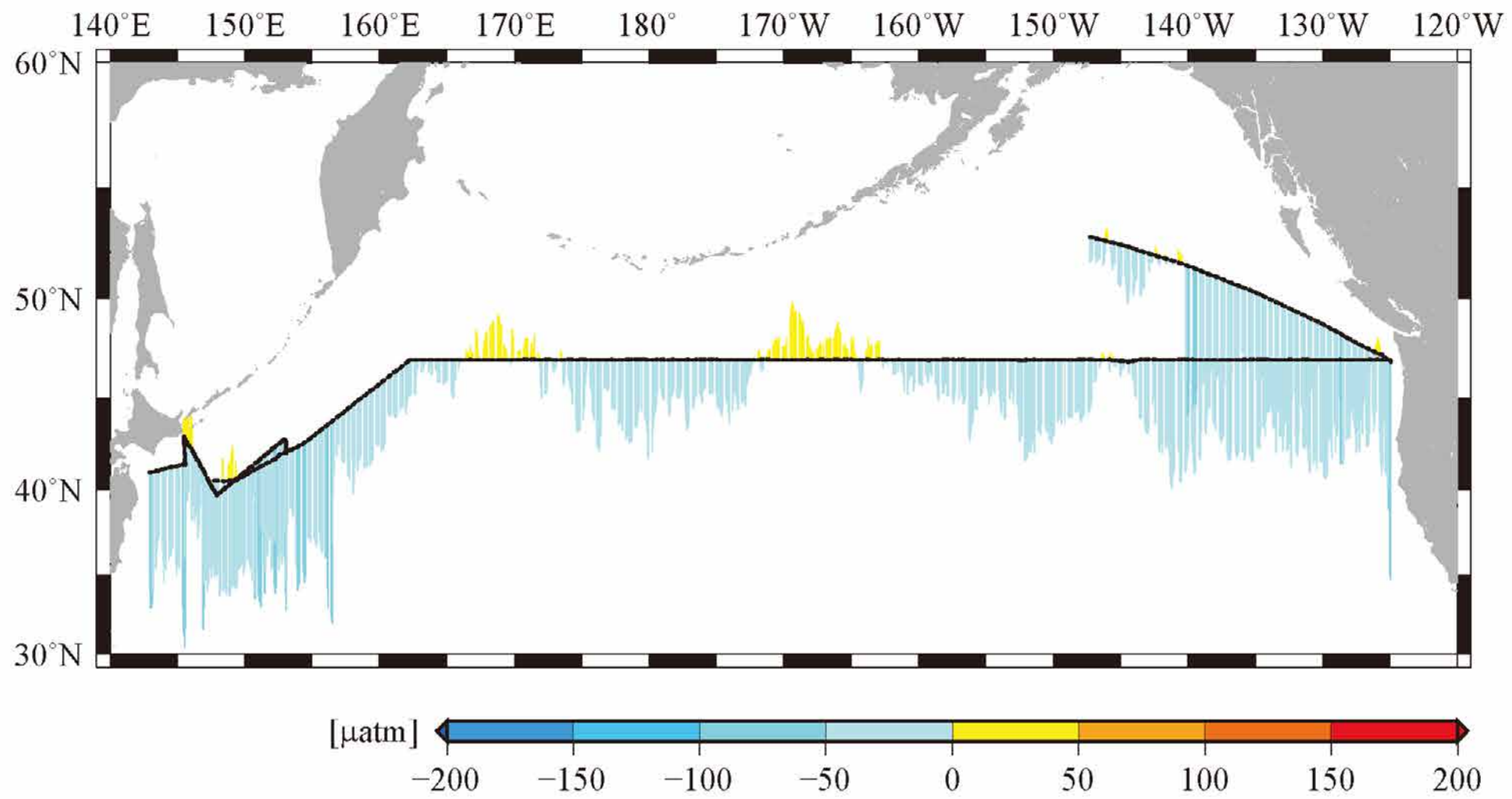

Figure 6
 $\Delta p\text{CO}_2$
(a) WHP-P01



(b) WHP-P14

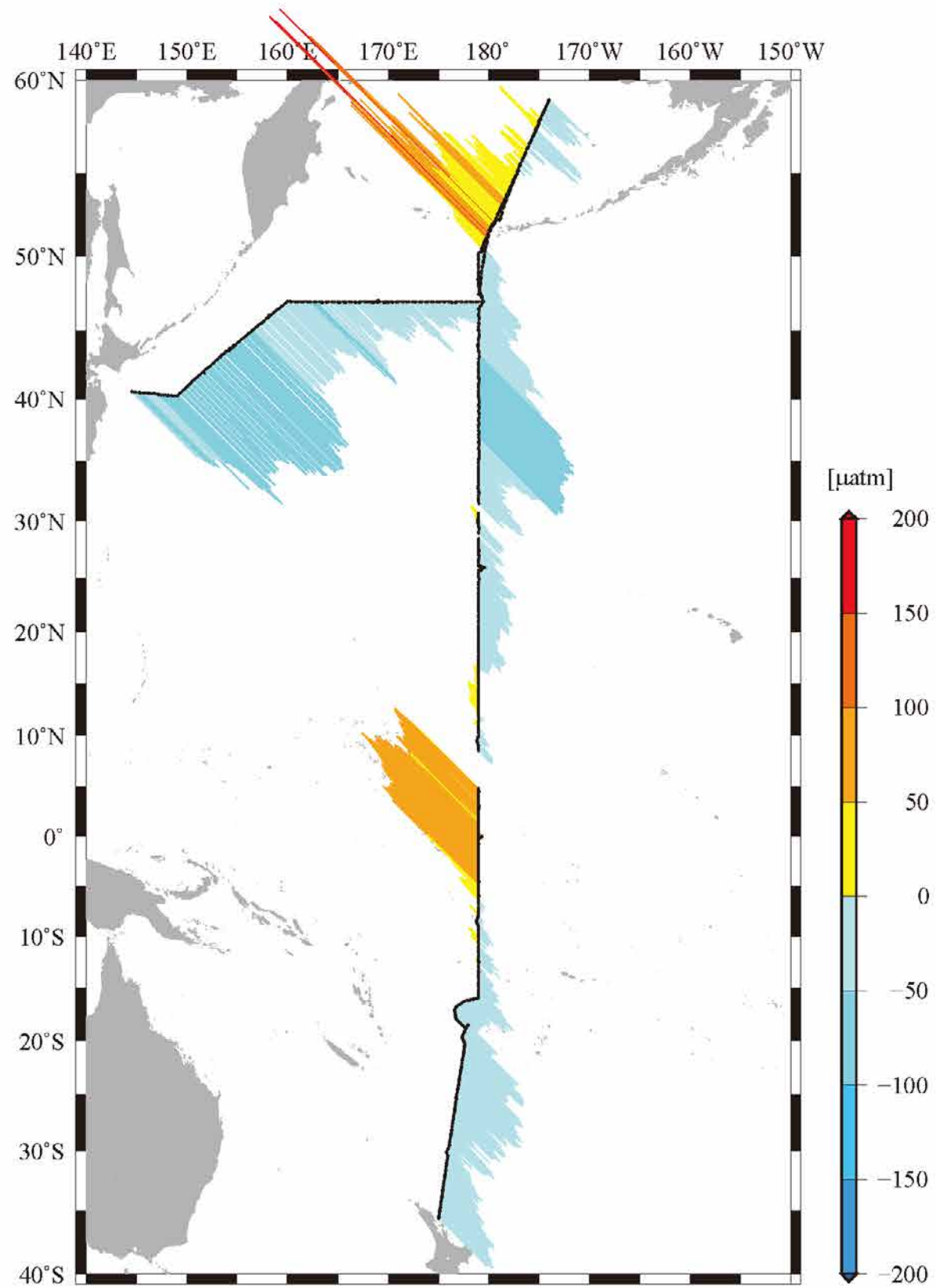
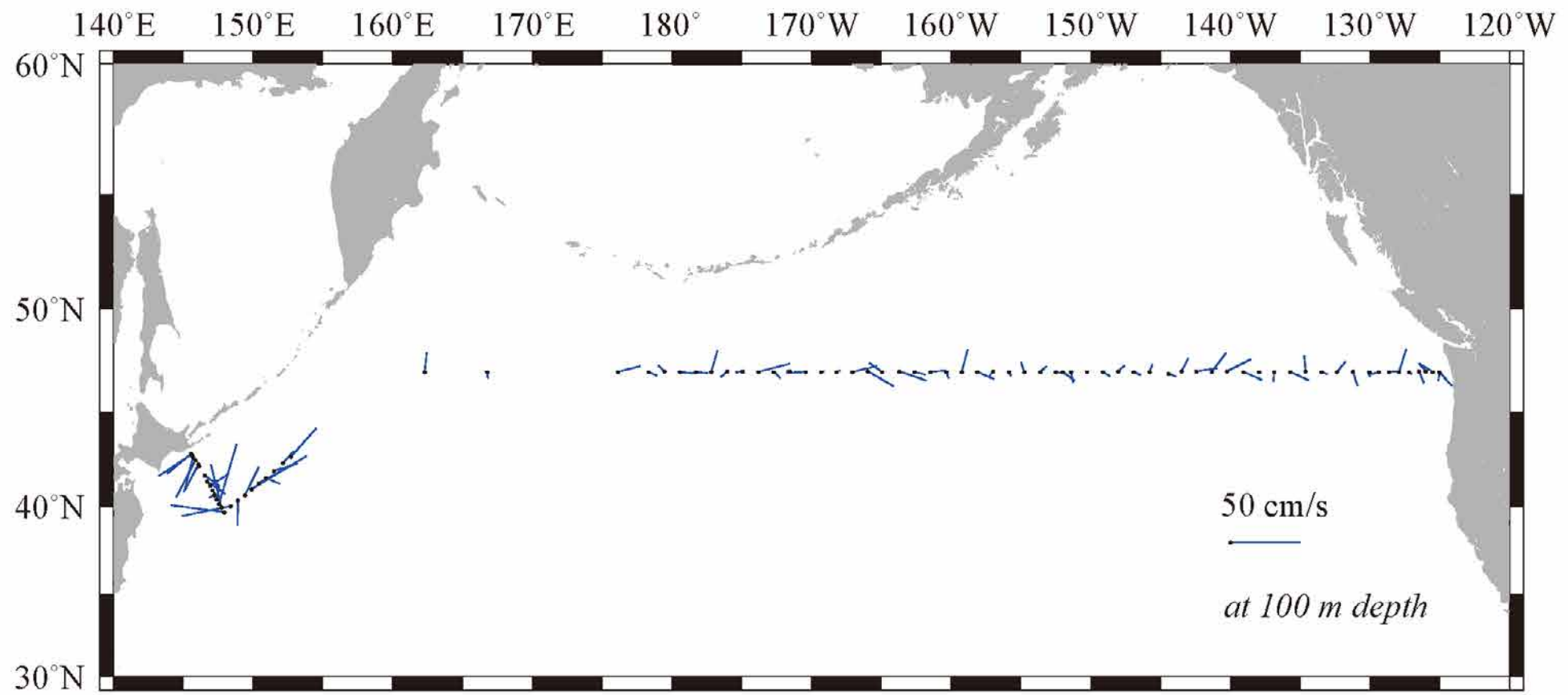

Figure 7
Surface current measured by shipboard ADCP
(a) WHP-P01



(b) WHP-P14

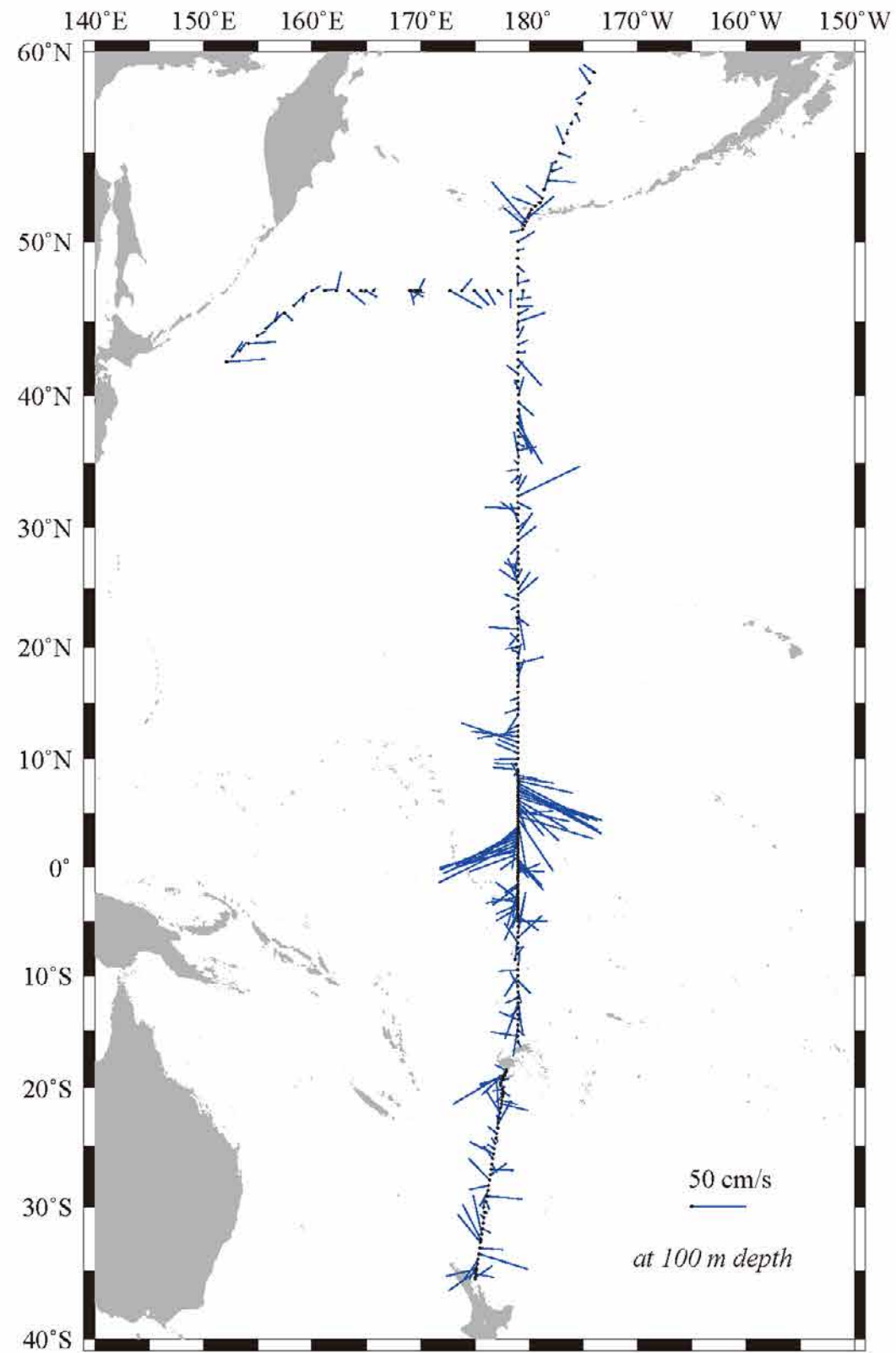
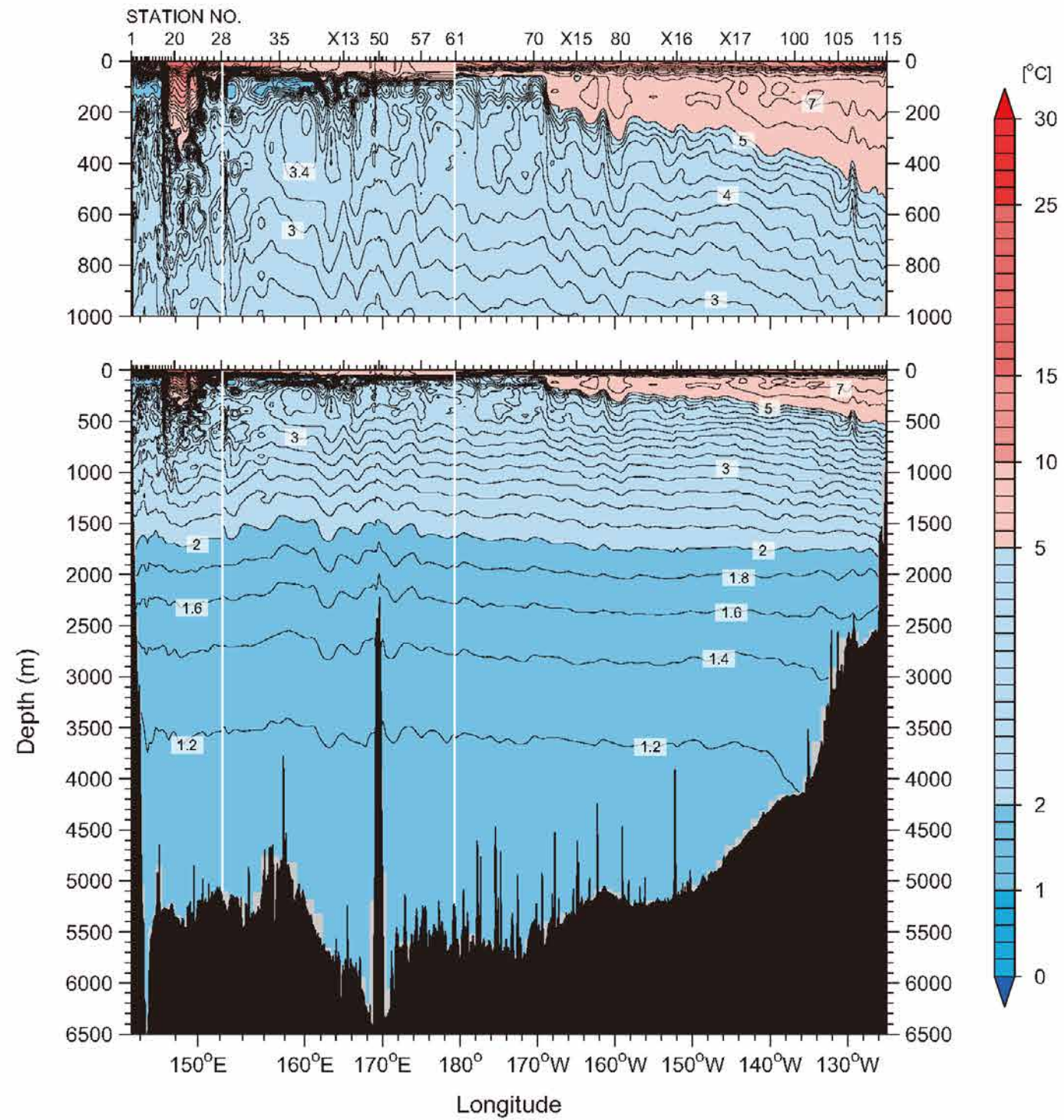

Figure 8
Potential temperature (°C)
(a) WHP-P01



(b) WHP-P14

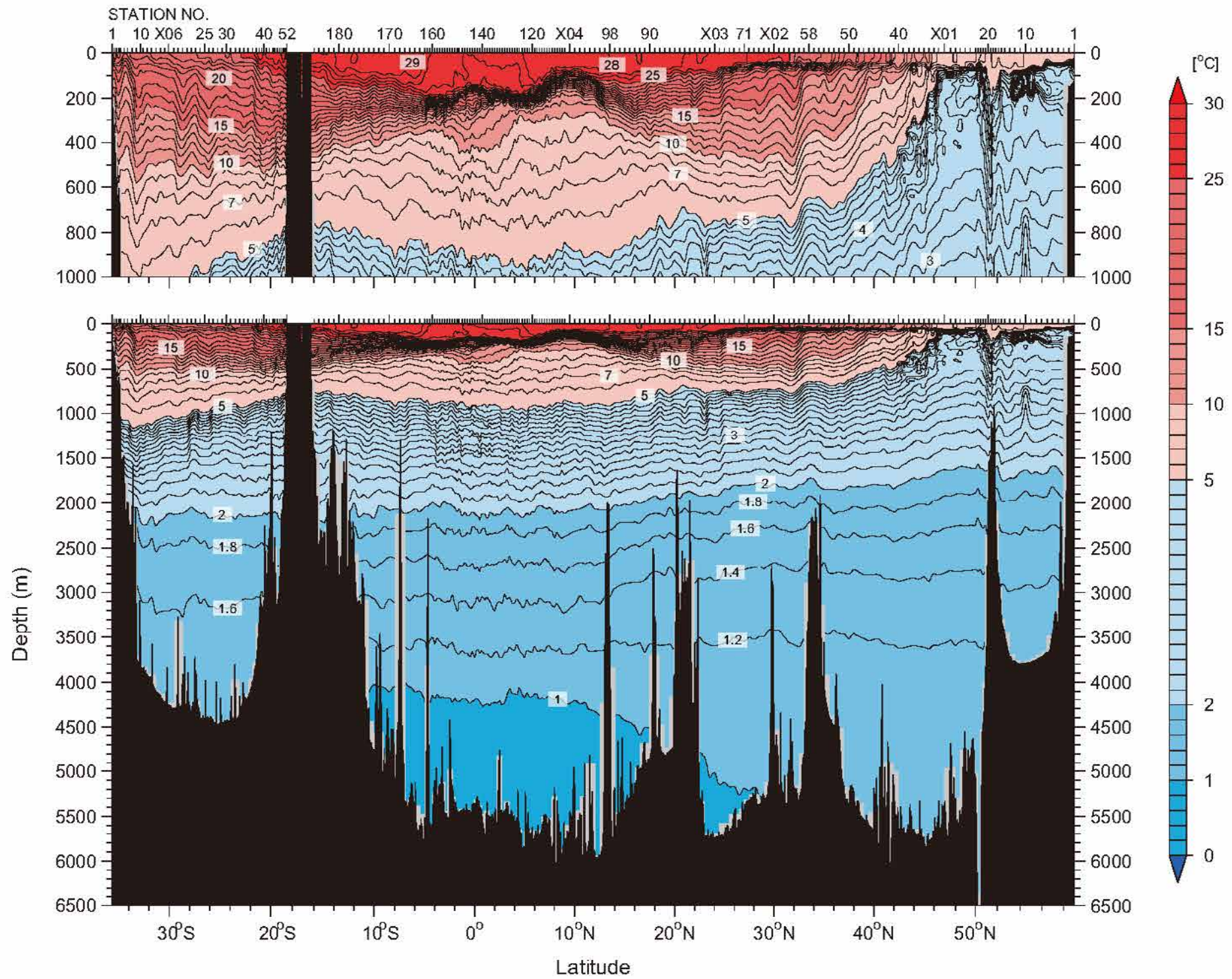
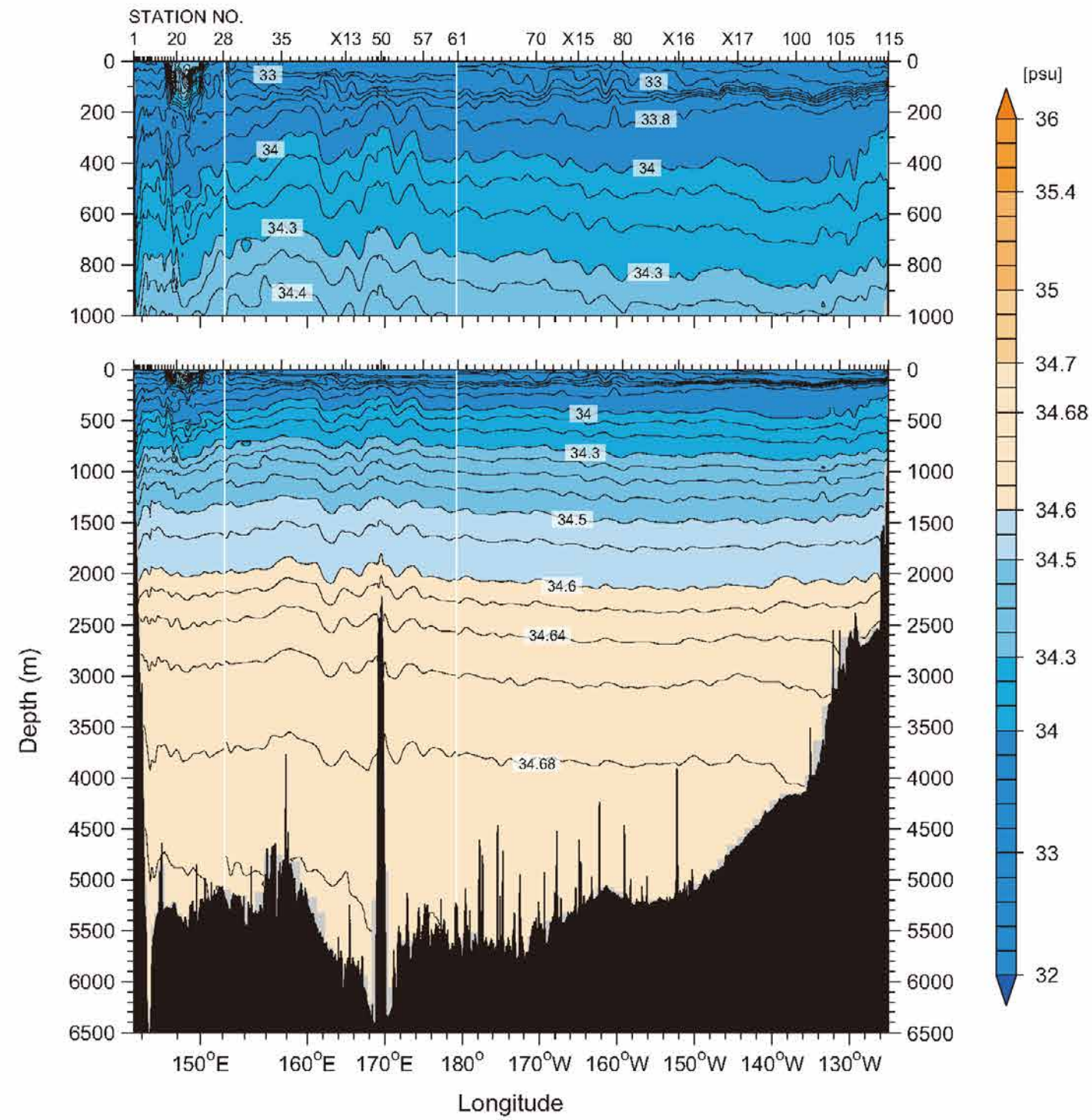

Figure 9
CTD salinity (psu)
(a) WHP-P01



(b) WHP-P14

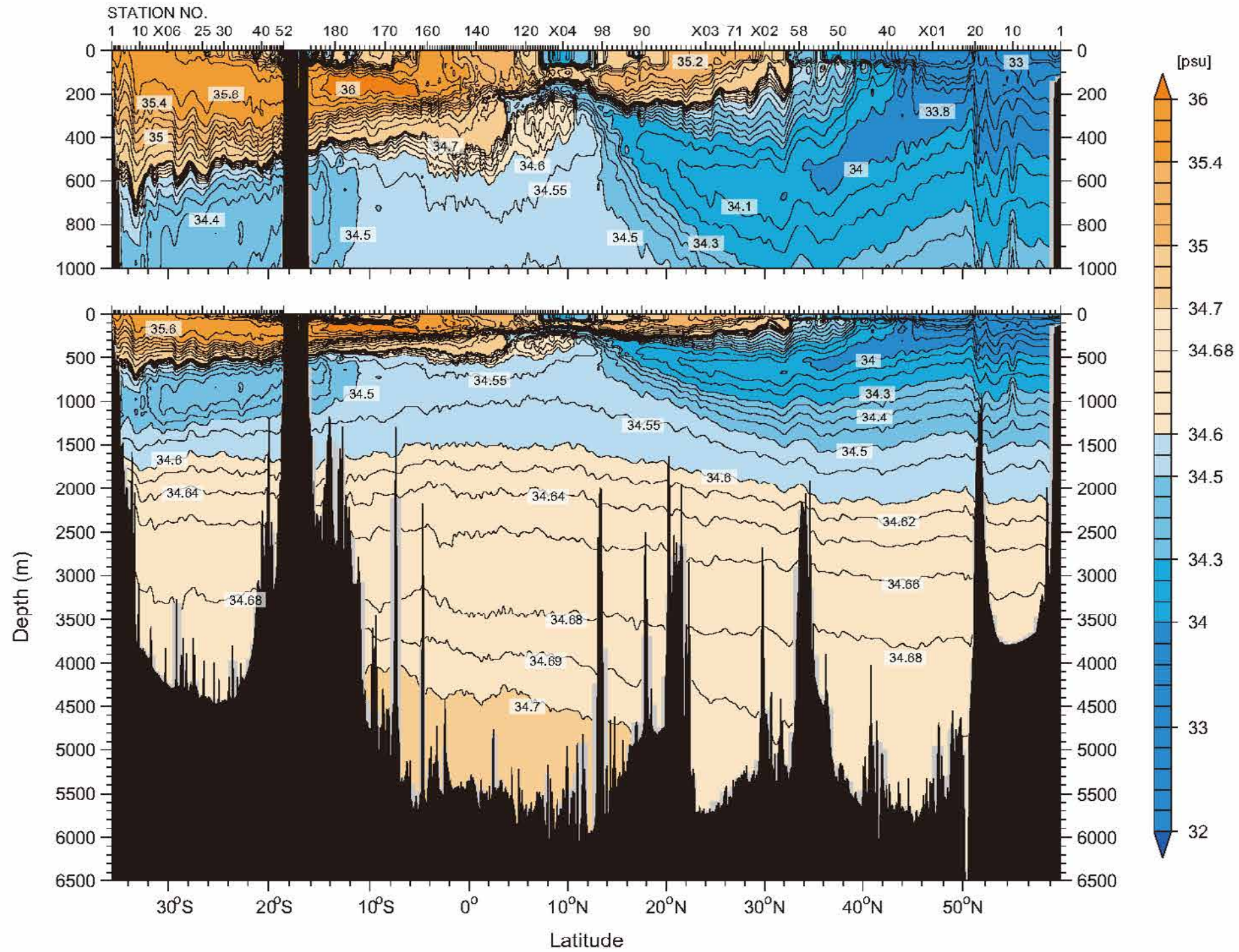
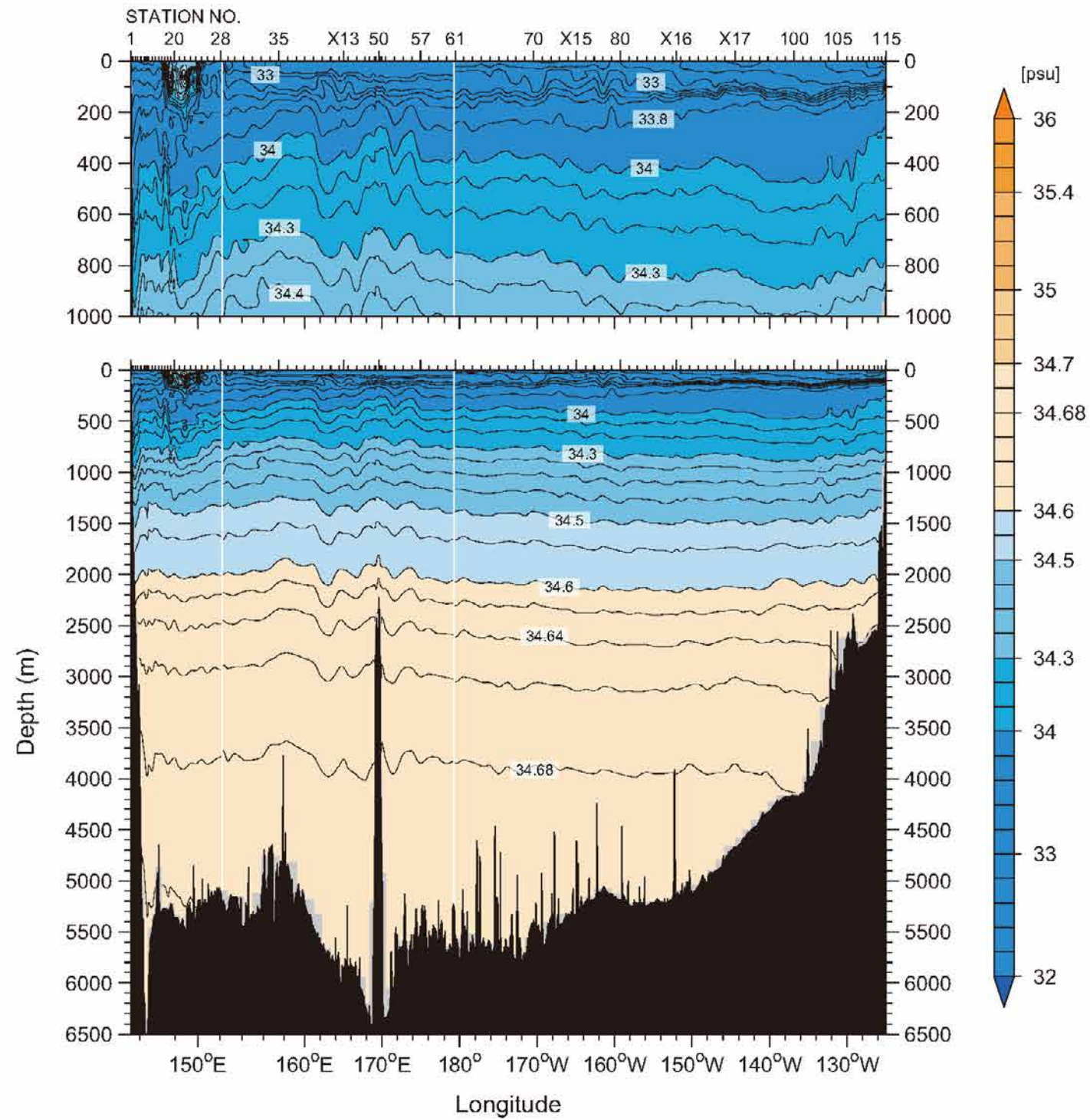

Figure 10
CTD salinity (psu) with SSW batch correction
(a) WHP-P01



(b) WHP-P14

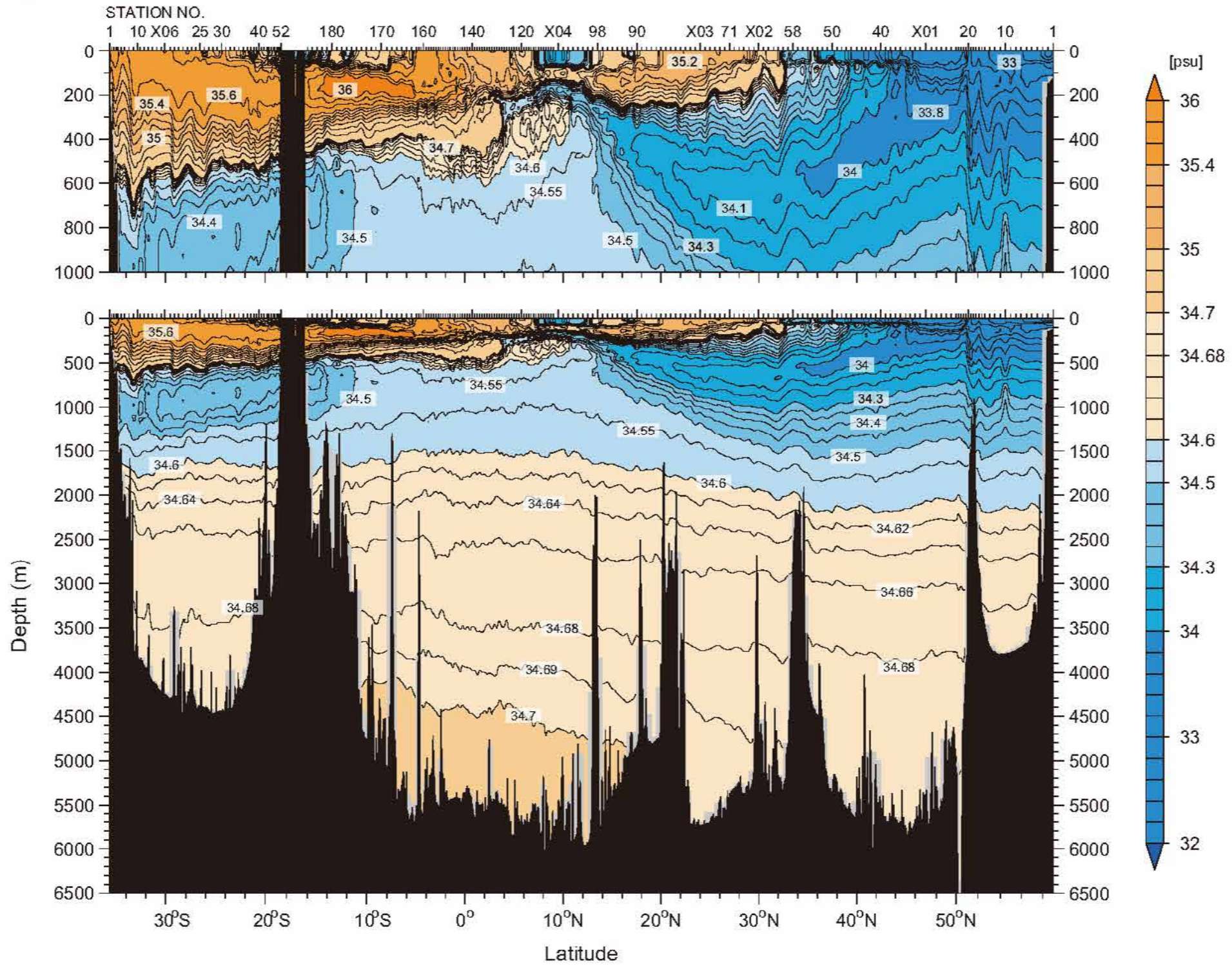
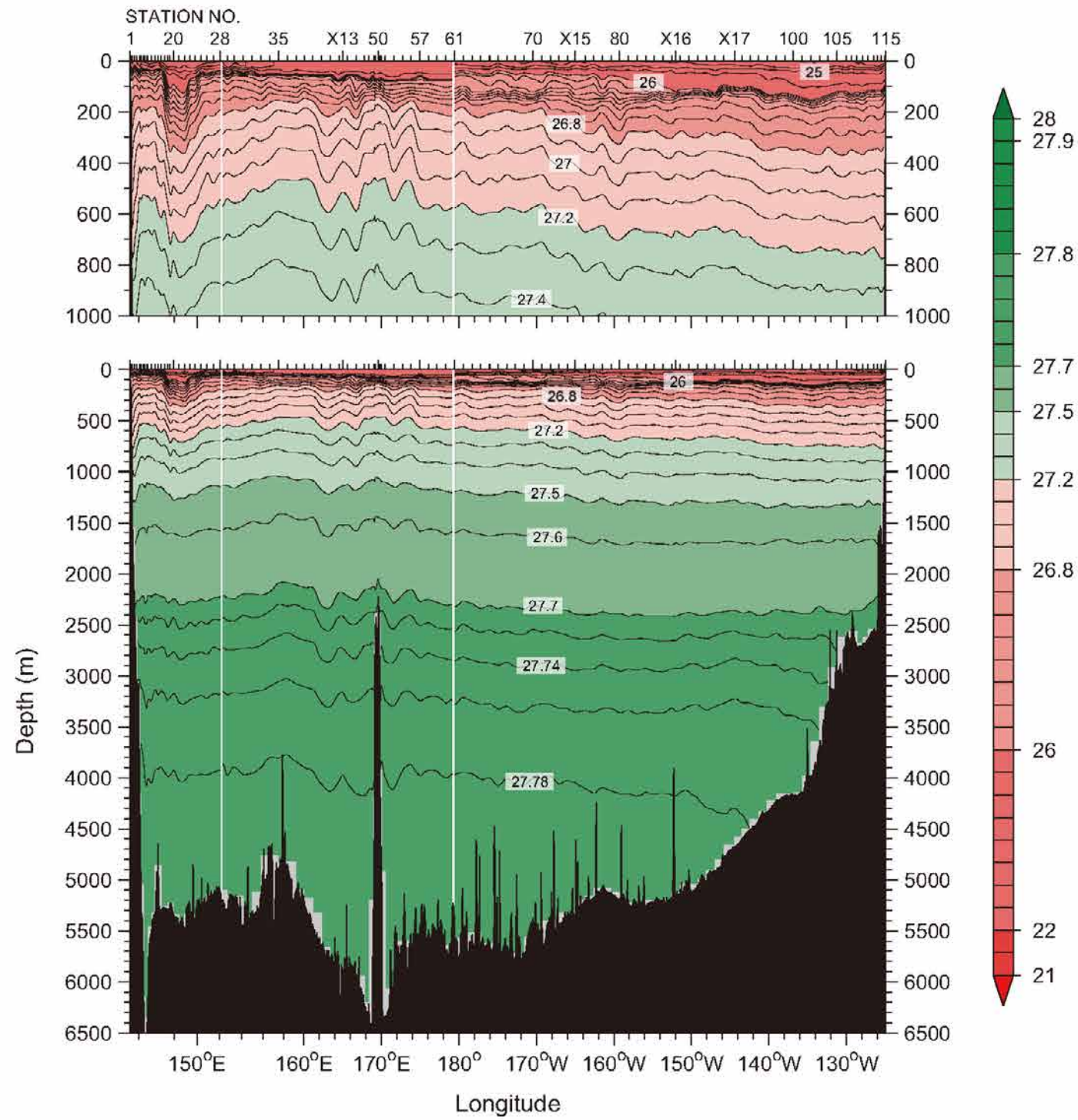

Figure 11
Density (σ_0) (kg/m^3)
(a) WHP-P01



(b) WHP-P14

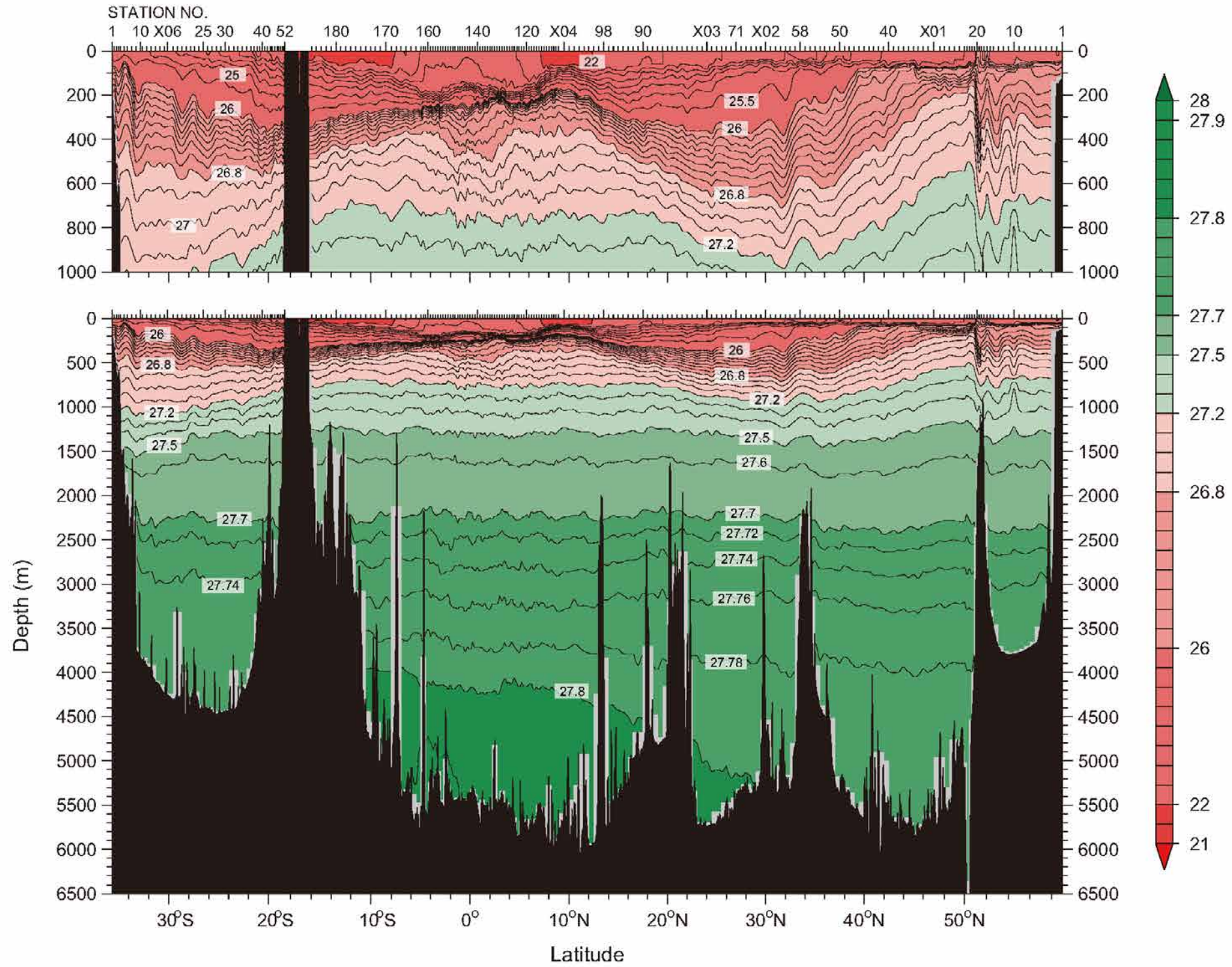
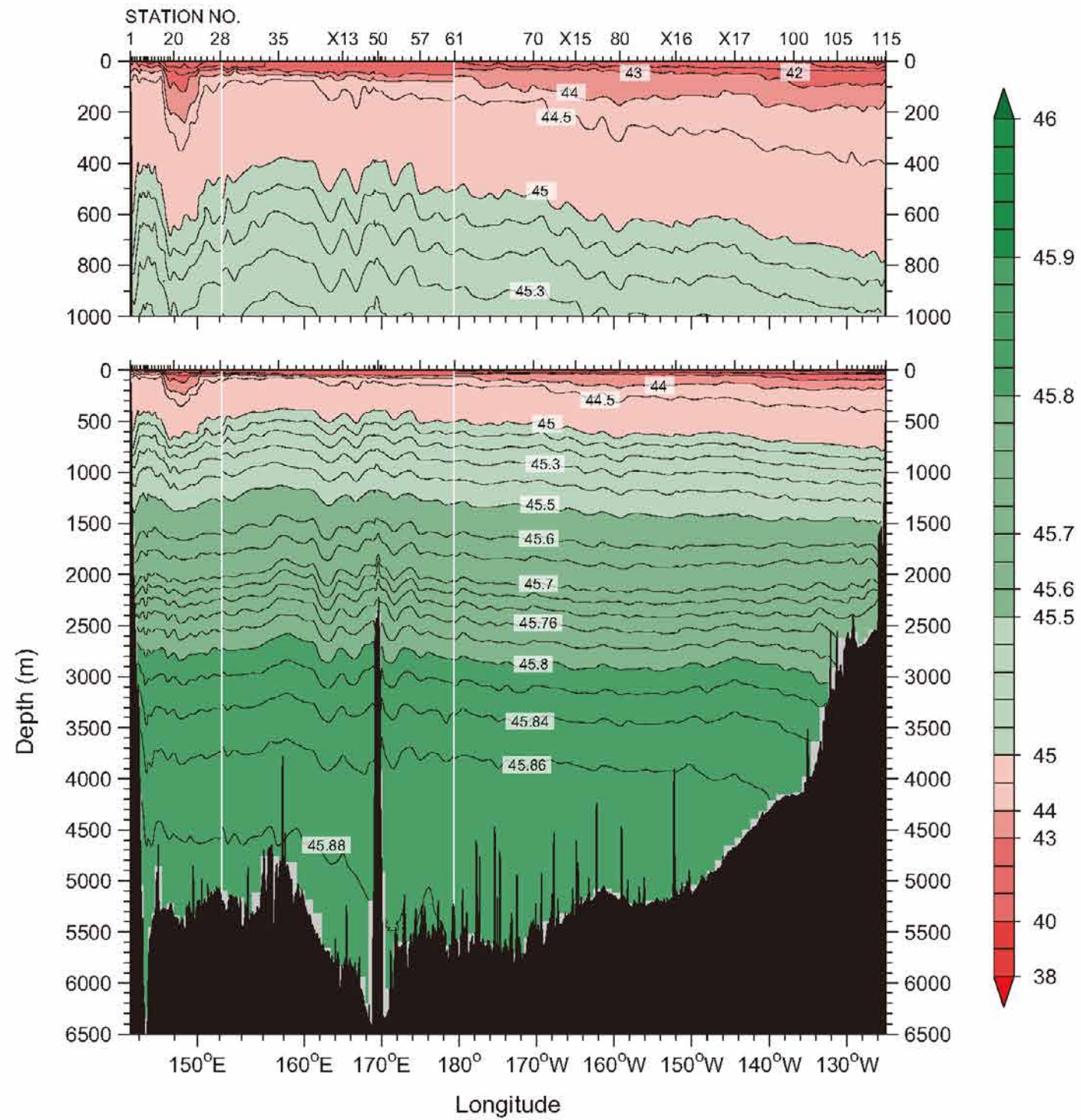

Figure 12
Density (σ_t) (kg/m^3)
(a) WHP-P01



(b) WHP-P14

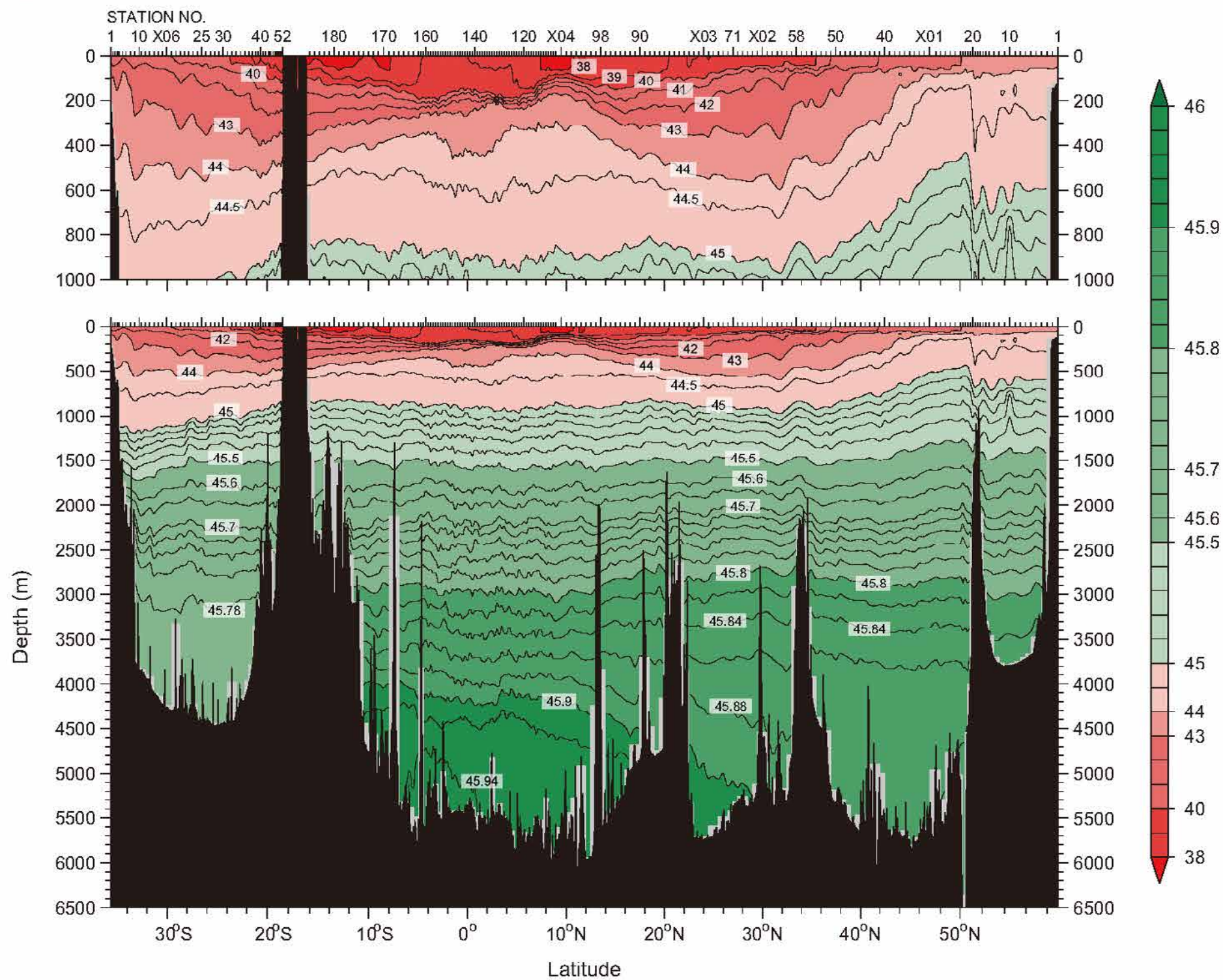
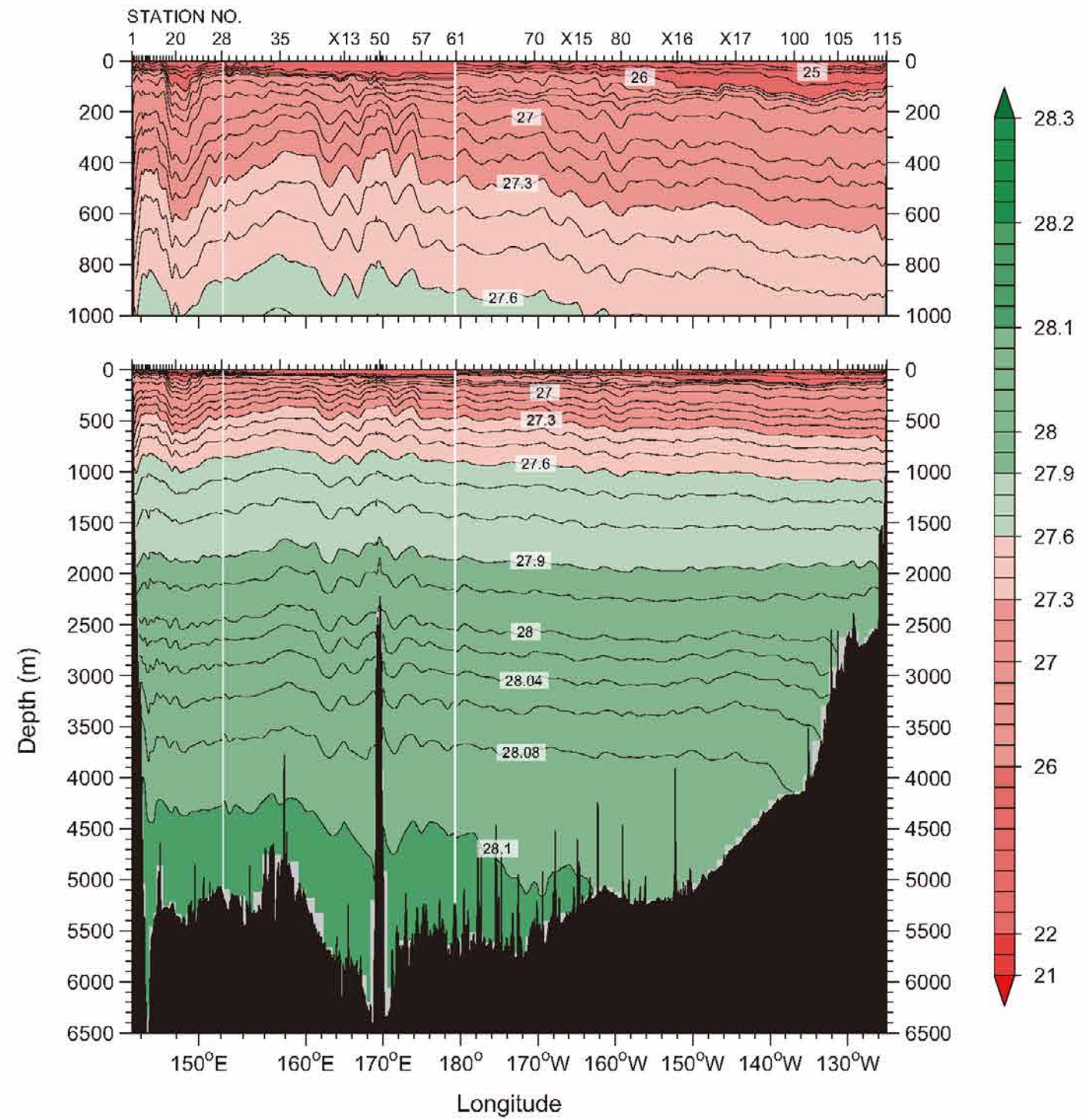

Figure 13
Density (γ^n) (kg/m^3)
(a) WHP-P01



(b) WHP-P14

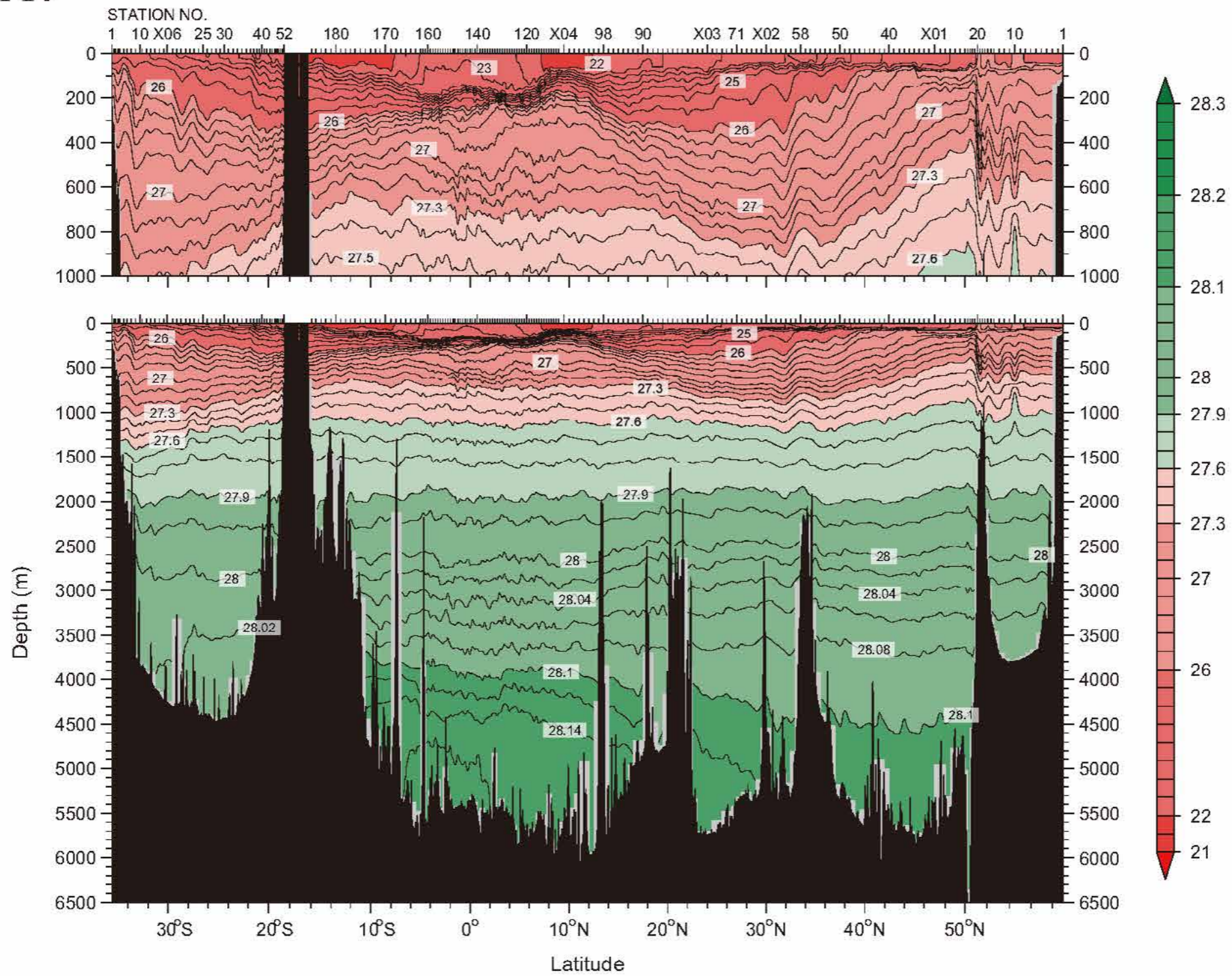
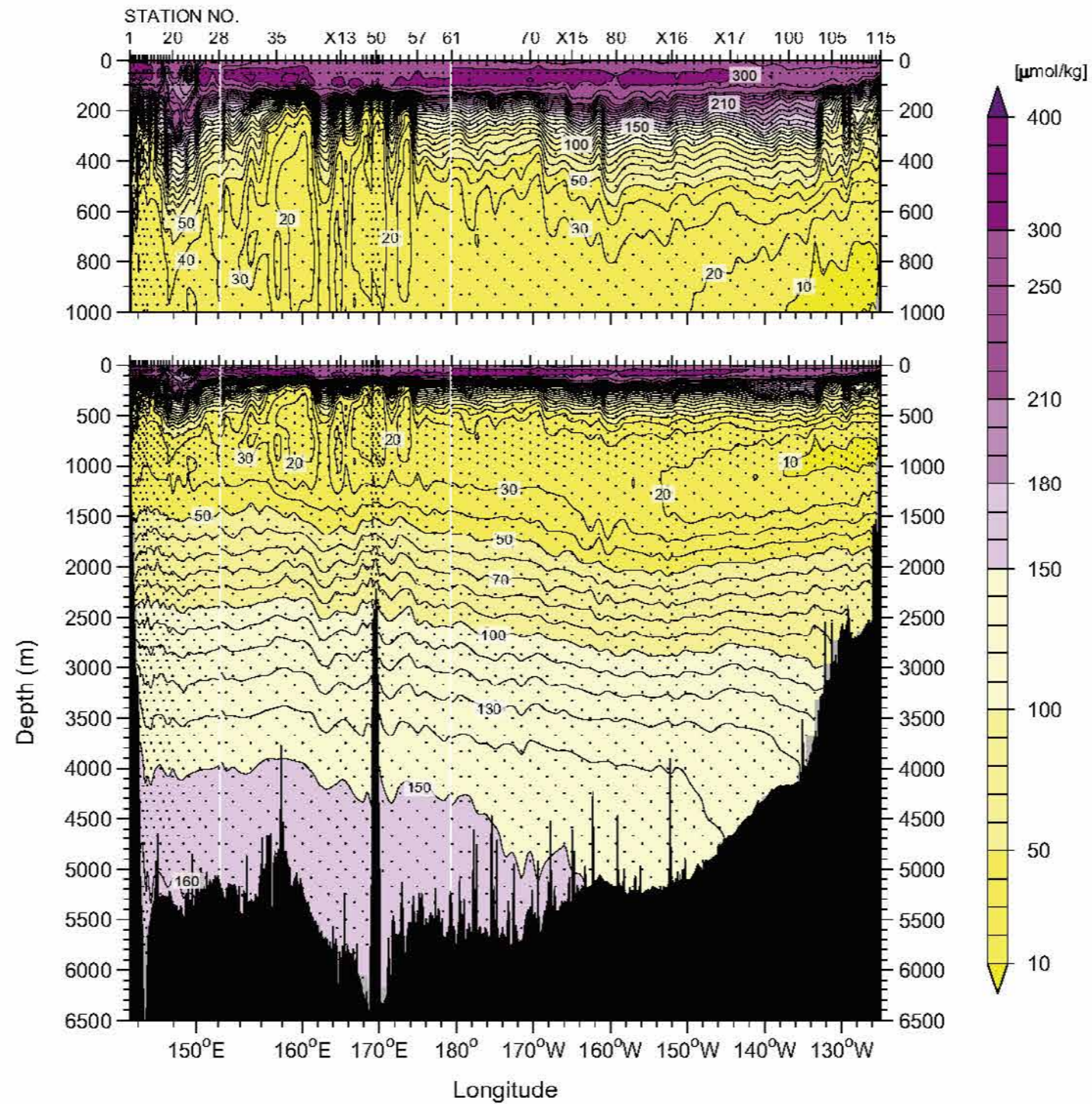

Figure 14
Bottle sampled dissolved oxygen ($\mu\text{mol/kg}$)
(a) WHP-P01



(b) WHP-P14

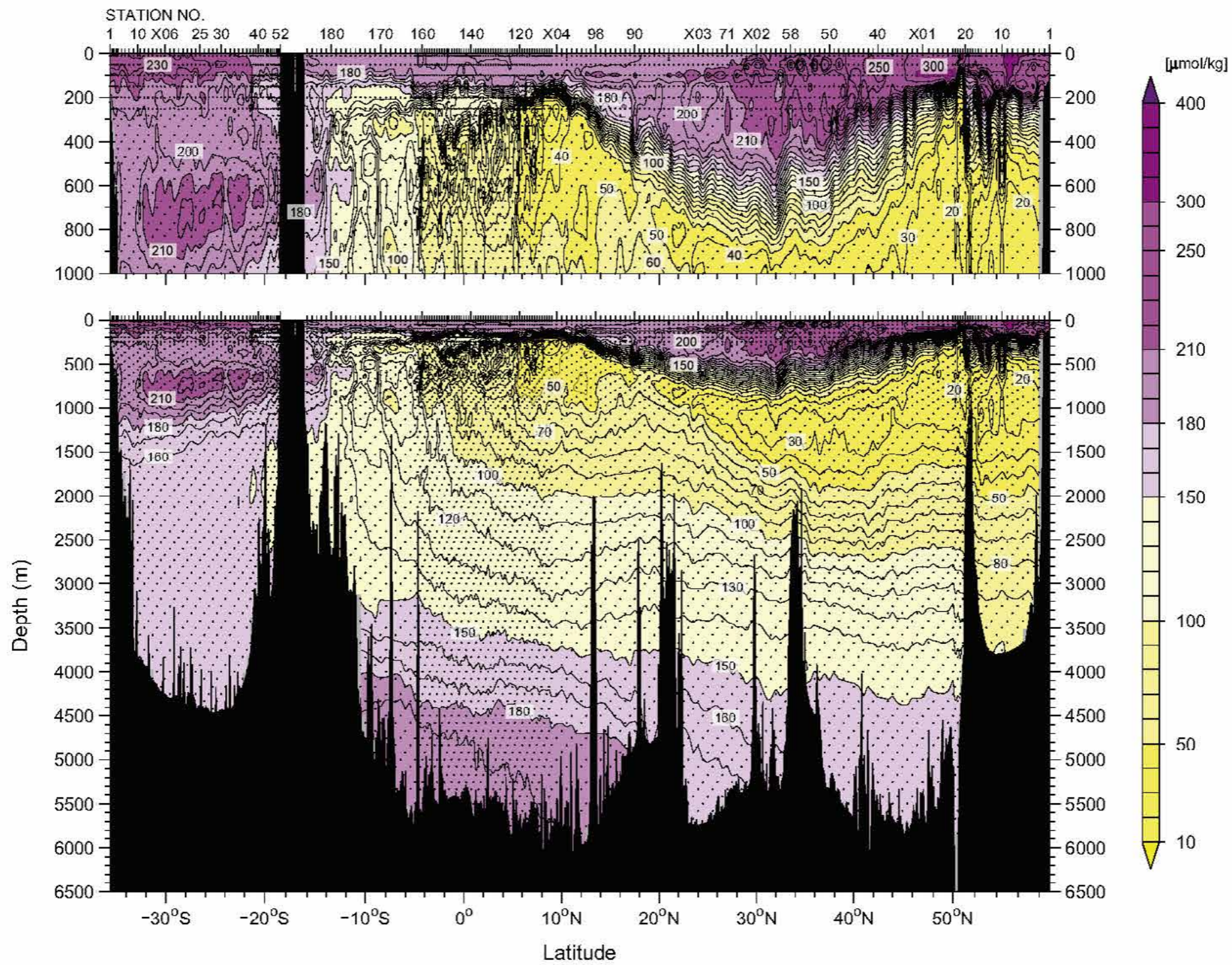
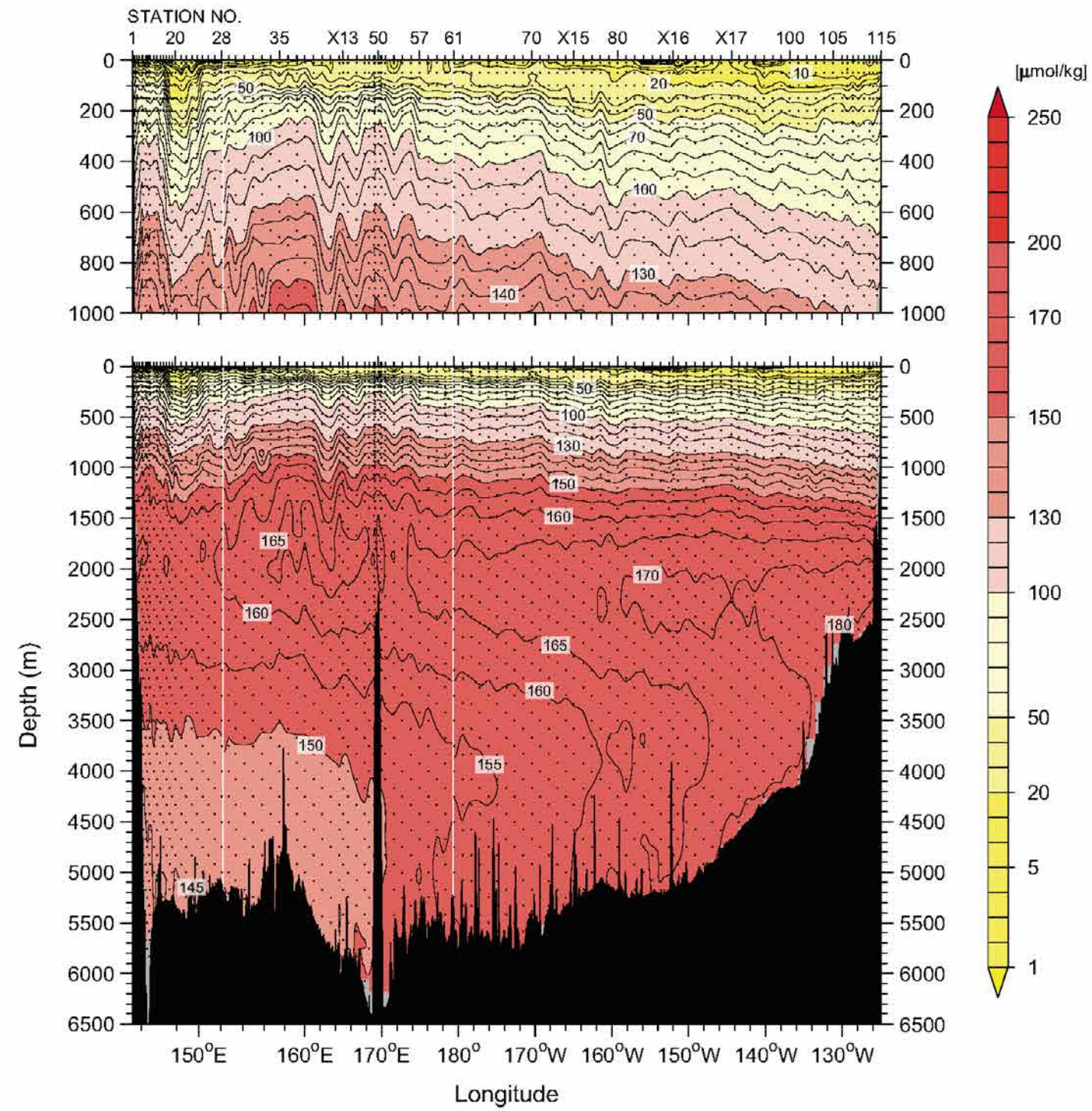

Figure 15
Silicate ($\mu\text{mol/kg}$)
(a) WHP-P01



(b) WHP-P14

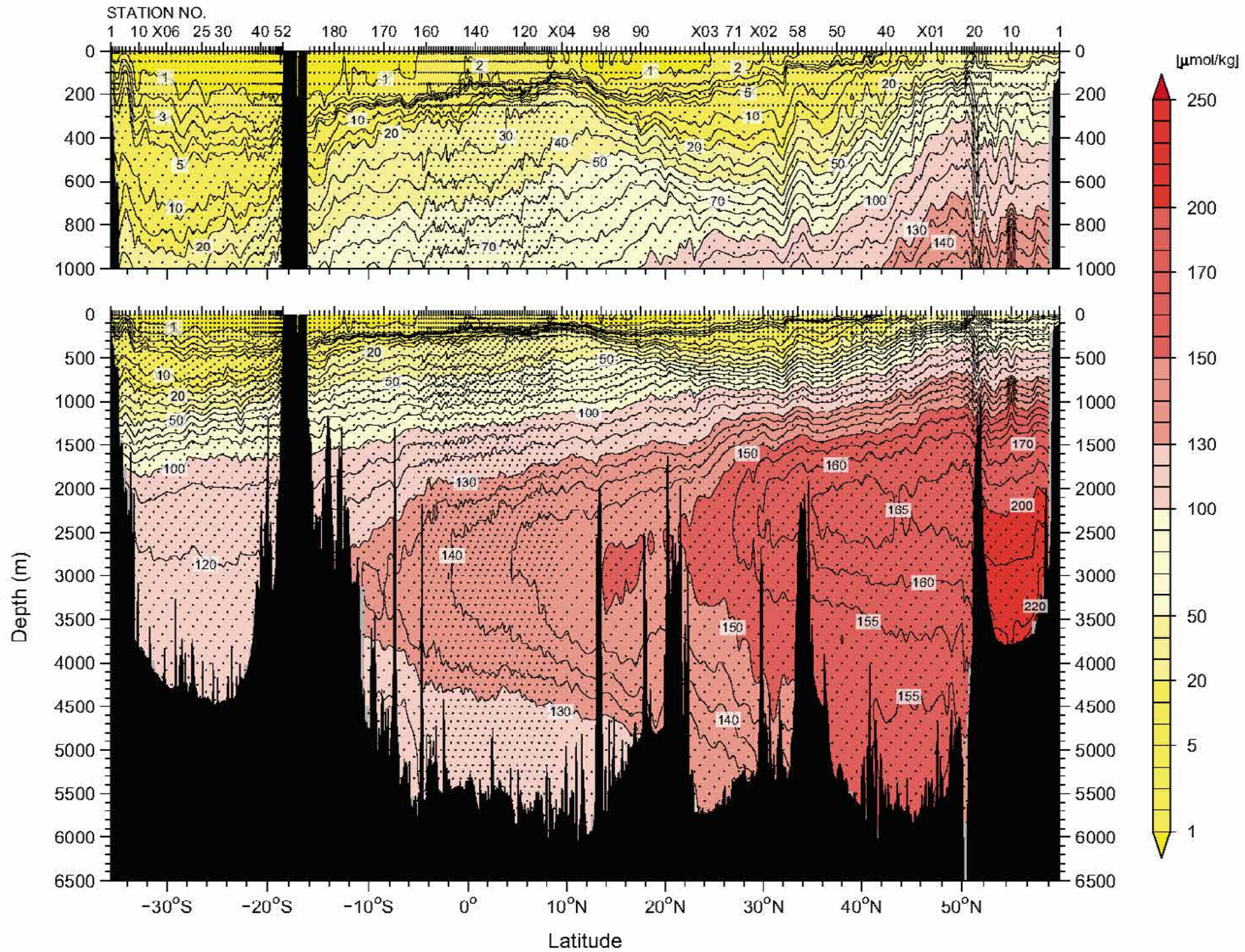
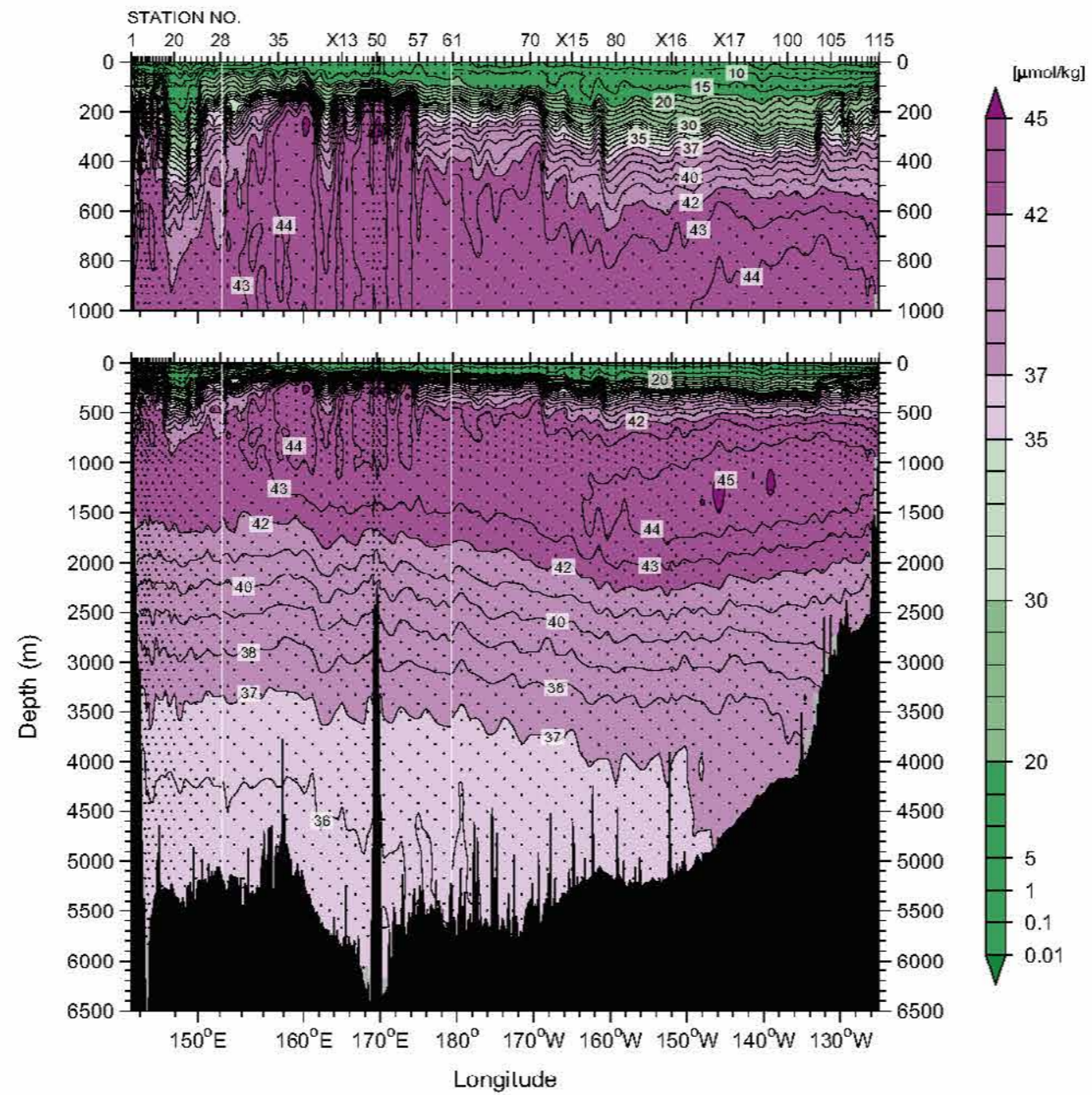

Figure 16
Nitrate ($\mu\text{mol/kg}$)
(a) WHP-P01



(b) WHP-P14

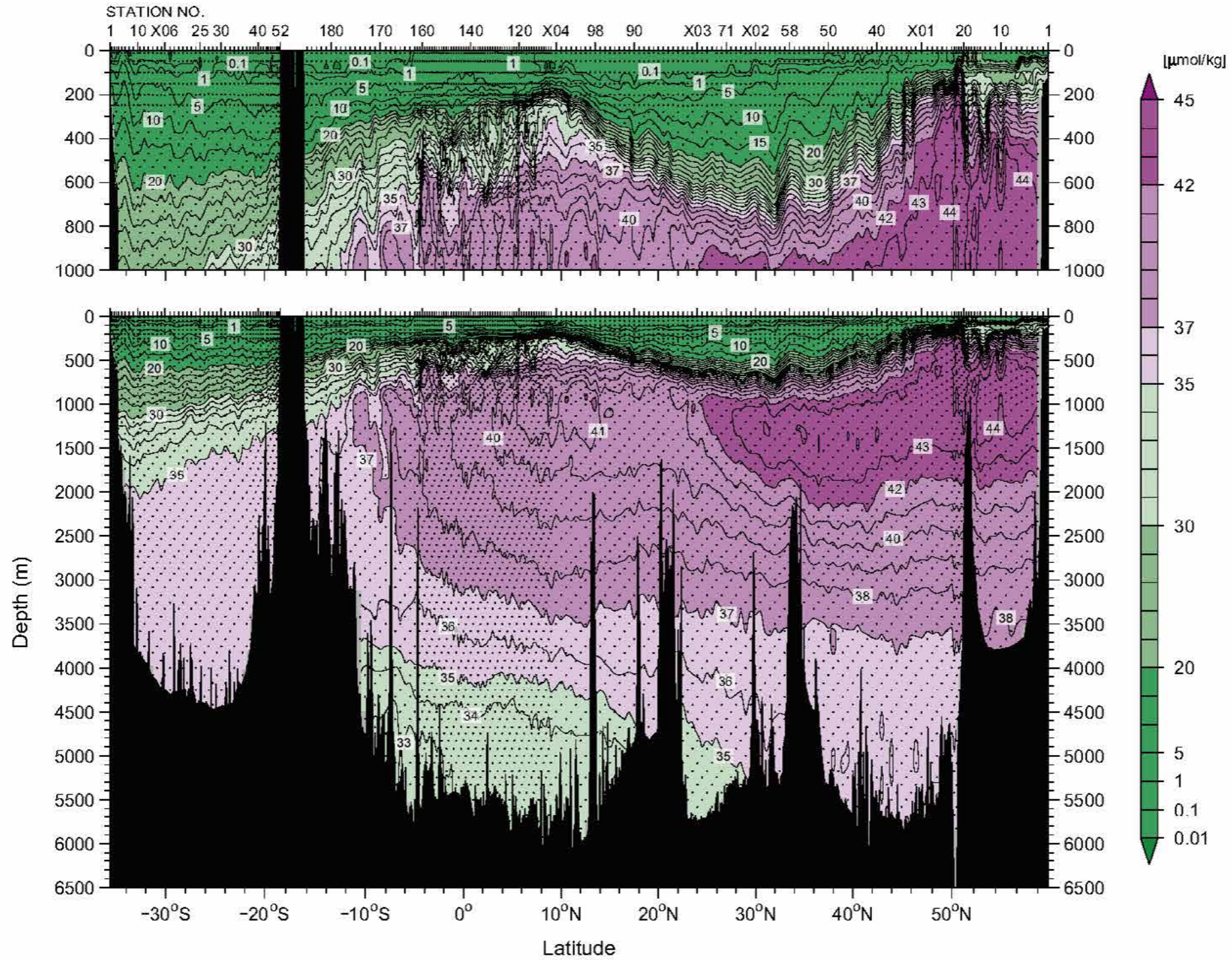
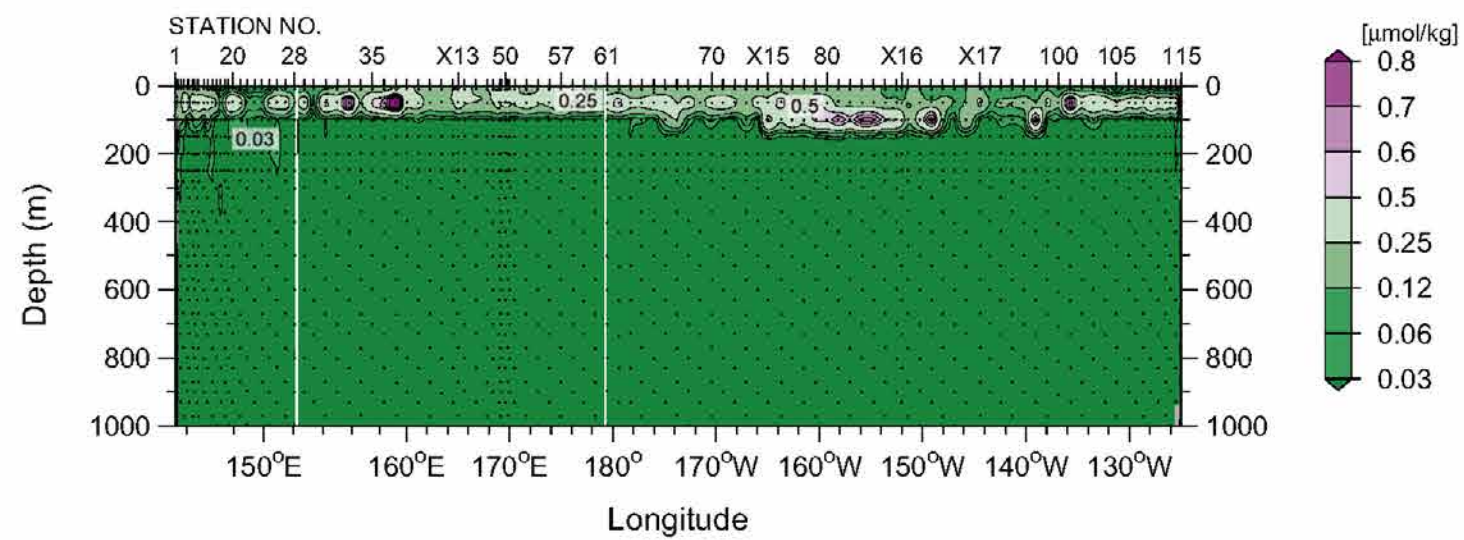

Figure 17
Nitrite ($\mu\text{mol/kg}$)
(a) WHP-P01



(b) WHP-P14

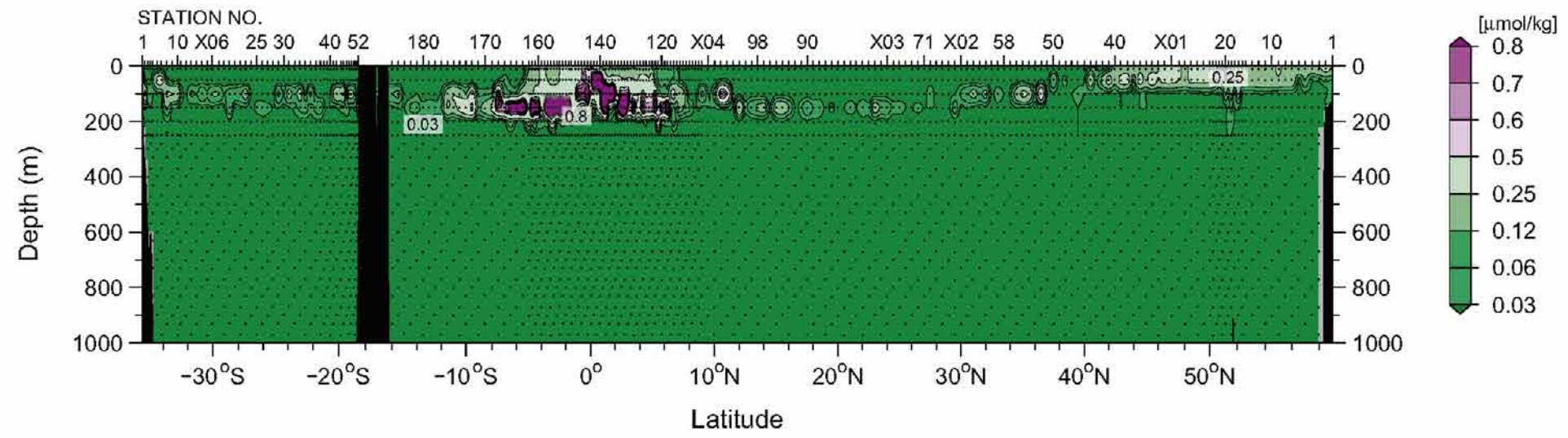
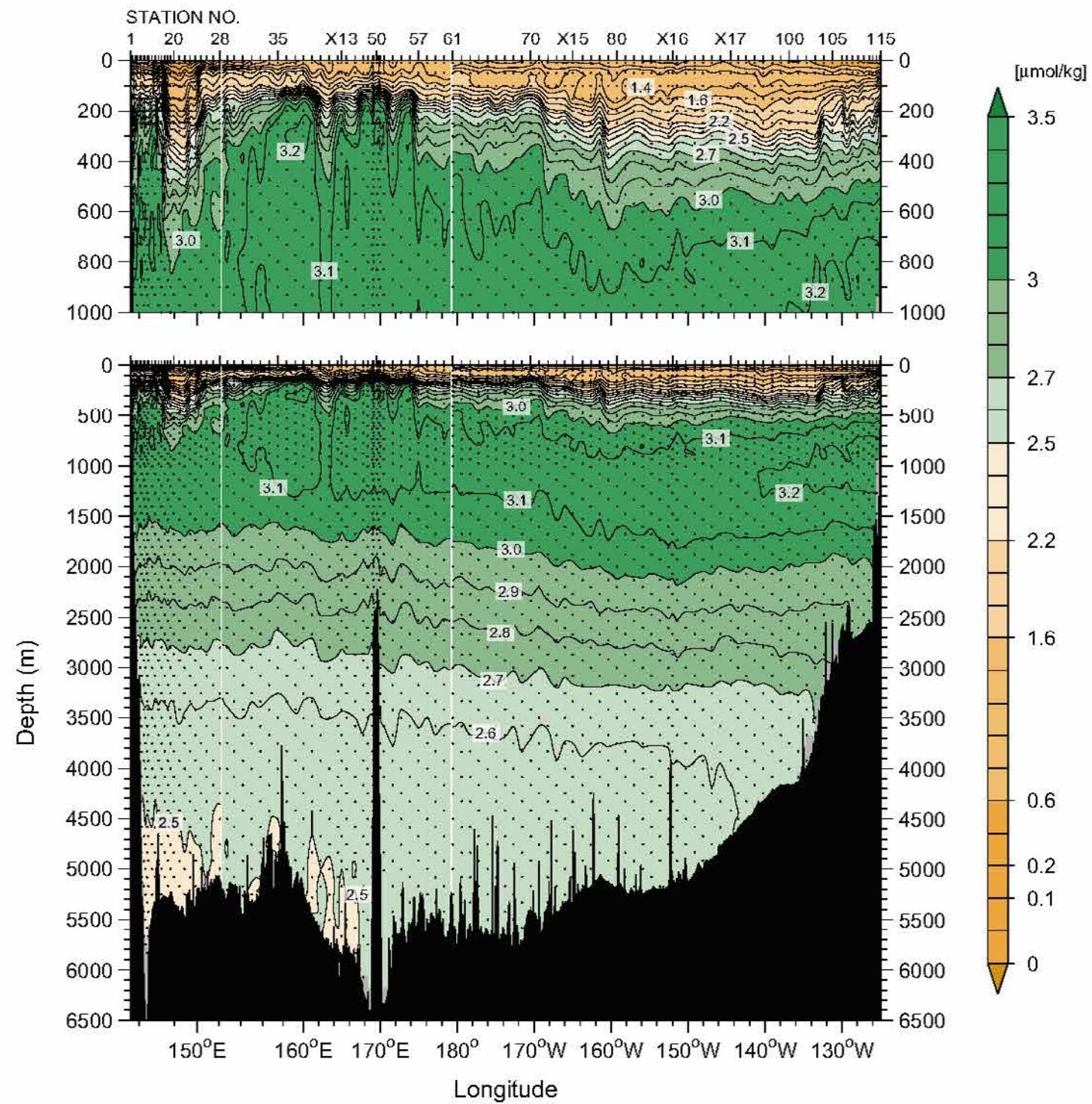

Figure 18
Phosphate ($\mu\text{mol/kg}$)
(a) WHP-P01



(b) WHP-P14

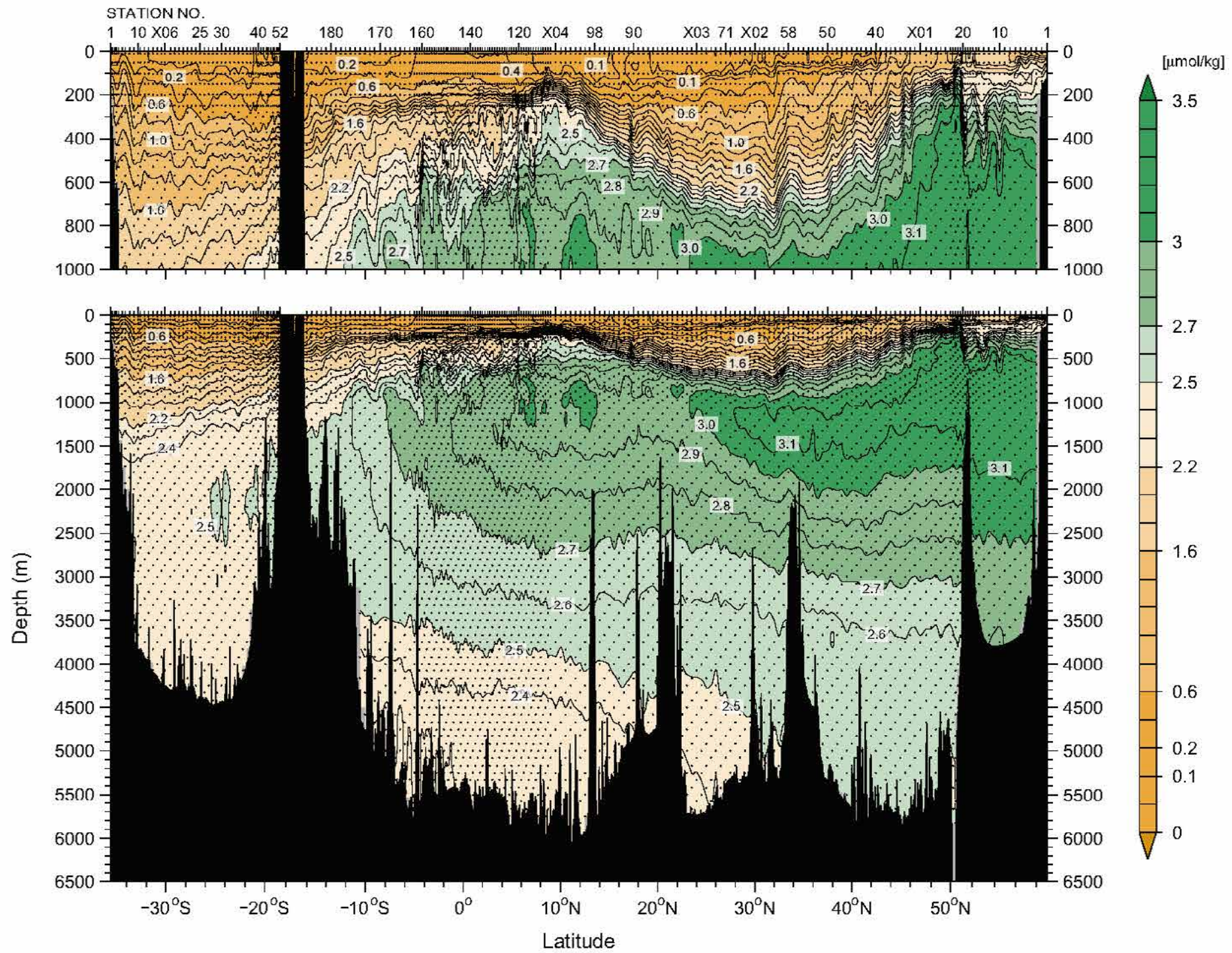
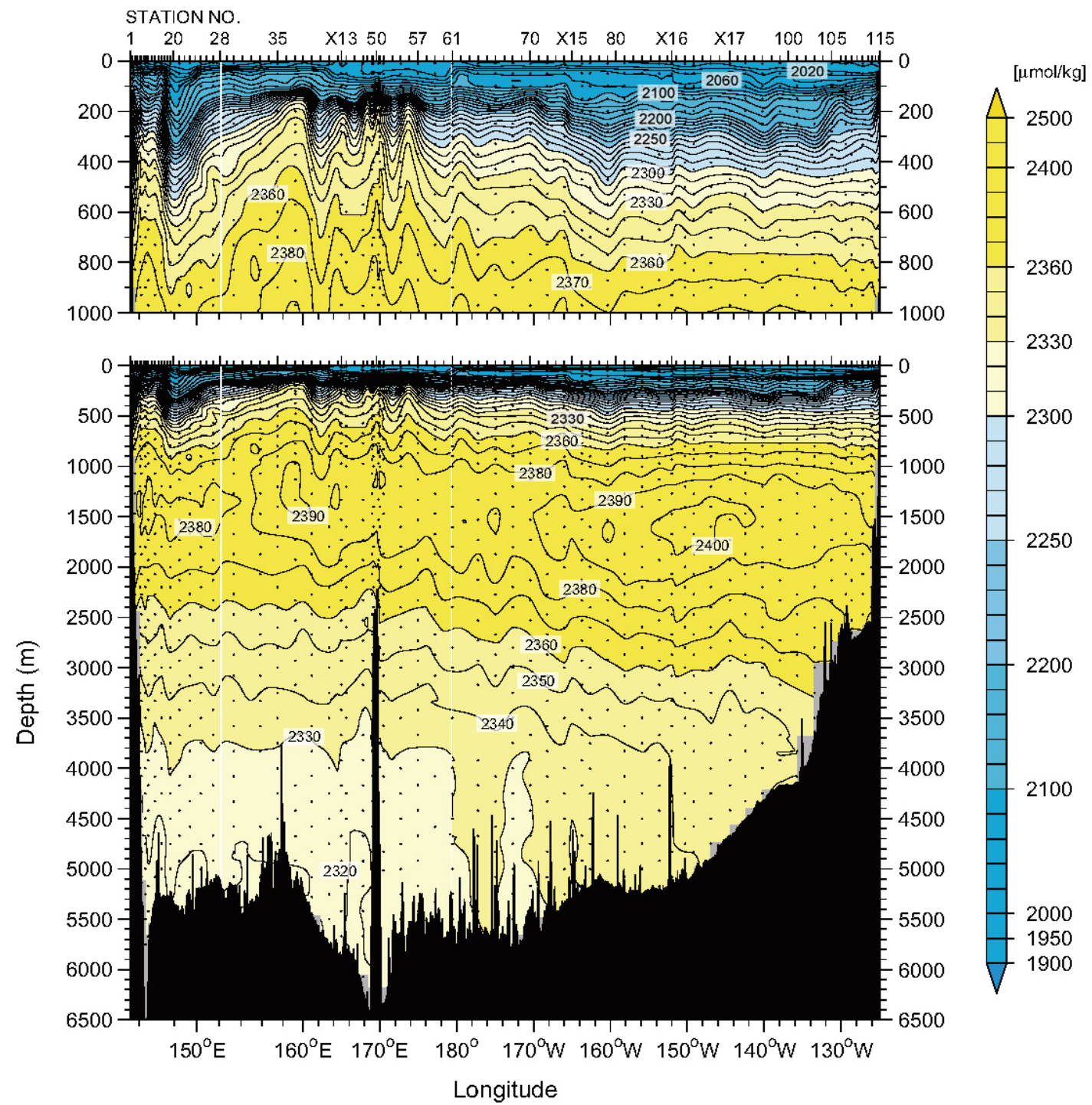

Figure 19
Dissolved inorganic carbon ($\mu\text{mol/kg}$)
(a) WHP-P01



(b) WHP-P14

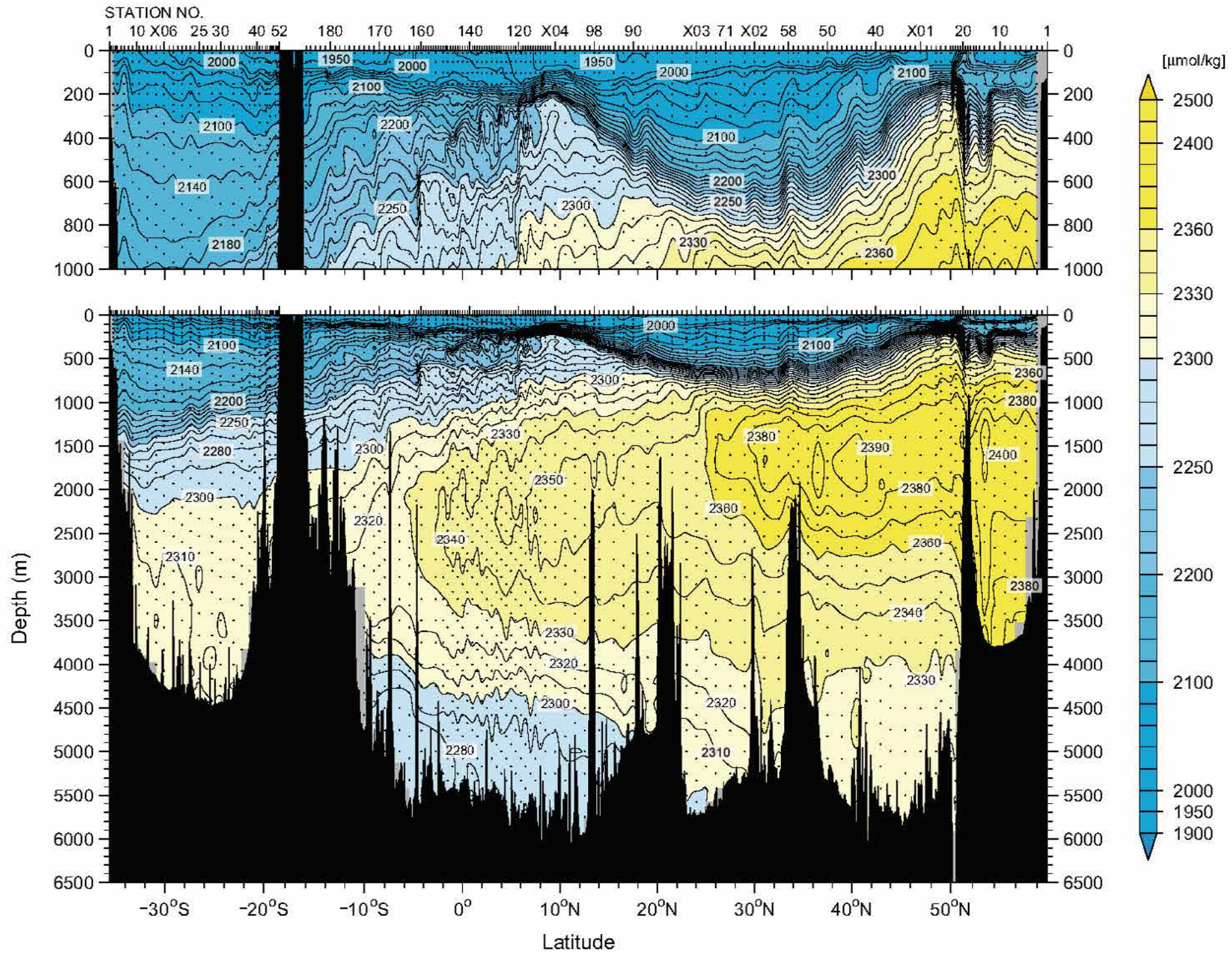
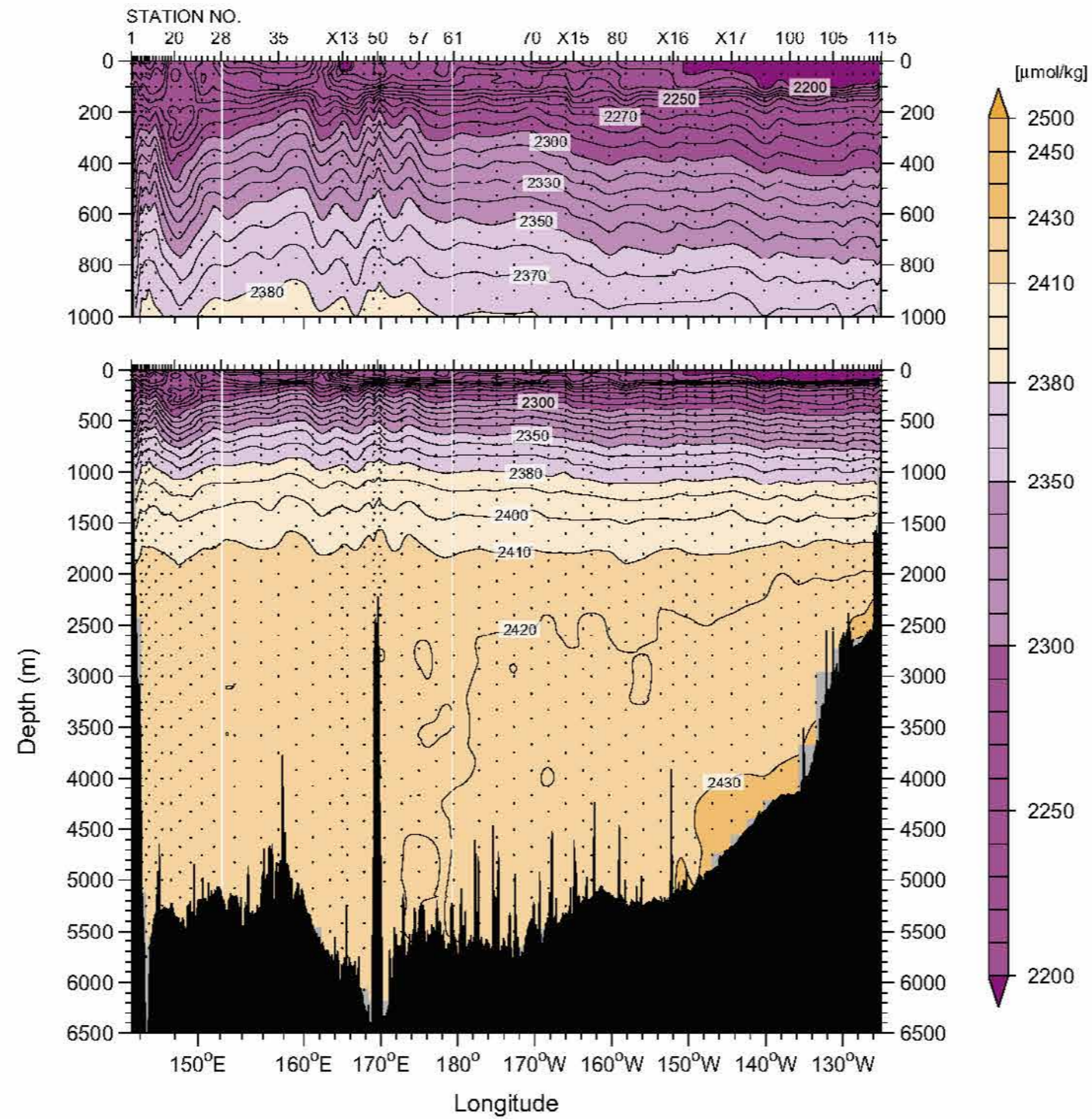

Figure 20
Total alkalinity ($\mu\text{mol/kg}$)
(a) WHP-P01



(b) WHP-P14

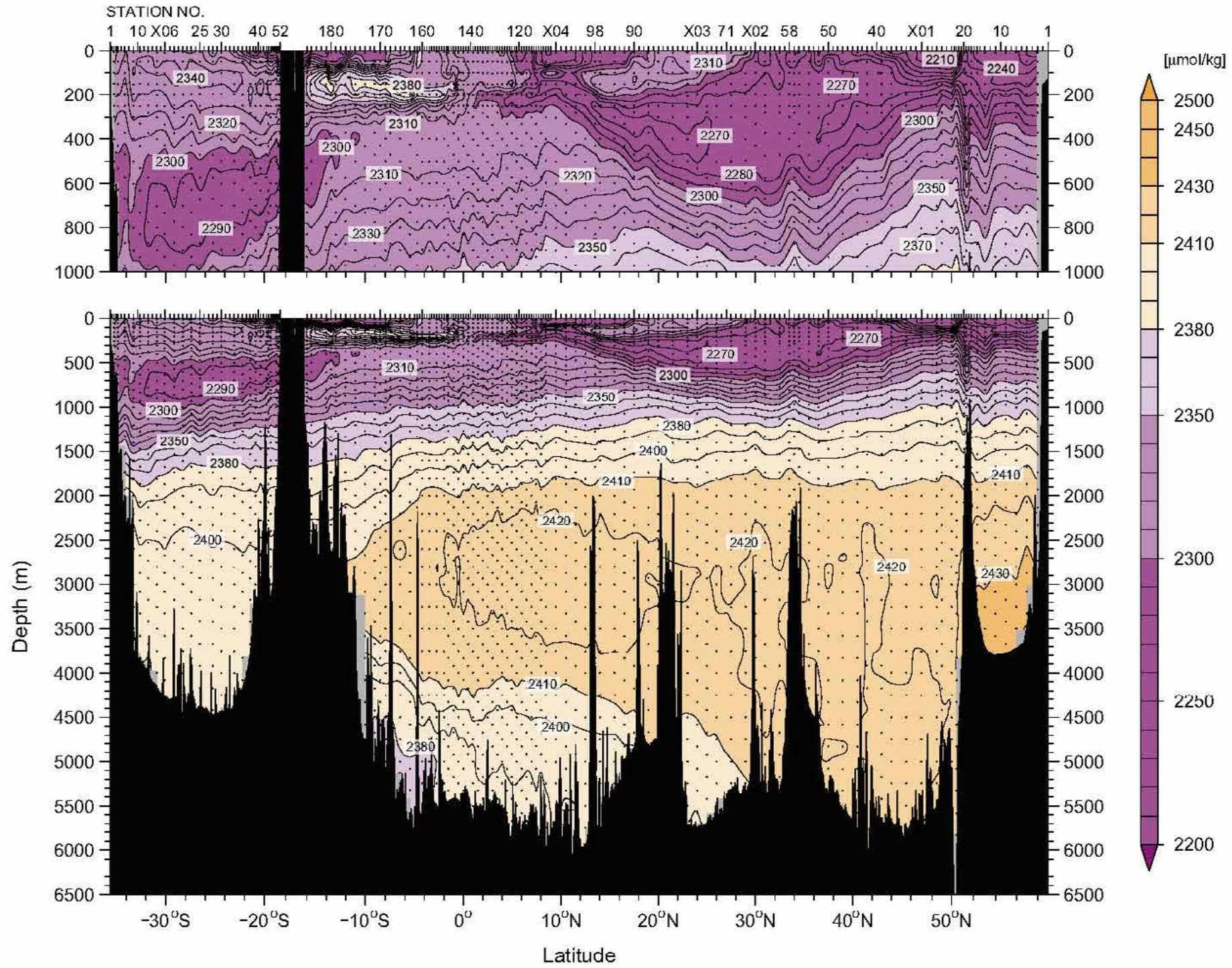
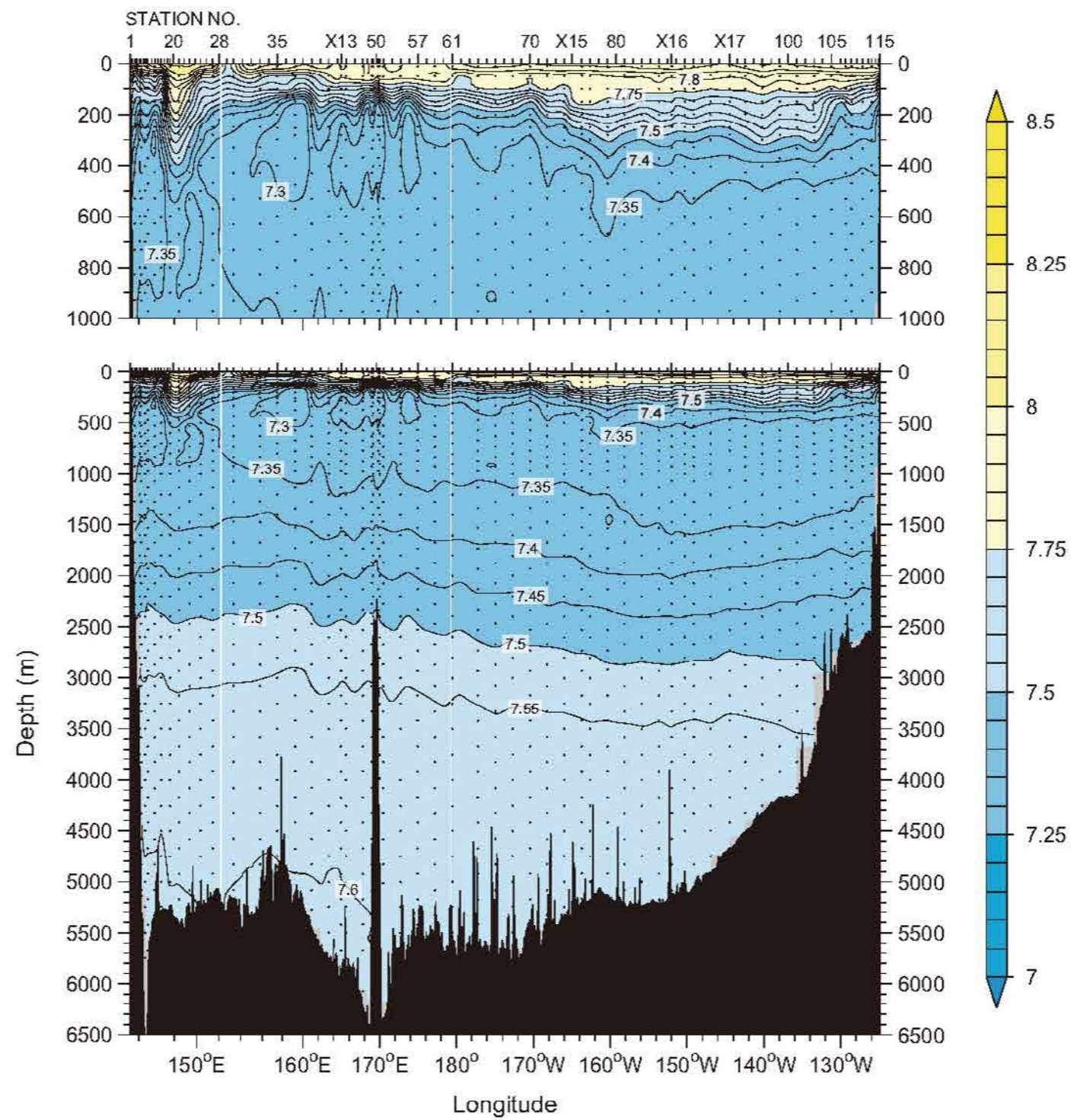

Figure 21
pH
(a) WHP-P01



(b) WHP-P14

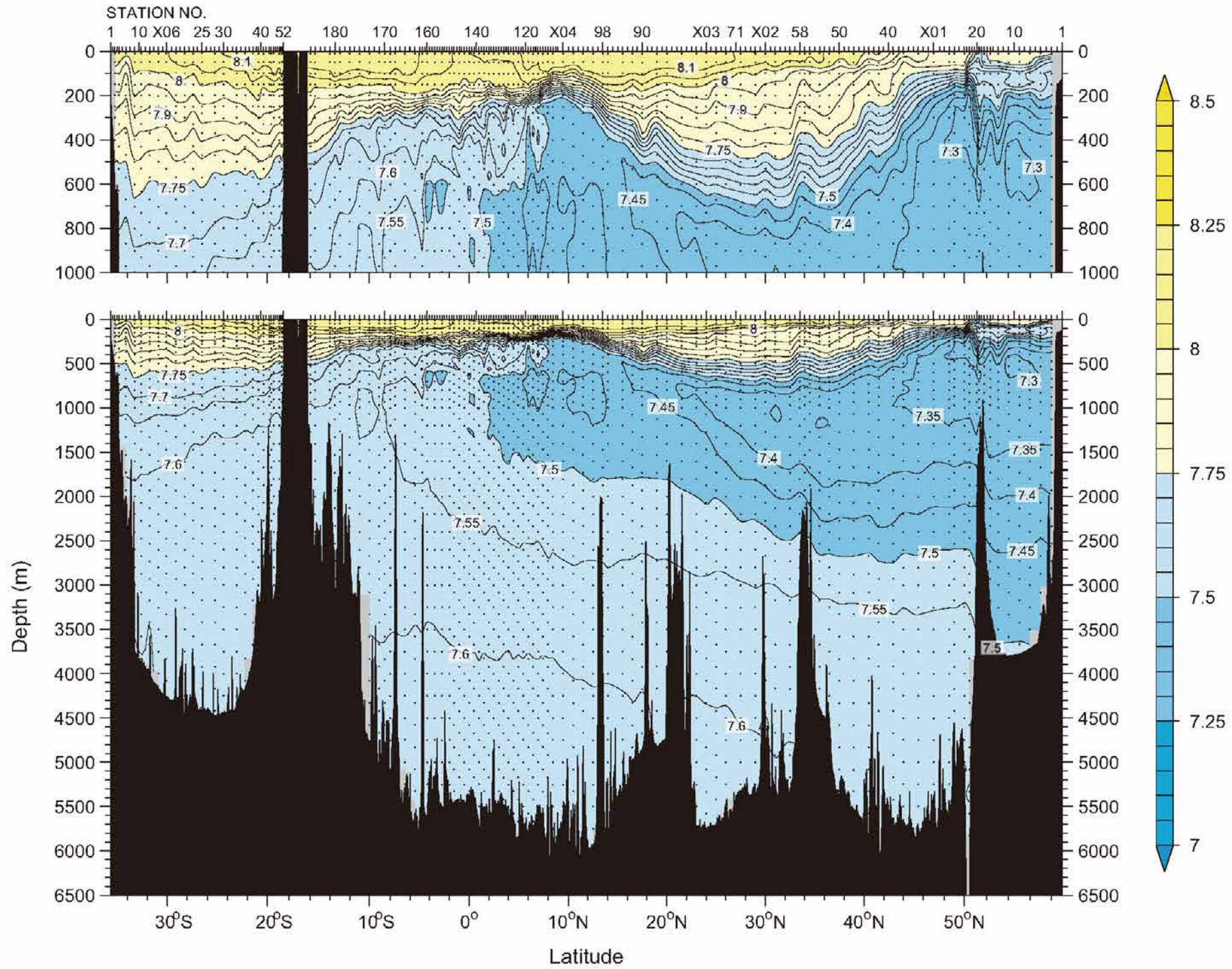
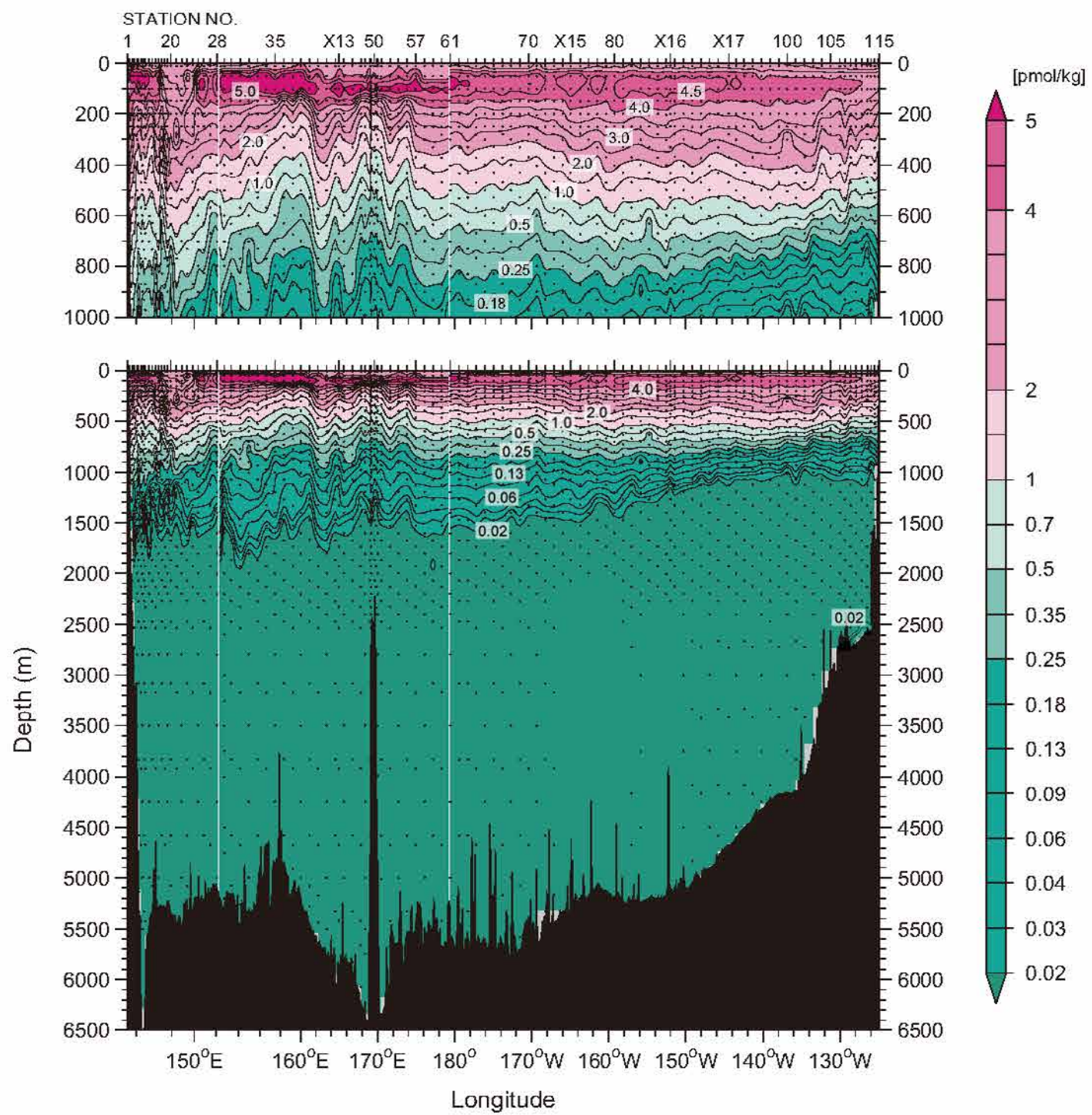

Figure 22
CFC-11 (pmol/kg)
(a) WHP-P01



(b) WHP-P14

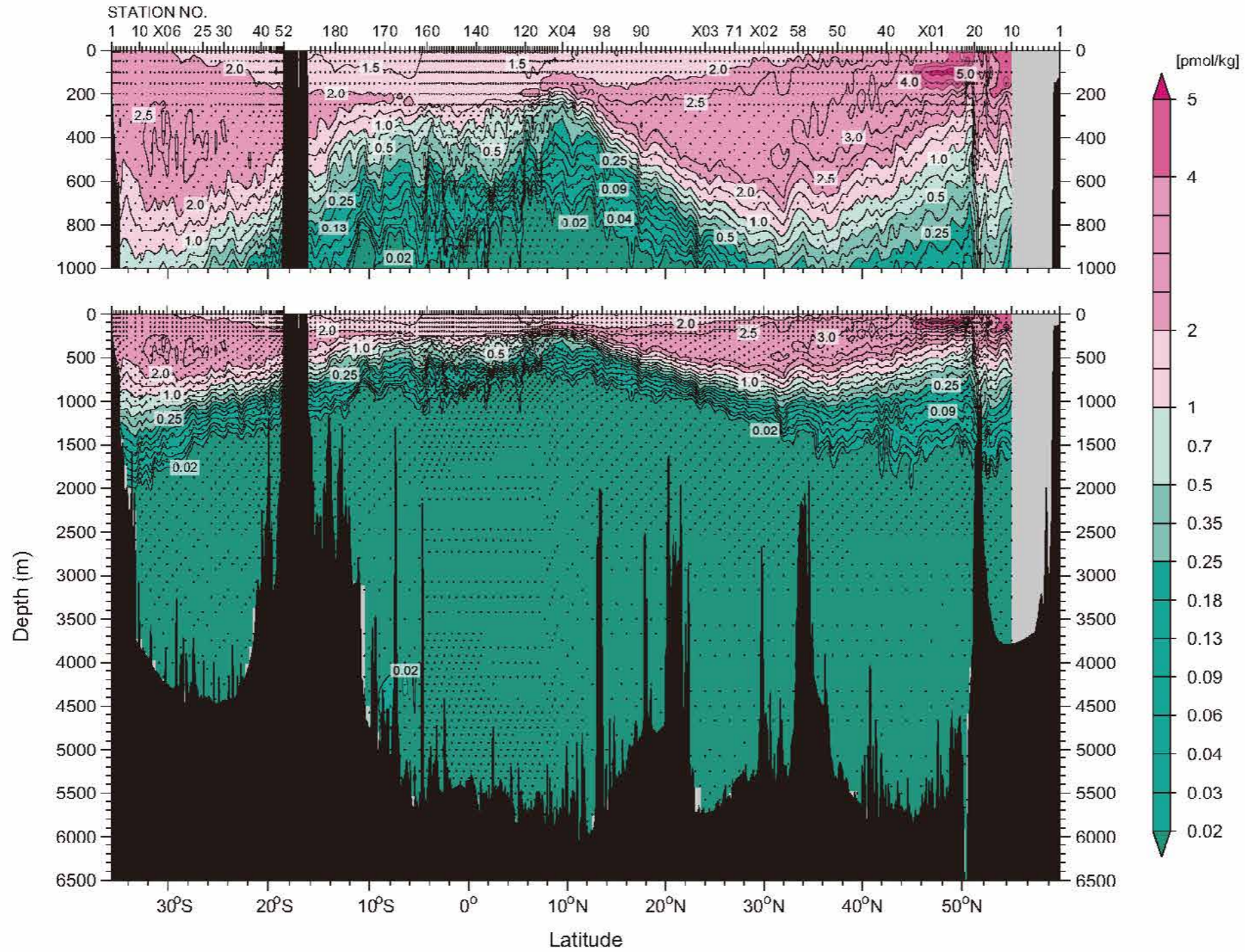
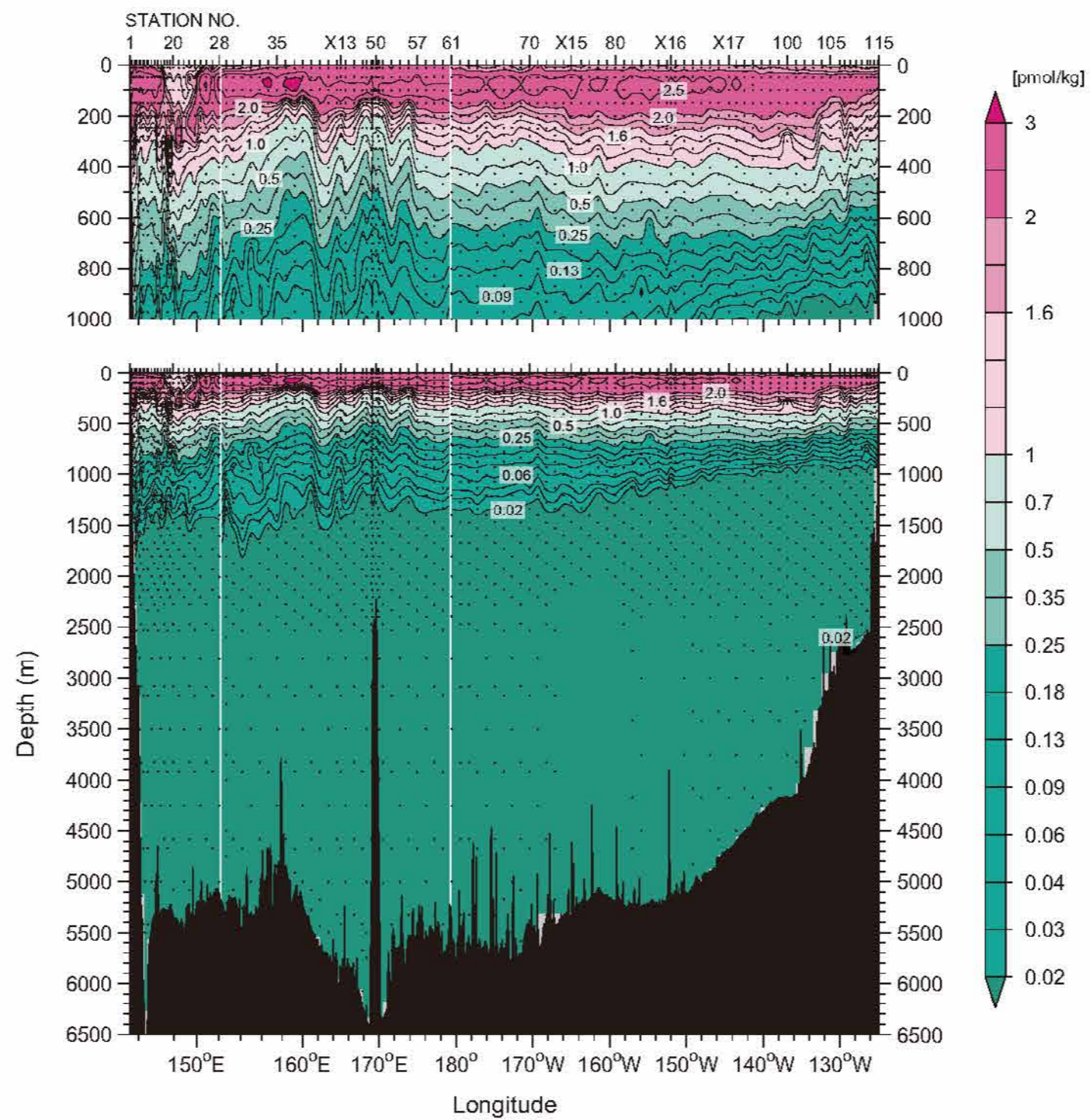

Figure 23
CFC-12 (pmol/kg)
(a) WHP-P01



(b) WHP-P14

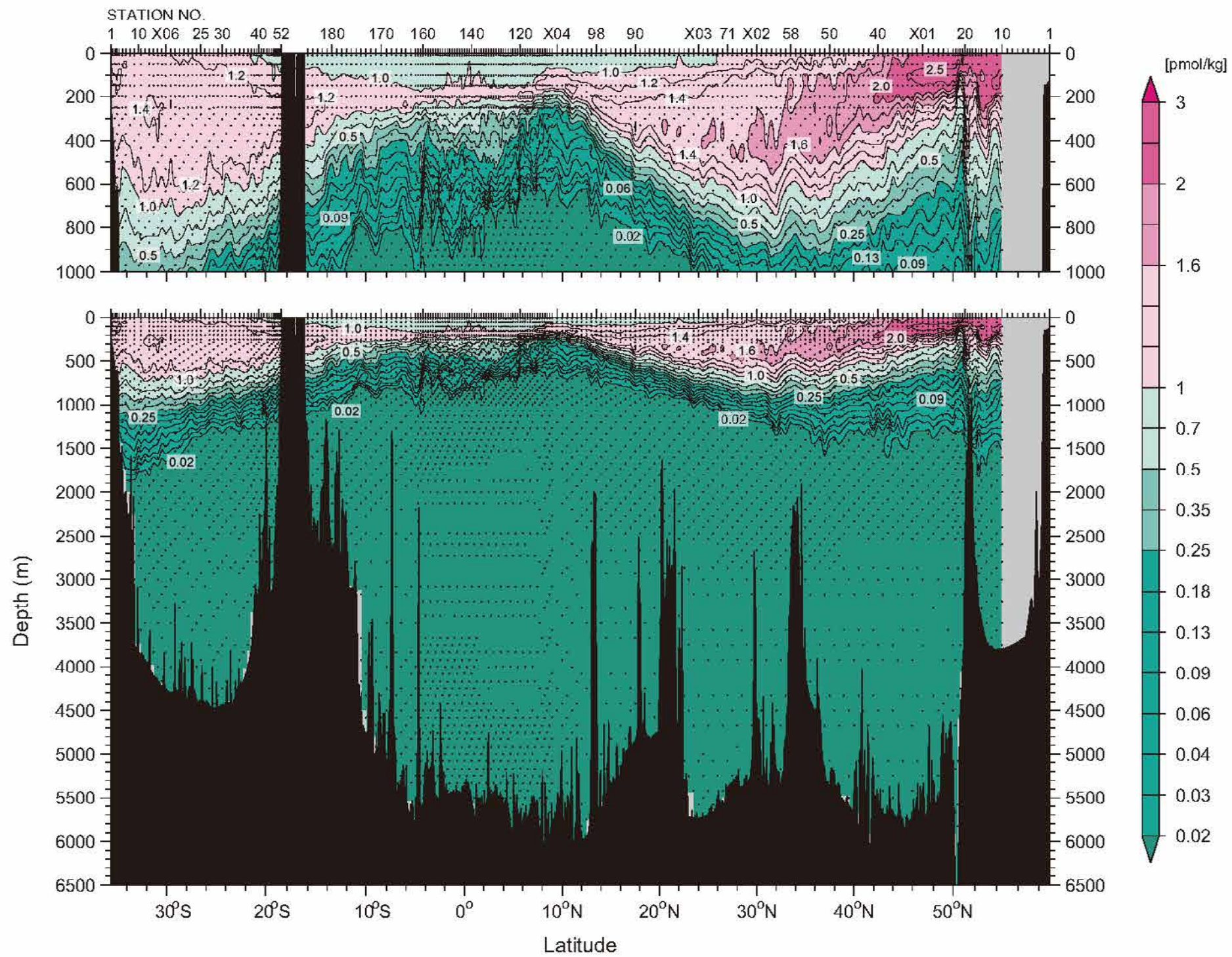
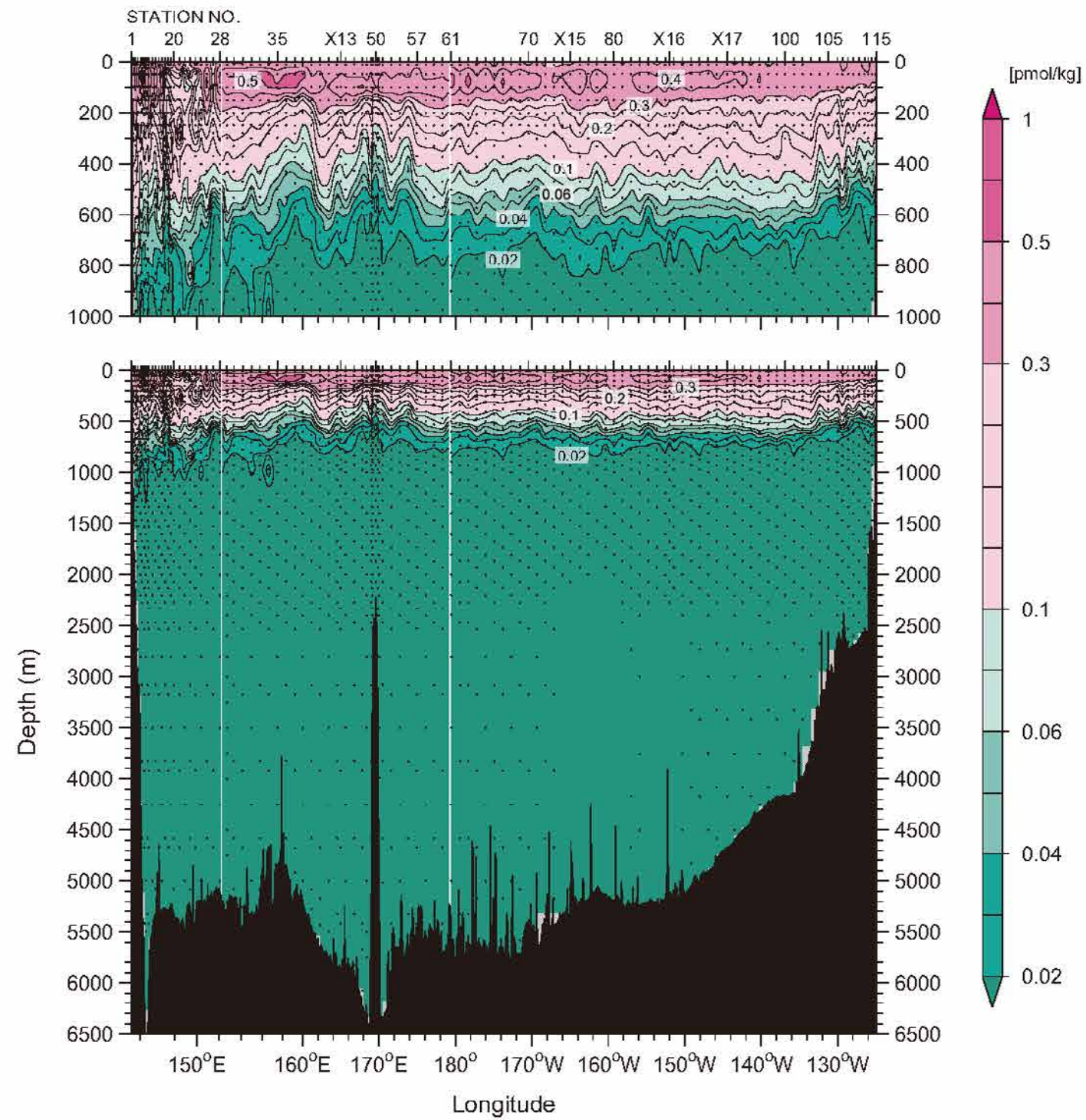

Figure 24
CFC-113 (pmol/kg)
(a) WHP-P01



(b) WHP-P14

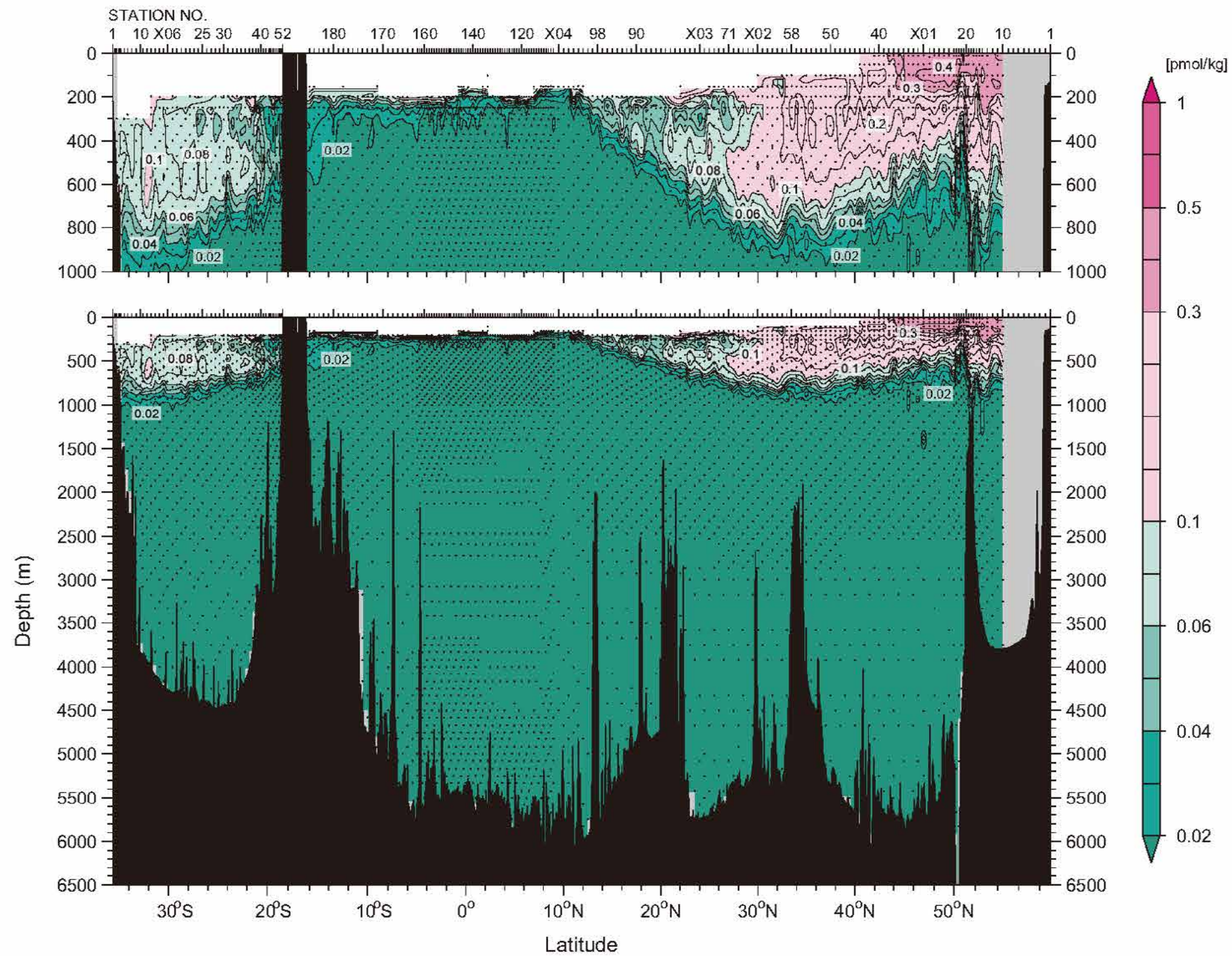
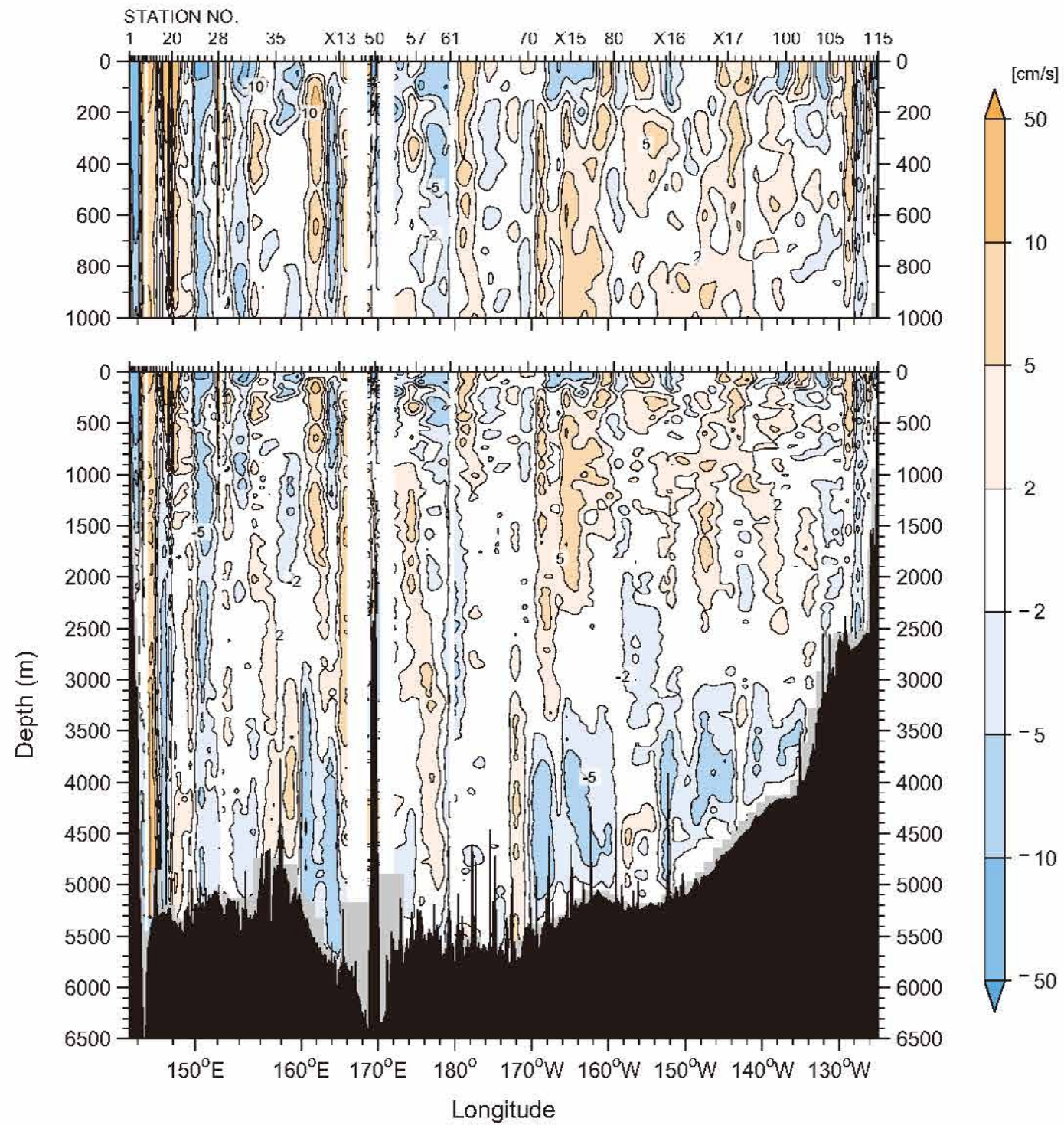

Figure 25

Current velocity (cm/s) normal to the cruise track measured by LADCP (northward is positive)

(a) WHP-P01



(b) WHP-P14

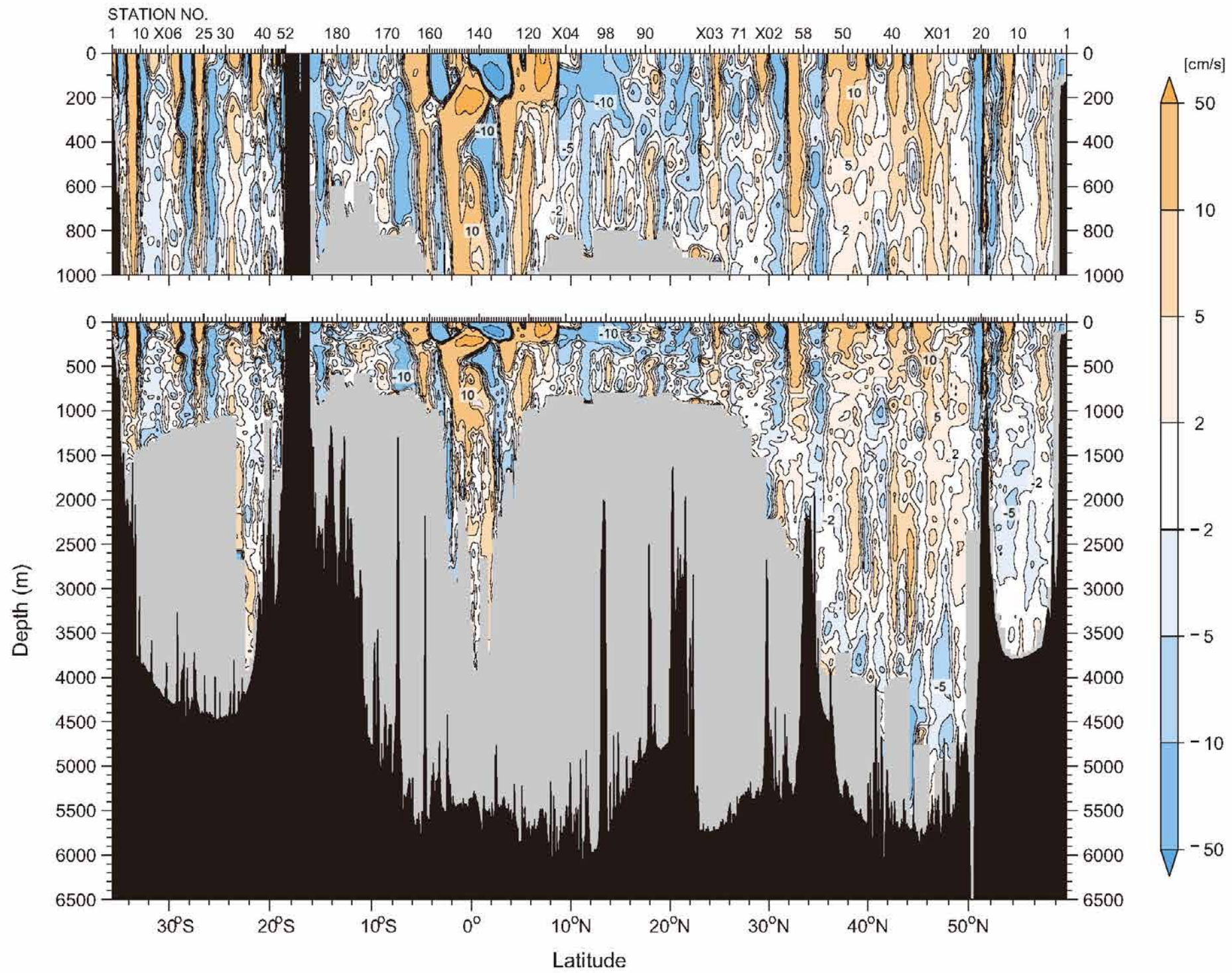
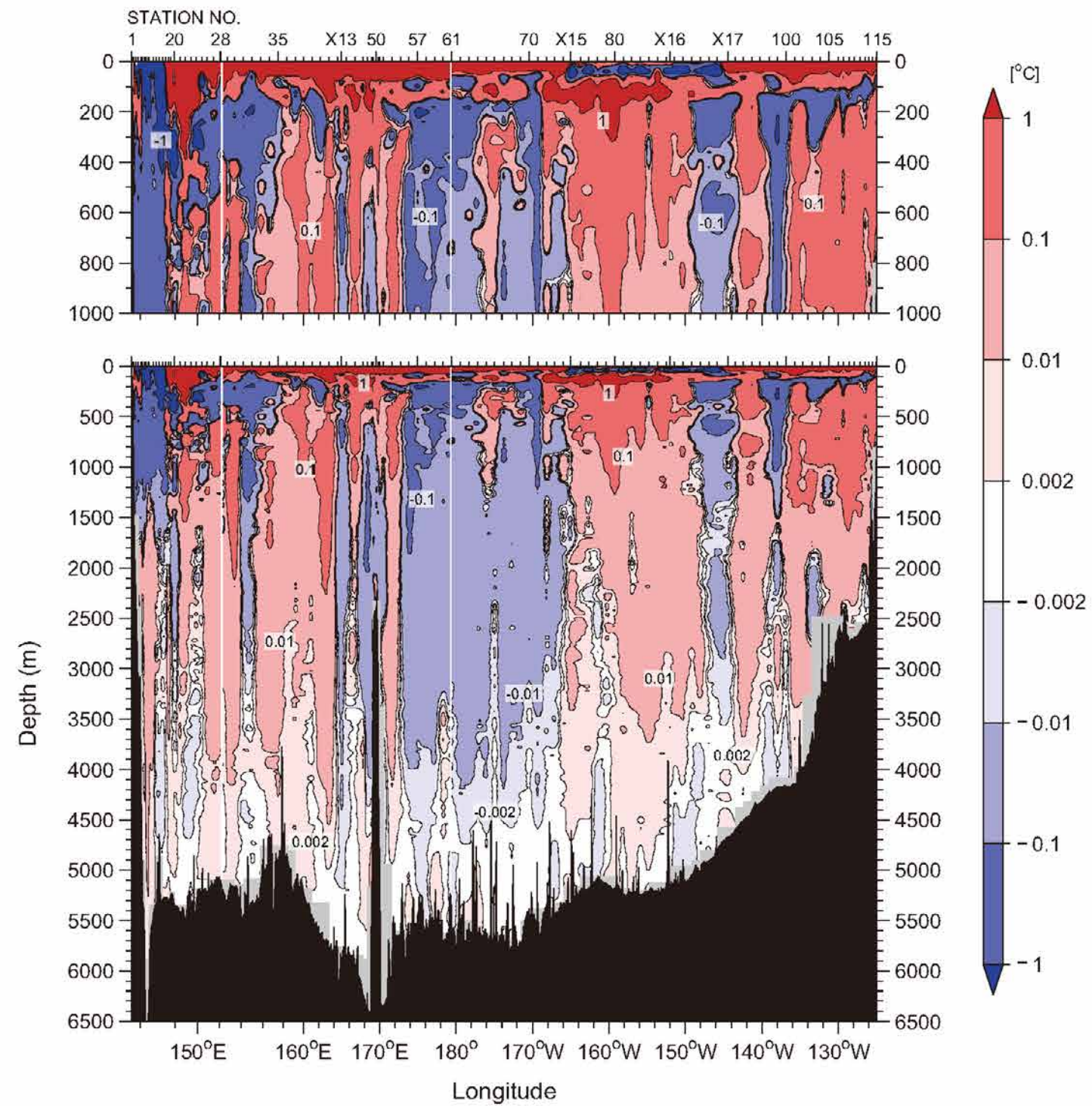

Figure 26

Difference in potential temperature ($^{\circ}\text{C}$) between results from WOCE and its revisit cruise the cruise

(a) WHP-P01



(b) WHP-P14

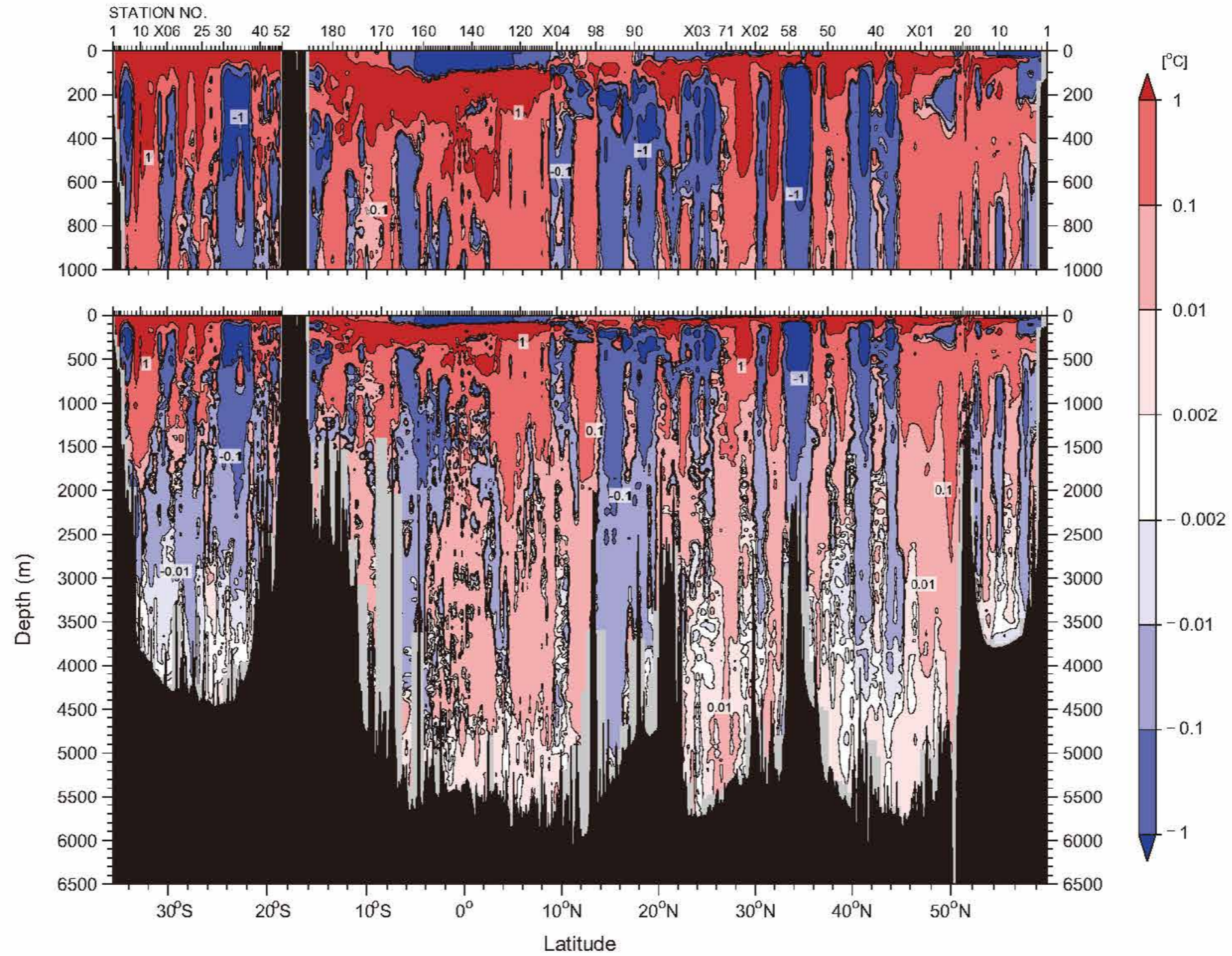
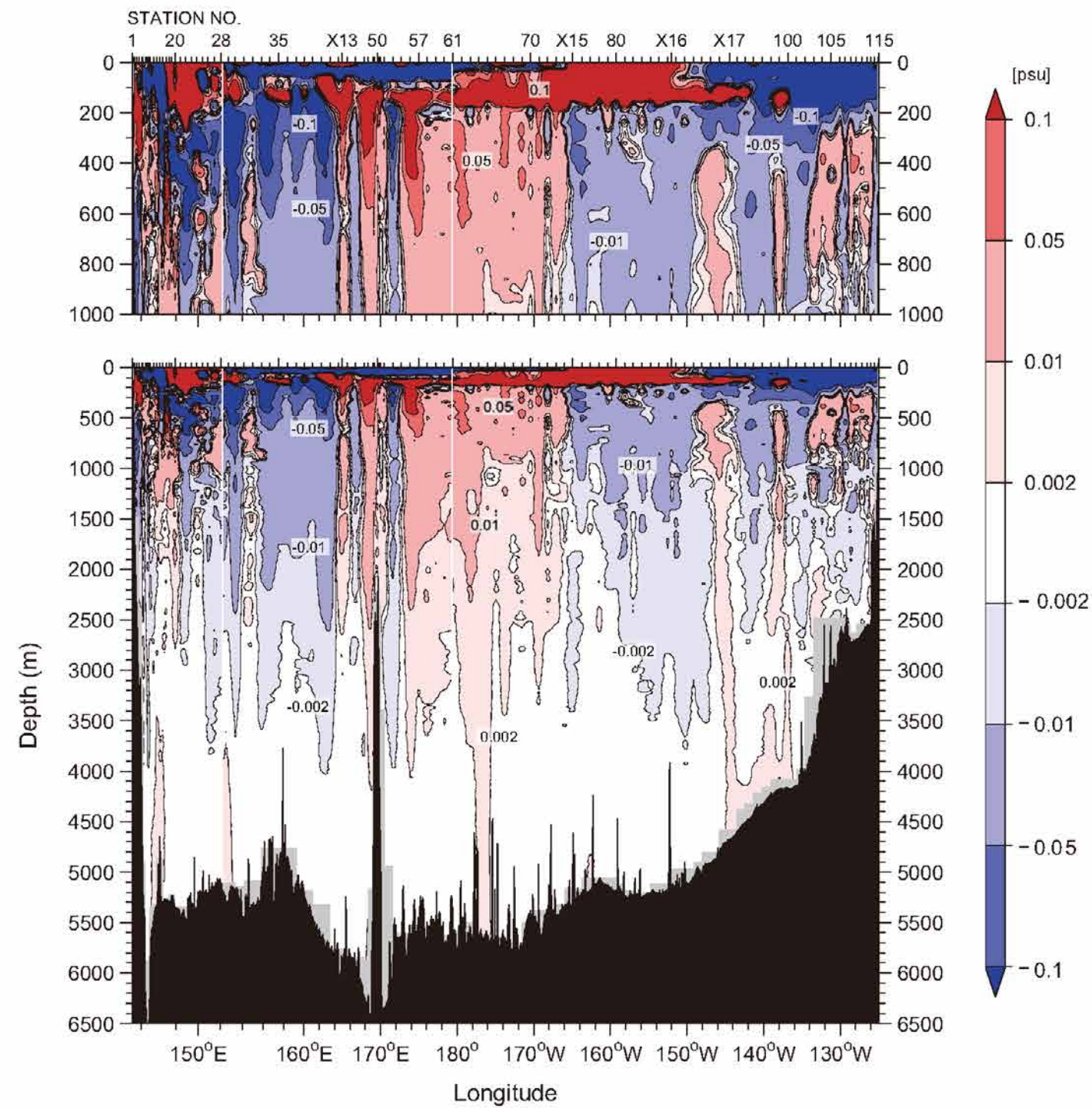

Figure 27

Difference in salinity (psu) between results from WOCE and its revisit cruise the cruise

(a) WHP-P01



(b) WHP-P14

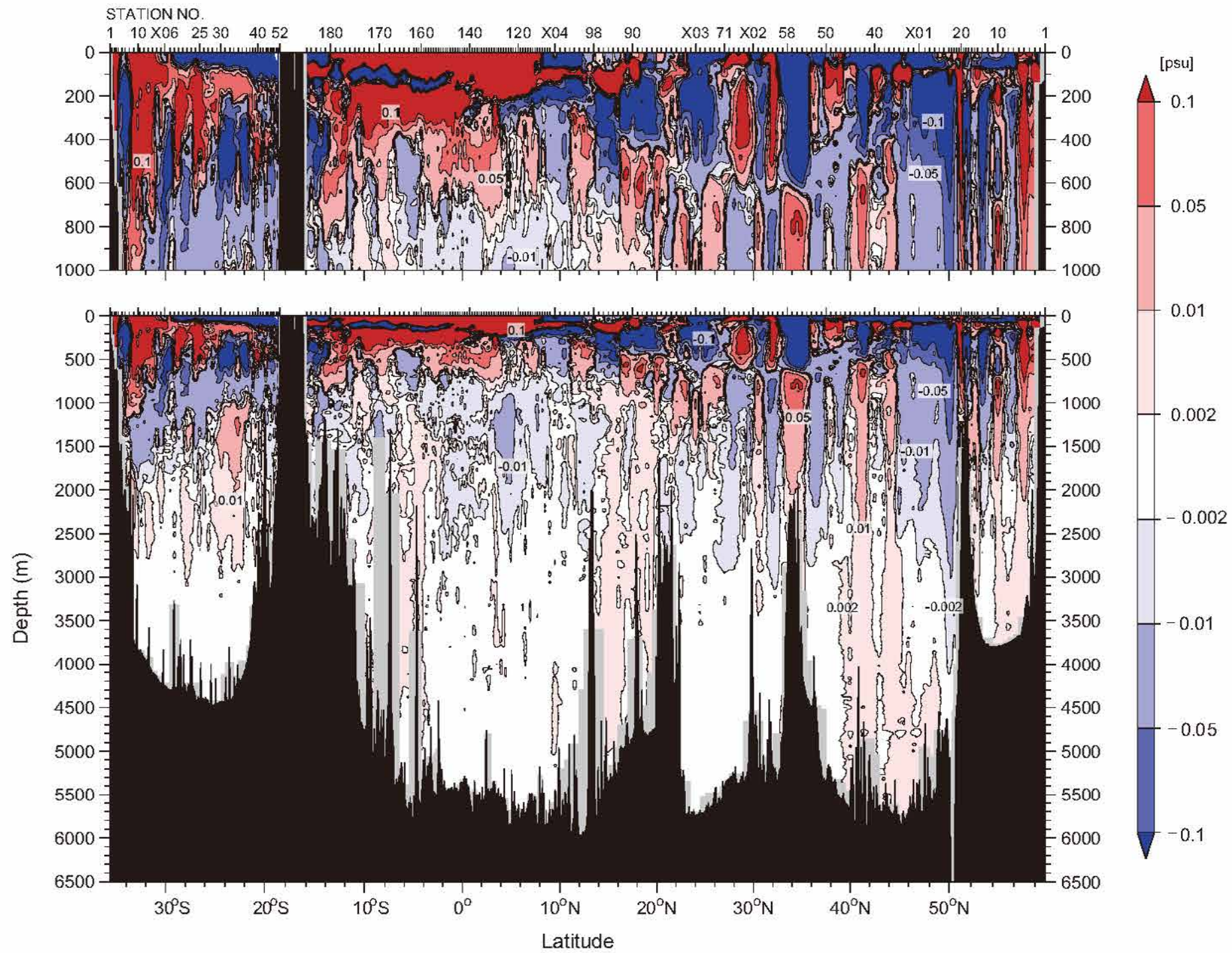
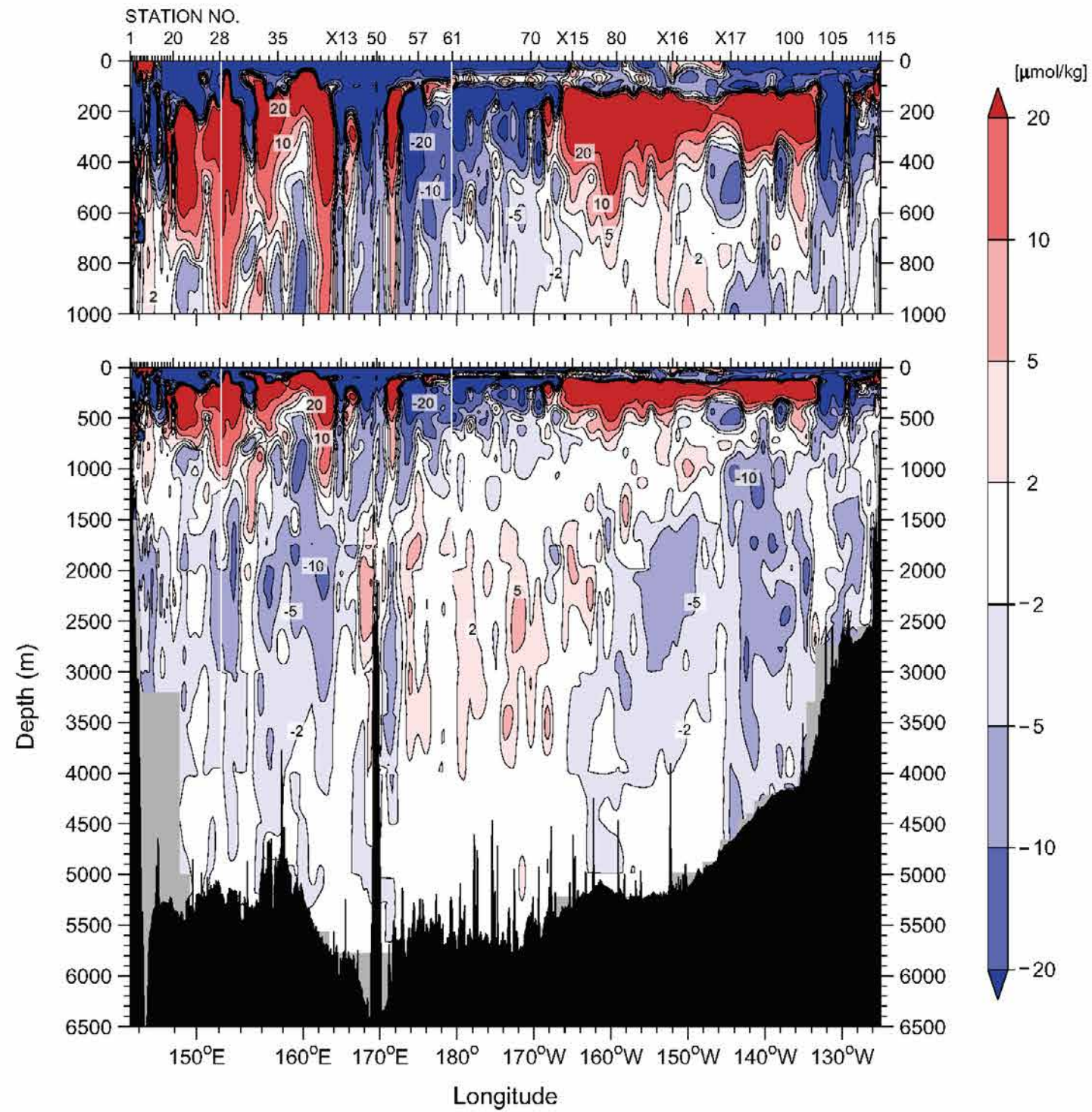

Figure 28

**Difference in dissolved oxygen ($\mu\text{mol/kg}$) between results from WOCE and its revisit cruise the cruise
(a) WHP-P01**



(b) WHP-P14

