

R/V Mirai Cruise Report

MR04-05

September 1 — October 12, 2004

(Dutch Harbor ~ Dutch Harbor)



J W A C S

JWACS

(Joint Western Arctic Climate Studies)

Contents

Preface	1
1. Outline of MR04-05	3
1.1. Cruise summary.....	3
1.2. Cruise track.....	5
1.3. Participant list.....	6
2. General observations	8
2.1. Meteorological observations.....	8
2.1.1 Surface meteorological parameters.....	8
2.2. Physical oceanographic observations.....	15
2.2.1 CTD cast and water sampling.....	15
2.2.2. Sample salinity measurements.....	33
2.2.3. Shipboard ADCP observation.....	36
2.2.4. XCTD observations.....	54
2.3. Sea surface monitoring.....	57
2.4. Oxygen measurements.....	60
2.5. Nutrients.....	65
2.5.1 Water column nutrients.....	65
2.5.2 Sea surface nutrients.....	71
2.6. Partial pressure of CO ₂ (pCO ₂) measurement.....	73
2.7. Total dissolved inorganic carbon measurement.....	75
2.8. Total alkalinity.....	77
2.9. <i>Water sampling inventory</i>	80
3. Ocean Biology	83
3.1. Zooplankton survey.....	83
3.2. Population structure study of <i>Calanus glacialis</i> using the mitochondrial DNA gene (16srRNA).....	89
3.3. Bio-optical observation.....	91
4. Barium	97
5. Carbon-13, oxygen-18, dissolved inorganic carbon, and methane	99
6. Underway geophysical observations	101
6.1. Swath bathymetry.....	101
6.2. Sea surface gravity.....	102
7. Meteorological observation	103
7.1. Cloud science study over the Arctic Sea.....	103
7.2. Surface atmospheric turbulent flux.....	109

Preface

MR04-05 was conducted as a part of the Joint Western Arctic Climate Studies (JWACS) project led by JAMSTEC and Department of Fishery and Ocean Canada. To investigate the Arctic climate system and on-going changes, JWACS 2004 field experiments occupied full span of the southern Canada Basin using two vessels. A heavy ice breaker CCGS Louis S. St-Laurent mainly occupied ice-covered deep Canada Basin east of the Northwind Ridge to identify structure of oceanic Beaufort Gyre and to investigate freshwater storage within the gyre. The source waters comprising the upper oceanic circulation gyre above the main halocline (~ 34.0 psu) are delivered from the shelf regions surrounding the Arctic basins. Pacific water through the Bering Strait, East Siberian Shelf water, melt and river waters are the key water masses. The science mission of the MR04-05 among the JWACS project is to identify the source waters consisting of the oceanic Beaufort Gyre and to identify the gateways and pathways of the source waters from the shelf region into the basin, and to monitor the variation of the source waters using mooring stations and sustainable hydrographic stations.

During the non-icebreaker Mirai cruise, MR04-05, we fortunately met the second recorded maximum sea ice retreat in the Pacific side of Arctic Ocean north of the Bering Strait. As for the maximum ice retreat toward west, 2004 was recorded sea ice retreat year. Especially the open water area extended westward substantially beyond the Mendeleev Ridge. Such kind of westward sea ice retreat has never been seen before 2003. At the first stage of the MR04-05 cruise, we tried to enter the western Canada Basin and in the conjunction area between East Siberian Sea slope and Mendeleev Ridge to investigate the contribution of East Siberian Sea Water and to clarify the contribution of lower halocline water via the East Siberian Sea Slope. We found the oxygen poor lower halocline water entered the western Canada Basin along the slope. The lower halocline water in Beaufort Sea east of the Northwind Ridge is a mixture between the oxygen poor water and another oxygen rich water delivered from northwestern Canada Basin. We also found one missing temperature minimum water with salinity about 32.0 psu. This type of water is also delivered via the East Siberian Sea slope into the southern margin of the western Canada Basin. A temperature maximum water with salinity about 32.5 psu has been recognized as one of temperature maximum water delivered from Pacific via the western Chukchi shelf. However, the hydrographic data of MR04-05 indicated that the temperature maximum water is a kind of apparent temperature maximum being established by the penetration of two temperature minimum waters at near 32.0psu and 33.1 psu.

After the survey in the western area, our mission moved to the Chukchi Borderland area

downstream of the Herald Canyon to investigate role of the complex seafloor topography on the water mass distribution and associated biogeochemical properties. At the northernmost station, we could identify the oxygen rich lower halocline water into the Chukchi Borderland region along the flanks of the seamounts. The complex topography enhanced water mass mixings and delivered new type of water masses to the downstream Beaufort Sea.

At the final stage of MR04-05 cruise, we conducted zigzag hydrographic sections from the Northwind Ridge to the Alaskan Beaufort Sea, to investigate the spreading mechanism and pathway of the Pacific Water into the deep Canada Basin. The dense spacing observation combined with continuous underway ADCP and surface water monitoring data enable to us to study the role of synoptic scale eddies on the large scale circulation of the Canada Basin.

The data acquired by MR04-05 cruise would be a milestone among the Arctic Ocean science history. I am very indebted to Captain Akamine and all crews of R/V Mirai, onboard and offboard marine technicians belonged to MWJ and GODI, and all participants who create the MR04-05 cruise together.

Mr04-05 chief scientist

Koji Shimada

1. Outline of MR04-05

1.1. Cruise Summary

1.1.1 Ship

R/V Mirai	
L x B x D	128.58m x 19.0m x 13.2m
Gross Tonnage	8,672 tons
Call Sign	JNSR

1.1.2 Cruise Code

MR04-05

1.1.3 Project Name

Studies on Arctic Ocean circulation linked to Arctic climate system

1.1.4 Undertaking Institute

Japan Agency for Marine-Earth Science and Technology (JAMSTEC)
2-15 Natsushima-cho, Yokosuka 237-0061, Japan

1.1.5 Chief Scientist

Koji Shimada (JAMSTEC)

1.1.6 Periods and Ports of Call

Sep. 1, 2004 – Oct. 12, 2004
(Dutch Harbor ~ Dutch Harbor)

1.1.7 Observation Summary

CTD (+ water sampling)	150 stations
CTD (only)	98 stations
XCTD	114 stations
ADCP Observation	Continuously
Oceanic Environment Monitoring	Continuously
Surface Meteorology	Continuously
Plankton Net Sampling(Multi layer)	4 stations
Plankton Net Sampling(Single layer)	9 stations
Sea Floor Topography (Seabeam)	Continuously
Tethered balloon Launching	3 times
Radiosonde Launching	69 times
Doppler Radar Observation	Continuously
Aerosol measurement	Continuously
Dual polarization lidar	Continuously
Cloud radar	Continuously

Turbulent flux measurement
Geophysical Parameters

Continuously
Continuously

1.1.8 Data Policy

All data obtained during this cruise will be under the control of the Data Management Office (DMO) of JAMSTEC.

1.2. Cruise track

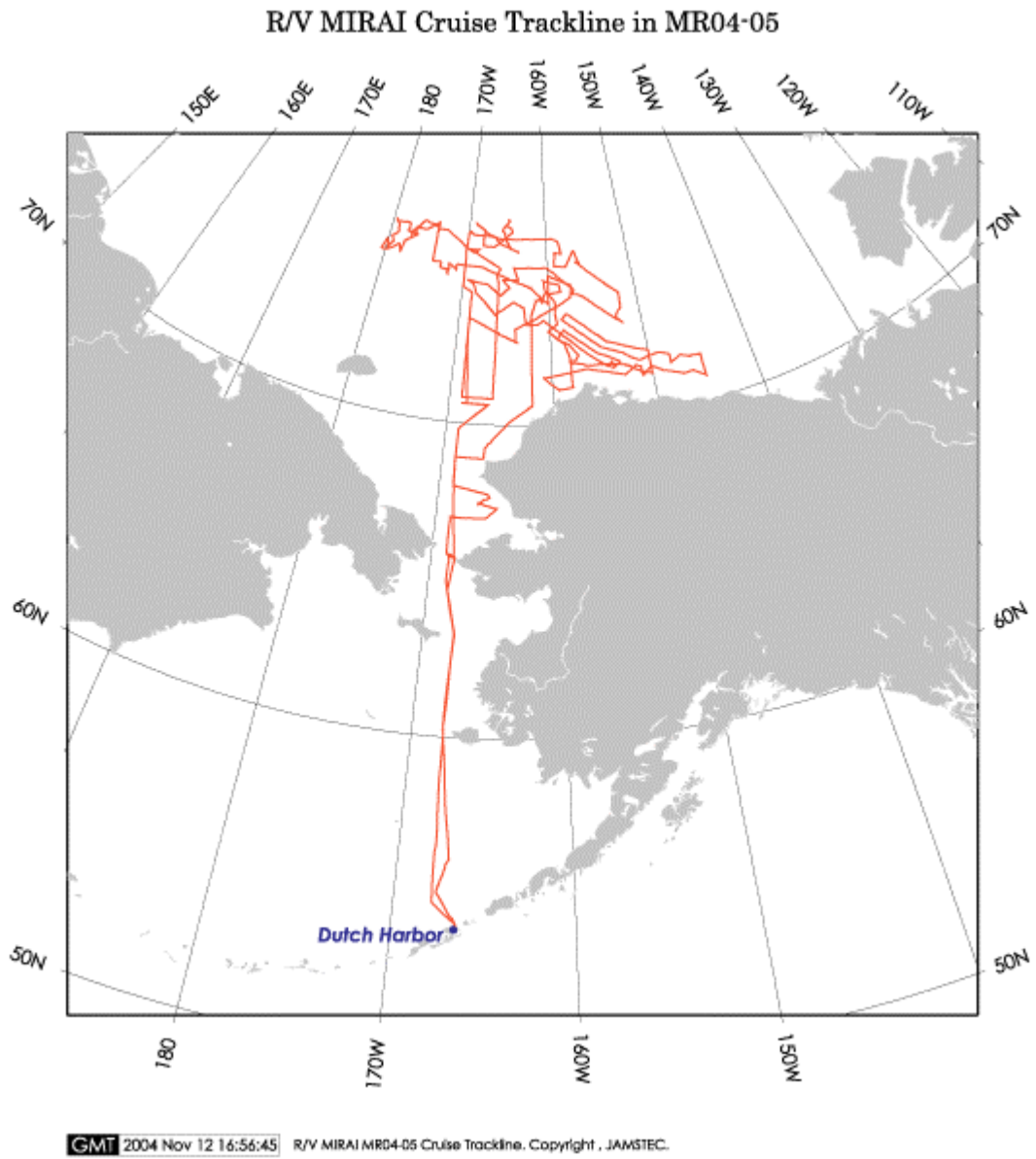

1.3. Participant List

Name	Affiliation	
scientists		(9.1-10.12)
Koji Shimada	JAMSTEC / IORGC	Dutch Harbor ~ Dutch Harbor
Shigeto Nishino	JAMSTEC / IORGC	
Sanae Chiba	JAMSTEC / FORSGC	
Takashi Kamoshida	System Intech Co.,Ltd	
Hisashi Narita	Tokai Univ.	
Yasushi Fujiyoshi	Hokkaido Univ.	
Atsushi Matsuoka	Hokkaido Univ.	
Takashi Hagiwara	Toyama Univ.	
Johanna Jenkins	Dept.of Fisheries and Oceans Canada	
Bruno Jayme	University of Victoria,Canada	
Hirokatsu Uno	MWJ	
Takeo Matsumoto	MWJ	
Tomoyuki Takamori	MWJ	
Kenichi Katayama	MWJ	
Akinori Murata	MWJ	
Takuhei Shiozaki	MWJ	
Eiji Watanabe	MWJ	
Ayumi Takeuchi	MWJ	
Hideki Yamamoto	MWJ	
Mikio Kitada	MWJ	
Kenichiro Sato	MWJ	
Taeko Ohama	MWJ	
Minoru Kamata	MWJ	
Takayoshi Seike	MWJ	
Yuichi Sonoyama	MWJ	
Kohei Miura	MWJ	
Mayu Fujita	MWJ	
Shinichiro Yokogawa	MWJ	
Asako Moro	MWJ	
Masaki Moro	MWJ	
Yoshiko Ishikawa	MWJ	
Soichiro Sueyoshi	GODI	
Shinya Okumura	GODI	
Katsuhisa Maeno	GODI	
Kazuho Yoshida	GODI	

CREW MEMBER LIST

NAME		POSITION	
MASAHARU	AKAMINE	CAPTAIN	
TAKAHIRO	SAKOTA	CHIEF	OFFICER
SHINGO	FUJITA	FIRST	OFFICER
KEN	YASUI	SECOND	OFFICER
TAKEYUKI	FUKASAWA	THIRD	OFFICER
KEITARO	INOUE		OFFICER
TOKURO	KOBAYASHI		OFFICER
KOICHI	HIGASHI	CHIEF	ENGINEER
SHINJI	TOKUNAGA	FIRST	ENGINEER
KOJI	MASUNO	SECOND	ENGINEER
YOSHIHISA	KATO	THIRD	ENGINEER
TOSHIYUKI	IGATA		ENGINEER
KEIICHIRO	SHISHIDO	CHIEF	OPERATOR
NAOTO	MORIOKA	SECOND	OPERATOR
KENETSU	ISHIKAWA	BOATSWAIN	
HISASHI	NARUO	ABLE	SEAMAN
SEIICHIRO	KAWATA	ABLE	SEAMAN
KEIJI	YAMAUCHI	ABLE	SEAMAN
TSUYOSHI	SATO	ABLE	SEAMAN
MASARU	SUZUKI	ABLE	SEAMAN
TSUYOSHI	MONZAWA	ABLE	SEAMAN
SYUJI	KOMATA	ABLE	SEAMAN
MASASHIGE	OKADA	ABLE	SEAMAN
TAKEHARU	AISAKA	ABLE	SEAMAN
KUNHIKO	OMOTE	ABLE	SEAMAN
YOSUKE	KUWABARA	ABLE	SEAMAN
YUKITOSHI	HORIUCHI	NO. 1	OILER
SADANORI	HONDA	OILER	
TAKASHI	MIYAZAKI	OILER	
YOSHIHIRO	SUGIMOTO	OILER	
TAISUKE	TANIGUCHI	OILER	
KIYOHARU	EMOTO	OILER	
KAZUMI	YAMASHITA	OILER	
HITOSHI	OTA	CHIEF	STEWARD
HATSUJI	HIRAISHI	COOK	
TATSUYA	HAMABE	COOK	
KOZO	UEMURA	COOK	
KITOSHI	SUGIMOTO	COOK	
RYOJI	TAKESAKO	COOK	
WATARU	SASAKI	COOK	

2. General observations

2.1. Meteorological observations

2.1.1 Surface meteorological parameters

(1) Personnel

Koji Shimada (JAMSTEC) : Principal Investigator
Souichiro Sueyoshi (Global Ocean Development Inc.) : Operation Leader
Shinya Okumura (GODI)
Katsuhisa Maeno (GODI)
Kazuho Yoshida (GODI)
Not on-board:
Kunio Yoneyama (JAMSTEC) : Principal Investigator
R. Michael Reynolds (Brookhaven National Laboratory, USA)

(2) Objectives

The surface meteorological parameters are observed as a basic dataset of the meteorology. These parameters bring us the information about the temporal variation of the meteorological condition surrounding the ship.

(3) Methods

The surface meteorological parameters were observed throughout the MR04-05 cruise from the departure of Dutch Harbor on 1 September 2004 to arrival of Dutch Harbor on 12 October 2004.

At this cruise, we used two systems for the surface meteorological observation.

1. Mirai meteorological observation system
2. Shipboard Oceanographic and Atmospheric Radiation (SOAR) System

(3-1) Mirai meteorological observation system

Instruments of Mirai meteorological system (SMET) are listed in Table 1 and measured parameters are listed in Table 2. Data was collected and processed by KOAC-7800 weather data processor made by Koshin-Denki, Japan. The data set has 6-second averaged.

(3-2) Shipboard Oceanographic and Atmospheric Radiation (SOAR) system

SOAR system designed by BNL consists of major 3 parts.

1. Portable Radiation Package (PRP) designed by BNL – short and long wave downward radiation.
2. Zeno meteorological system designed by BNL – wind, air temperature, relative humidity, pressure, and rainfall measurement.
3. Scientific Computer System (SCS) designed by NOAA (National Oceanic and Atmospheric Administration, USA)- centralized data acquisition and logging of all data sets.

SCS recorded PRP data every 6 seconds, Zeno/met data every 10 seconds. Instruments and their locations are listed in Table 3 and measured parameters are listed in Table 4.

(4) Preliminary results

Figure 1 show the time series of the following parameters: Wind (SOAR), air temperature (SOAR), sea surface temperature (EPCS), relative humidity (SOAR), precipitation (SMET), short wave radiation (SOAR), infra-red radiation (SOAR), pressure (SOAR) and significant wave height (SMET).

(5) Data archives

The raw data obtained during this cruise will be submitted to JAMSTEC Data Management Division. Corrected data sets will also be available from K. Yoneyama of JAMSTEC.

(6) Remarks

1. We used EPCS (external machine), for sea surface temperature data.
2. We could not collect the SOAR data, due to changing SCS file from 00:08 UTC 23 to 00:28 UTC 23 SEP. 2004.
3. Wind direction and wind speed of SOAR are invalid, due to Anemometer icing from 07:08 UTC to 13:52 UTC 20 SEP. 2004.
4. Navigation data of SOAR (Gyro and LogSpeed) are invalid, due to network server trouble from 21:46 UTC to 22:12 UTC 26 SEP. 2004.
5. We had cleaned and maintained sensors from 21:00 UTC to 23:00 UTC 12 OCT. 2004.
6. Fast rotating shadowband radiometer was operated in Low mode from 00:08 10 SEP. 2004 to 01:19 09 OCT. 2004.
7. Under high humidity condition, relative humidity data (SMET starboard) showed a higher tendency than other data (SMET port and SOAR) during this cruise.

Table 2.1.1-1 Instruments and installations of Mirai meteorological system

Sensors	Type	Manufacturer	Location (altitude from surface)
Anemometer	KE-500	Koshin Denki, Japan	foremast (24m)
Thermometer	HMP45A	Vaisala, Finland	compass deck (21m)
	with 43408 Gill aspirated radiation shield	(R.M. Young)	
	RFN1-0	Koshin Denki, Japan	4th deck (-1m, inlet -5m) SST
Barometer	F-451	Yokogawa, Japan	weather observation room
			captain deck (13m)
Rain gauge	50202	R. M. Young, USA	compass deck (19m)
Optical rain gauge	ORG-815DR	Osi, USA	compass deck (19m)
Radiometer (short wave)	MS-801	Eiko Seiki, Japan	radar mast (28m)
Radiometer (long wave)	MS-202	Eiko Seiki, Japan	radar mast (28m)
Wave height meter	MW-2	Tsurumi-seiki, Japan	bow (10m)

Table 2.1.1-2 Parameters of Mirai meteorological observation system

Parmeter	Units	Remarks
1 Latitude	degree	
2 Longitude	degree	
3 Ship's speed	knot	Mirai log, DS-30 Furuno
4 Ship's heading	degree	Mirai gyro, TG-6000, Tokimec
5 Relative wind speed	m/s	6sec./10min. averaged
6 Relative wind direction	degree	6sec./10min. averaged
7 True wind speed	m/s	6sec./10min. averaged
8 True wind direction	degree	6sec./10min. averaged
9 Barometric pressure	hPa	adjusted to sea surface level 6sec. averaged
10 Air temperature (starboard side)	degC	6sec. averaged
11 Air temperature (port side)	degC	6sec. averaged
12 Dewpoint temperature (starboard side)	degC	6sec. averaged
13 Dewpoint temperature (port side)	degC	6sec. averaged
14 Relative humidity (starboard side)	%	6sec. averaged
15 Relative humidity (port side)	%	6sec. averaged
16 Sea surface temperature	degC	6sec. averaged
17 Rain rate (optical rain gauge)	mm/hr	hourly accumulation
18 Rain rate (capacitive rain gauge)	mm/hr	hourly accumulation
19 Down welling shortwave radiation	W/m ²	6sec. averaged
20 Down welling infra-red radiation	W/m ²	6sec. averaged
21 Significant wave height (fore)	m	hourly
22 Significant wave height (aft)	m	hourly
23 Significant wave period	second	hourly
24 Significant wave period	second	hourly

Table 2.1.1-3 Instruments and installation locations of SOAR system

Sensors	Type	Manufacturer	Location (altitude from surface)
<i>Zeno/Met</i>			
Anemometer	05106	R.M. Young, USA	foremast (25m)
Tair/RH	HMP45A	Vaisala, Finland	foremast (24m)
	with 43408	Gill aspirated radiation shield (R.M. Young)	
Barometer	61201	R.M. Young, USA	foremast (24m)
	with 61002	Gill pressure port (R.M. Young)	
Rain gauge	50202	R. M. Young, USA	foremast (24m)
Optical rain gauge	ORG-815DA	Osi, USA	foremast (24m)
<i>PRP</i>			
Radiometer (short wave)	PSP	Eiko Seiki, Japan	foremast (25m)
Radiometer (long wave)	PIR	Eiko Seiki, Japan	foremast (25m)
Fast rotating shadowband radiometer		Yankee, USA	foremast (25m)

Table 2.1.1-4 Parameters of SOAR system

	Parameter	Units	Remarks
1	Latitude	degree	
2	Longitude	degree	
3	Sog	knot	
4	Cog	degree	
5	Relative wind speed	m/s	
6	Relative wind direction	degree	
7	Barometric pressure	hPa	
8	Air temperature	degC	
9	Relative humidity	%	
10	Rain rate (optical rain gauge)	mm/hr	reset at 50mm
11	Precipitation (capacitive rain gauge)	mm	
12	Down welling shortwave radiation	W/m ²	
13	Down welling infra-red radiation	W/m ²	
14	Defuse irradiance	W/m ²	

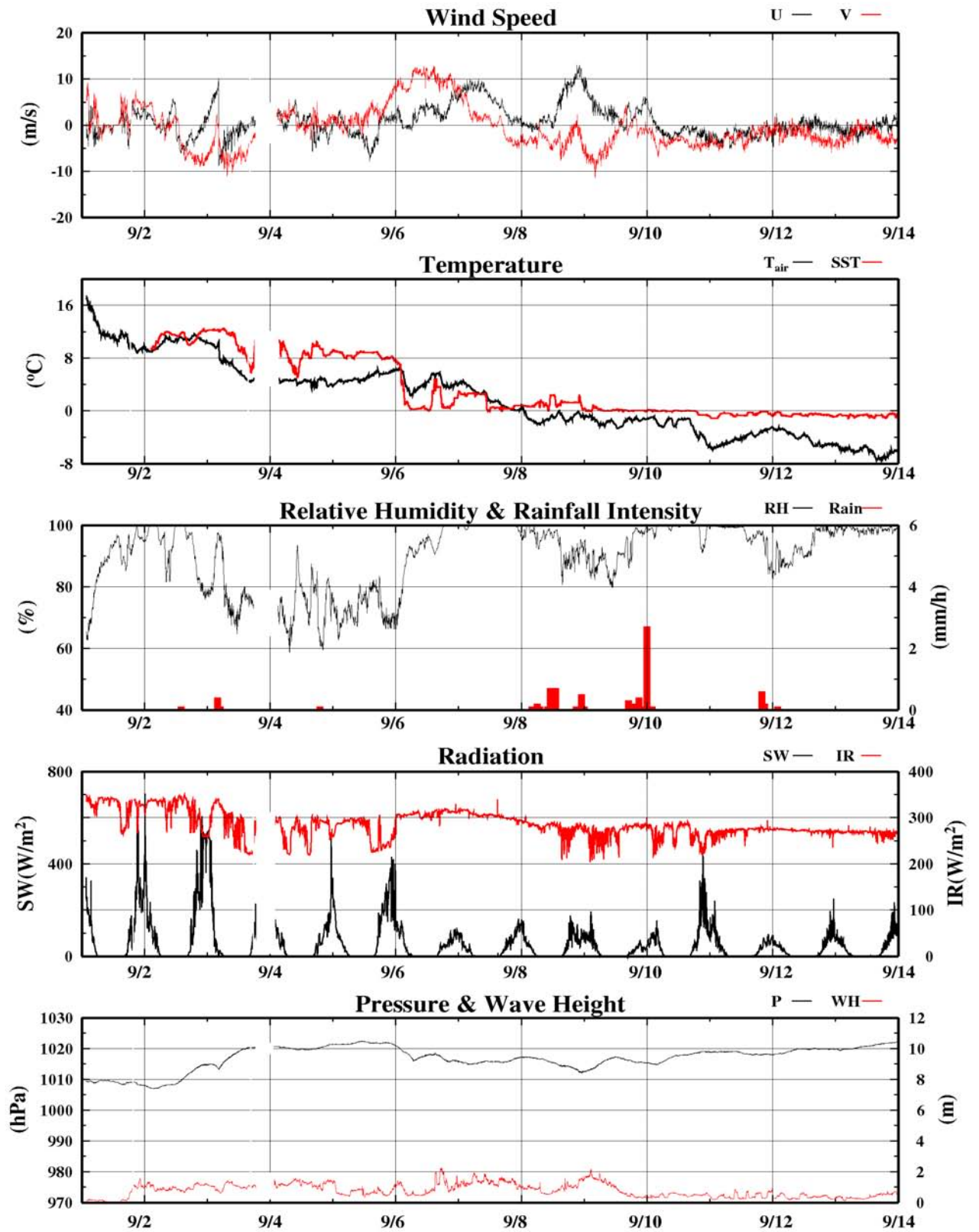

Fig. 2.1.1-1 Time series of surface meteorological parameters during the cruise

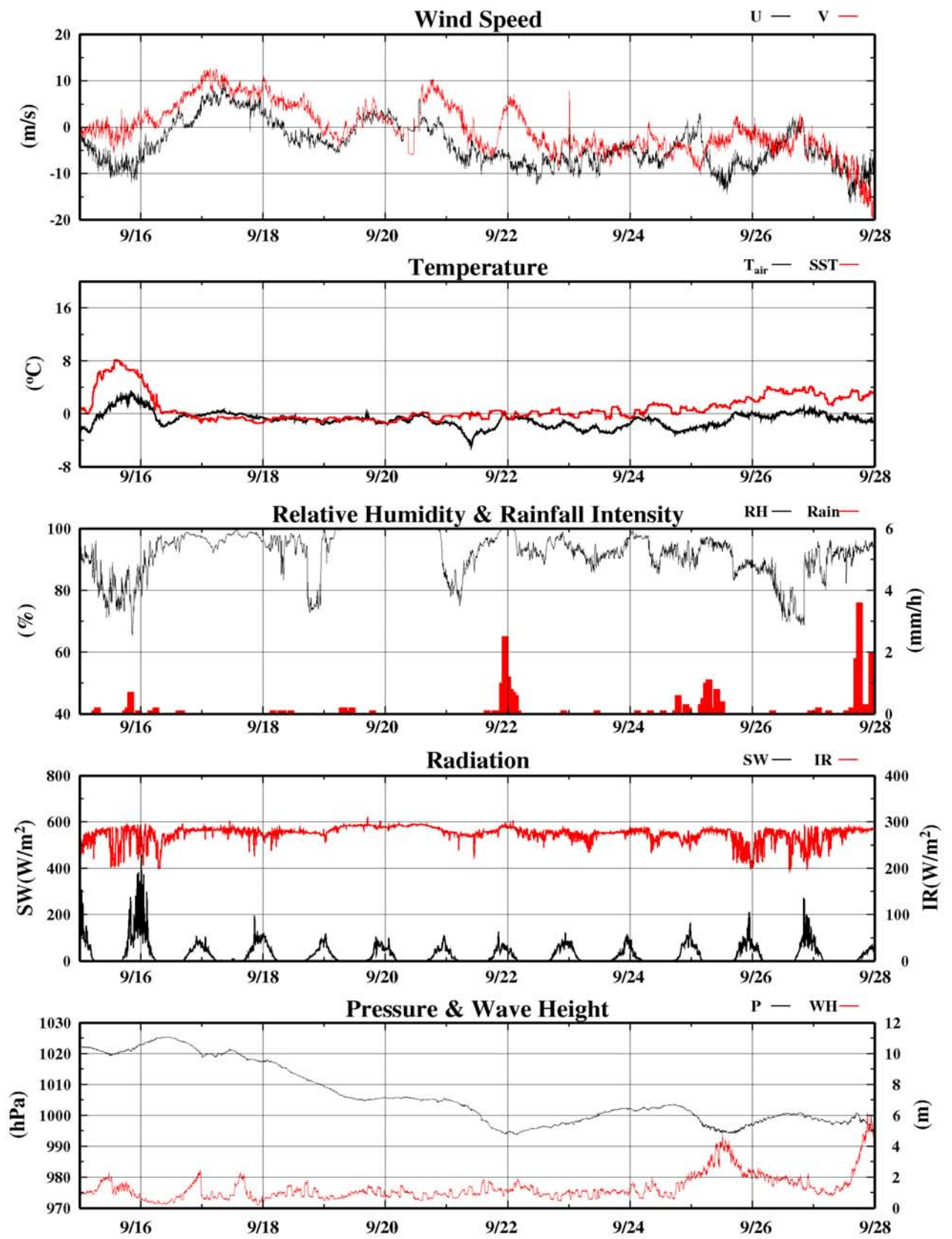

Fig. 2.1.1-1 continued

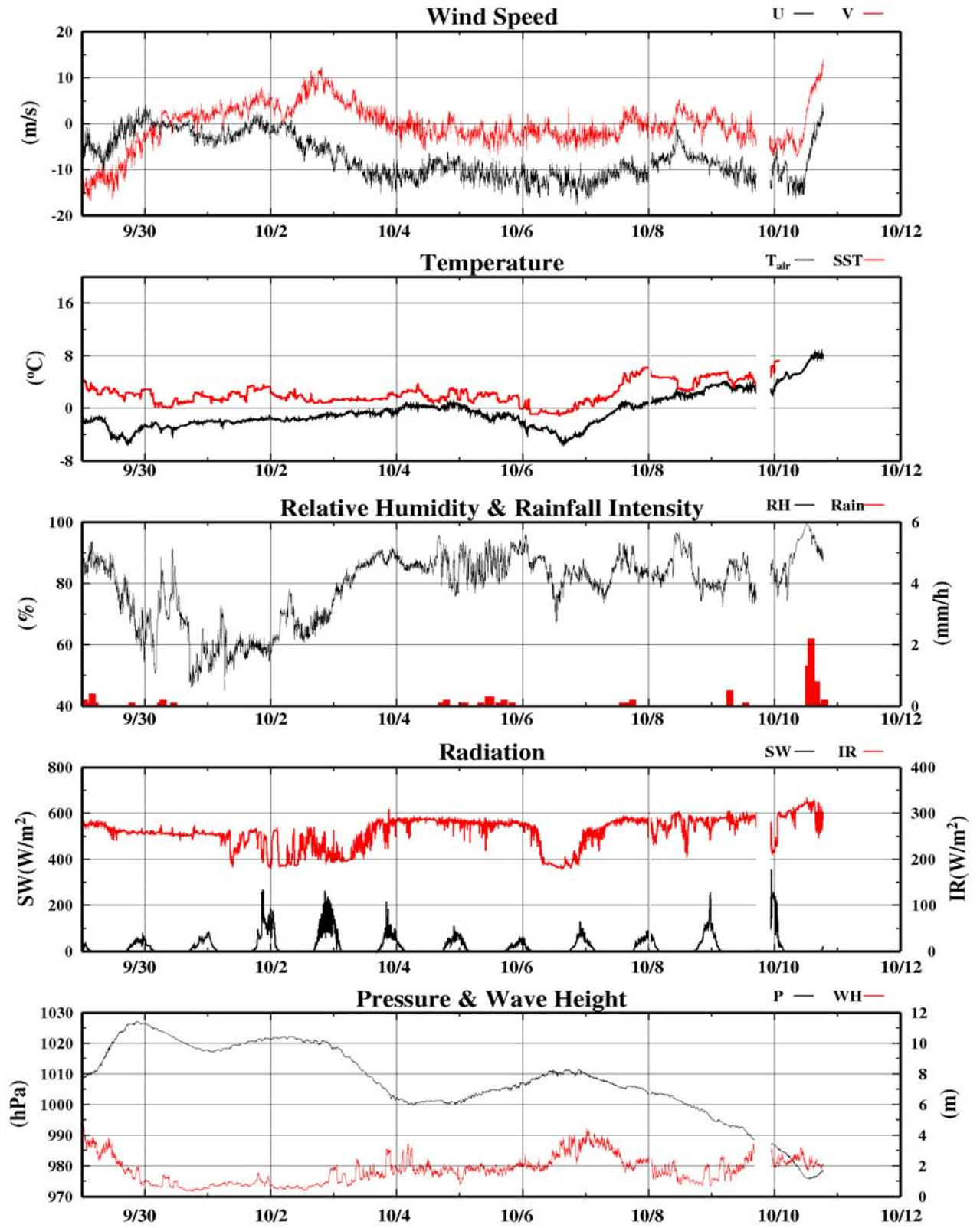

Fig. 2.1.1-1 continued

2.2. Physical oceanographic observations

2.2.1 CTD cast and water sampling

(1) Personnel

Koji Shimada	(JAMSTEC) : Principal Investigator
Shigeto Nishino	(JAMSTEC) : Scientist
Tomoyuki Takamori	(MWJ) : Operation Leader
Takeo Matsumoto	(MWJ)
Hirokatsu Uno	(MWJ)
Akinari Murata	(MWJ)

(2) Objective

Investigation of oceanic structure.

(3) Parameters

Temperature (Primary and Secondary)
Conductivity (Primary and Secondary)
Pressure
Dissolved Oxygen (Primary and Secondary)
Fluorescence
Transmissiometer

(4) Instruments and Methods

CTD/Carousel Water Sampling System, which is a 36-position Carousel water sampler (CWS) with Sea-Bird Electronics Inc. CTD (SBE9plus), was used during this cruise. 12-liter Niskin Bottles were used for sampling seawater. The sensors attached on the CTD were temperature (Primary and Secondary), conductivity (Primary and Secondary), pressure, D.O. (Primary and Secondary) and fluorometer, transmissometer, altimeter sensors. Salinity was calculated by measured values of pressure, conductivity and temperature. The CTD/CWS was deployed from starboard on working deck.

The CTD raw data were acquired on real time using the Seasave-Win32 (ver.5.27b) provided by Sea-Bird Electronics, Inc. and stored on the hard disk of the personal computer. Seawater was sampled during up-cast by sending fire commands from the personal computer. We sampled seawater to calibrate salinity data.

Measurement depth was about to 5m above the bottom of the sea. Total 248 casts of CTD measurements have been carried out. (See table 2.2.1)

Data processing procedures and used utilities SBE Data Processing-Win32 (ver.5.27b) and SEASOFT of were as follows:

DATCNV converted the raw data to scan number, pressure, depth, temperatures, conductivities, oxygen voltage, and descent rate, altitude, fluorescence, transmission. DATCNV also extracted bottle information where scans were marked with the bottle confirm bit during acquisition. The duration was set to 4.4 seconds, and the offset was set to 0.0 seconds.

ROSSUM created a summary of the bottle data. The bottle position, date, time were output as the first two columns. Scan number, pressure, depth, temperatures, conductivities,

oxygen voltage, and altitude, fluorescence, transmission were averaged over 4.4 seconds.

ALIGNCTD converted the time-sequence of oxygen sensor outputs into the pressure sequence to ensure that all calculations were made using measurements from the same parcel of water. For a SBE 9plus CTD with the ducted temperature and conductivity sensors and a 3000 rpm pump, the typical net advance of the conductivity relative to the temperature is 0.073 seconds. So, the SBE 11plus deck unit was set to advance the conductivity for 1.73 scans ($1.75/24 = 0.073$ seconds). Oxygen data are also systematically delayed with respect to depth mainly because of the long time constant of the oxygen sensor and of an additional delay from the transit time of water in the pumped plumbing line. This delay was compensated by 6 seconds advancing oxygen sensor output (oxygen voltage) relative to the pressure.

WILDEDIT marked extreme outliers in the data files. The first pass of WILDEDIT obtained an accurate estimate of the true standard deviation of the data. The data were read in blocks of 1000 scans. Data greater than 10 standard deviations were flagged. The second pass computed a standard deviation over the same 1000 scans excluding the flagged values. Values greater than 20 standard deviations were marked bad. This process was applied to pressure, temperatures, conductivities, oxygen voltage and altimeter, fluorescence, transmission outputs.

CELLTM used a recursive filter to remove conductivity cell thermal mass effects from the measured conductivity. Typical values used were thermal anomaly amplitude $\alpha = 0.03$ and the time constant $1/\beta = 7.0$.

FILTER performed a low pass filter on pressure with a time constant of 0.15 seconds. In order to produce zero phase lag (no time shift) the filter runs forward first then backwards.

WFILTER performed a median filter to remove spikes in the fluorescence and transmission data. A median value was determined from a window of 49 scans.

SECTION selected a time span of data based on scan number in order to reduce a file size. The minimum number was set to be the starting time when the CTD package was beneath the sea-surface after activation of the pump. The maximum number was set to be the end time when the package came up from the surface. (Data to check the CTD pressure drift were prepared before SECTION.)

LOOPEDIT marked scans where the CTD was moving less than the minimum velocity of 0.0 m/s (traveling backwards due to ship roll).

DERIVE was used to compute oxygen.

BINAVG averaged the data into 1dbar pressure bins. The center value of the first bin was set equal to the bin size. The bin minimum and maximum values are the center value plus and minus half the bin size. Scans with pressures greater than the minimum and less than or equal to the maximum were averaged. Scans were interpolated so that a data record exists every dbar.

DERIVE was re-used to compute salinity, potential temperature, and sigma-theta.

SPLIT was used to split data into the down cast and the up cast.

Configuration file

MR04K05a.con to Stn.A04001-A04006.

MR04K05b.con from Stn.A04007-A04250.

Specifications of the sensors are listed below.

CTD : SBE911plus CTD system

Under water unit :

SBE9plus (S/N 09P79492-0575, Sea-bird Electronics, Inc.)

• Pressure sensor : Digiquartz pressure sensor (S/N 79492)

Calibrated Date: 30 Jul.2004

Temperature sensors :

Primary : SBE3 (S/N 034372, Sea-bird Electronics, Inc.)

Calibrated Date: 01 Jan. 2004

Secondary : SBE03-04/F (S/N 031364, Sea-bird Electronics, Inc.)

Calibrated Date: 24 Jun. 2004

Conductivity sensors :

Primary : SBE04C (S/N 042926, Sea-bird Electronics, Inc.)

Calibrated Date: 19 Dec. 2003

Secondary : SBE04-04/0 (S/N 041206, Sea-bird Electronics, Inc.)

Calibrated Date: 24 Jun. 2004

D.O. sensor :

Primary : SBE43 (S/N 430330, Sea-bird Electronics, Inc.)

Calibrated Date: 18 Jun. 2004

Secondary : SBE43(S/N430575, Sea-bird Electronics, Inc.)

Calibrated Date: 10 Jun. 2004

Altimeter : Datasonics PSA-916 (S/N 1100, Benthos, Inc.)

Fluorometer : (S/N 2579, Seapoint Sensors, Inc.)

Transmissometer : (S/N CST-207RD, WET Labs, Inc.)

Deck unit : SBE11plus (S/N 11P9833-0344, Sea-bird Electronics, Inc.).

Carousel water sampler : SBE32 (S/N 3221746-0278, Sea-bird Electronics, Inc.).

(5) Results

See §1.4. Preliminary results. The results are based on the CTD observation of this cruise.

(6) Troubles

Jellyfishes was breathed in T-S duct or Tube at Sta.A04104,A04164,A04203,A04204 (UP cast).

(7)Sensor Characteristic

We used SBE35 temperature sensor for the reference of temperature, and bottle salinity measured by AUTOSAL for the reference of conductivity. Bottle conductivity was calculated by using SBE35 temperature and pressure.

As shown in Fig2.2.1-1 primary temperature sensor had -0.0001deg-C offset. Secondary sensor had 0.0005deg-C offset. Offset value of primary temperature sensor was smaller than secondary. However standard deviation of secondary sensor was smaller than primary. Offset of primary and secondary temperature sensors are not affected by pressure. Both sensors had no drift during this cruise (Fig2.2.1-2). We recommend using secondary sensor.

Primary conductivity sensor is affected by pressure shallower than 2000 db. On the other hand, secondary conductivity sensor is not affected by pressure (Fig2.2.1-3). Primary conductivity sensor had about 0.0001S/m offset at the beginning. It contained about 0.0012S/m drift during this cruise. On the other hand, secondary conductivity sensor had about 0.0005S/m offset and no drift (See Fig2.2.1-4). Therefore, we recommend using secondary conductivity sensor.

(8) Data archives

All raw and processed CTD data files were copied onto CD-ROMs. The data will be submitted to the Data Management Office (DMO), JAMSTEC, and will be opened to public via "R/V MIRAI Data Web Page" in JAMSTEC home page.

Table2.2.1-1 CTD Cast Table

STNNBR	CASTNO	Date(UTC)	Time(UTC)		Start Position		Depth	WIRE	HT ABOVE	Max	Max	CTD data	Remarks
		yyyy/mm/dd	Start	End	Latitude	Longitude		OUT	BOTTOM	Depth	Pressure		
A04006	1	2004/9/4	11:49	12:01	68-05.12N	168-50.45W	51.8	47.8	7.8	50.2	50.2	006M01	1*
A04007	1	2004/9/4	19:22	19:36	69-50.02N	168-49.85W	40.3	39.7	4.9	41.5	42.0	007M01	
A04008	1	2004/9/5	1:00	1:04	70-38.00N	166-15.32W	35.2	34.8	4.3	37.0	37.3	008M01	
A04009	1	2004/9/5	2:04	2:15	70-38.04N	166-45.44W	40.9	39.9	4.9	42.3	42.7	009M01	
A04010	1	2004/9/5	3:19	3:23	70-37.96N	167-15.45W	46.5	45.0	5.2	47.3	47.9	010M01	
A04011	1	2004/9/5	5:02	5:14	70-38.00N	168-15.44W	36.7	35.1	5.6	36.8	37.5	011M01	Date input error(9/4→9/5)
A04012	1	2004/9/5	6:25	6:27	70-37.99N	168-49.96W	28.8	-	3.4	20.6	18.6	012M01	2*
A04015	1	2004/9/6	16:13	16:27	72-40.01N	163-44.07W	50.1	46.1	7.5	48.5	48.8	015M01	
A04016	1	2004/9/6	18:55	19:14	73-03.47N	163-44.74W	102.0	92.7	4.5	94.0	95.3	016M01	
A04017	1	2004/9/6	22:51	23:21	73-19.57N	161-59.59W	169.0	155.5	8.0	157.7	158.2	017M01	Longitude input error(162→161)
A04018	1	2004/9/7	1:13	1:55	73-28.83N	160-59.89W	373.0	366.4	6.9	365.2	369.7	018M01	
A04019	1	2004/9/7	3:34	5:29	73-37.97N	159-59.85W	2257.0	2266.7	9.1	2257.0	2293.1	019M01	
A04020	1	2004/9/7	7:20	9:50	73-47.31N	158-59.97W	3123.0	3139.4	6.4	3119.5	3175.8	020M01	
A04021	1	2004/9/7	12:39	15:27	74-01.01N	157-30.12W	3827.0	3842.6	6.4	3830.6	3906.5	021M01	
A04023	1	2004/9/7	17:45	20:21	74-25.05N	157-20.18W	3860.0	3846.1	11.4	3831.8	3906.3	023M01	
A04024	1	2004/9/8	2:38	4:00	74-29.71N	158-02.76W	1464.0	1452.9	10.8	1448.3	1468.6	024M01	

Table2.2.1-2 CTD Cast Table

STNNBR	CASTNO	Date(UTC)	Time(UTC)		Start Position		Depth	WIRE OUT	HT ABOVE BOTTOM	Max Depth	Max Pressure	CTD data file name	Remarks
		yyyy/mm/dd	Start	End	Latitude	Longitude							
A04025	1	2004/9/8	20:47	21:36	74-22.95N	162-06.01W	1484.0	1478.2	5.1	1473.0	-	025M01	
A04026	1	2004/9/8	23:42	0:22	74-30.98N	163-18.99W	1056.0	1051.1	2.0	1457.7	-	026M01	
A04027	1	2004/9/9	2:18	2:38	74-37.85N	164-25.07W	505.0	490.2	4.1	493.5	499.8	027M01	
A04028	1	2004/9/9	5:46	6:05	74-49.31N	166-15.31W	418.0	405.8	6.5	406.0	410.0	028M01	
A04029	1	2004/9/9	7:56	8:12	74-55.88N	167-19.85W	276.0	265.8	5.6	266.0	269.2	029M01	
A04030	1	2004/9/9	9:35	10:08	74-59.92N	167-59.60W	168.0	-	7.1	155.9	157.5	030M01	
A04031	1	2004/9/9	11:55	12:06	74-59.95N	168-59.98W	216.0	204.0	7.2	204.7	206.1	031M01	
A04032	1	2004/9/9	13:46	14:21	75-00.00N	170-00.38W	256.0	246.7	6.5	247.5	250.2	032M01	
A04033	1	2004/9/9	15:58	16:14	75-00.03N	171-01.12W	316.0	315.8	7.1	315.0	318.7	033M01	Longitude input error(7W→70W)
A04034	1	2004/9/9	17:27	17:39	74-49.97N	171-00.03W	265.0	262.0	4.1	261.0	-	034M01	
A04035	1	2004/9/9	21:18	21:58	74-59.62N	171-58.61W	383.0	375.4	3.0	377.3	381.7	035M01	
A04036	1	2004/9/10	0:34	1:10	74-40.18N	171-59.84W	290.0	283.4	2.9	282.1	-	036M01	
A04037	1	2004/9/10	2:51	3:07	74-47.16N	172-01.15W	324.0	316.7	4.1	314.9	-	037M01	
A04038	1	2004/9/10	4:50	5:06	74-50.02N	173-00.54W	317.0	308.9	3.2	307.7	-	038M01	
A04039	1	2004/9/10	6:18	6:34	75-00.08N	173-00.02W	344.0	338.4	7.5	334.9	338.9	039M01	
A04040	1	2004/9/10	8:20	8:59	74-59.95N	173-59.61W	297.0	-	7.9	287.4	293.8	040M01	
A04041	1	2004/9/10	10:40	11:25	75-14.97N	174-00.13W	401.0	389.3	7.0	389.2	393.6	041M01	
A04042	1	2004/9/10	13:38	14:51	75-24.97N	174-00.36W	1049.0	1040.8	7.6	1034.5	1047.7	042M01	
A04043	1	2004/9/10	17:05	18:28	75-35.15N	174-00.42W	1562.0	1544.3	10.0	1538.4	1560.5	043M01	
A04044	1	2004/9/10	20:45	22:24	75-50.07N	174-00.71W	1994.0	1997.0	10.8	1982.5	213.2	044M01	
A04045	1	2004/9/11	1:07	3:00	76-15.28N	173-57.31W	2221.0	2220.9	8.7	-	2231.9	045M01	
A04046	1	2004/9/11	5:49	7:33	75-56.23N	175-30.63W	2050.0	2053.3	8.6	2039.0	2070.8	046M01	

Table2.2.1-3 CTD Cast Table

STNNBR	CASTNO	Date(UTC)	Time(UTC)		Start Position		Depth	WIRE OUT	HT ABOVE BOTTOM	Max Depth	Max Pressure	CTD data file name	Remarks
		yyyy/mm/dd	Start	End	Latitude	Longitude							
A04047	1	2004/9/11	10:59	12:31	75-43.75N	176-30.04W	1646.0	1640.8	9.7	1631.7	1656.1	047M01	
A04048	1	2004/9/11	14:50	16:03	75-35.72N	177-08.50W	1255.0	1245.1	10.9	1241.1	1258.1	048M01	
A04049	1	2004/9/11	20:39	21:50	75-27.15N	177-52.71W	1027.0	-	9.4	1016.0	1029.4	049M01	
A04050	1	2004/9/12	1:31	2:29	75-18.55N	178-30.18W	825.0	810.9	11.1	808.1	818.3	050M01	Time input error(01:05→01:20)
A40051	1	2004/9/12	6:04	6:50	75-01.72N	179-30.04E	322.0	304.6	7.1	304.2	307.8	051M01	
A04052	1	2004/9/12	8:59	10:07	75-22.06N	179-55.13E	768.0	755.9	7.5	754.6	763.8	052M01	
A04053	1	2004/9/12	12:09	13:00	75-07.01N	179-47.97W	510.0	499.6	7.2	498.2	-	053M01	
A04054	1	2004/9/12	15:52	16:26	75-30.96N	179-35.28W	977.0	963.7	9.3	960.8	973.3	054M01	
A04055	1	2004/9/12	19:46	20:54	75-46.66N	179-04.73W	1129.0	1111.7	20.4	1101.9	1116.8	055M01	
A04056	1	2004/9/13	2:53	3:57	76-02.67N	178-00.08W	991.0	986.8	7.3	981.8	994.7	056M01	
A04057	1	2004/9/13	16:10	17:47	76-02.42N	172-44.77W	2065.0	2059.5	9.0	2052.5	2085.0	057M01	
A04058	1	2004/9/13	20:19	21:48	75-48.28N	171-20.05W	1746.0	1734.7	14.9	1727.0	1752.6	058M01	
A04059	1	2004/9/14	1:45	3:02	75-38.58N	170-26.86W	1395.0	1396.8	9.6	1382.8	1402.3	059M01	
A04060	1	2004/9/14	5:24	6:07	75-25.16N	168-59.80W	250.0	237.2	7.7	237.0	239.8	060M01	
A04061	1	2004/9/14	9:00	9:55	75-32.57N	169-45.04W	564.0	557.1	6.3	555.5	562.1	061M01	
A04062	1	2004/9/14	14:16	14:50	75-09.93N	166-54.58W	293.0	281.0	6.8	280.3	283.5	062M01	
A04063	1	2004/9/14	16:34	17:21	74-59.92N	165-44.68W	521.0	512.0	5.0	510.2	518.0	063M01	
A04064	1	2004/9/14	21:05	21:22	74-30.03N	165-50.01W	365.0	358.7	5.1	356.2	-	064M01	
A04065	1	2004/9/15	12:49	12:53	70-49.98N	165-50.29W	31.4	32.8	5.1	35.7	36.0	065M01	
A04066	1	2004/9/15	13:59	14:02	70-50.07N	166-20.35W	35.7	30.9	5.1	34.4	34.7	066M01	
A04067	1	2004/9/15	15:08	15:12	70-50.15N	166-50.32W	38.5	31.8	4.8	36.2	36.5	067M01	
A04068	1	2004/9/15	16:15	16:20	70-49.97N	167-19.85W	43.0	35.6	4.0	44.9	45.4	068M01	

Table2.2.1-4 CTD Cast Table

STNNBR	CASTNO	Date(UTC)	Time(UTC)		Start Position		Depth	WIRE	HT ABOVE	Max	Max	CTD data	Remarks
		yyyy/mm/dd	Start	End	Latitude	Longitude			BOTTOM				
A04069	1	2004/9/15	17:24	17:29	70-50.01N	167-50.22W	48.3	47.8	4.2	50.0	50.6	069M01	
A04070	1	2004/9/15	18:31	18:35	70-49.88N	168-20.18W	36.5	35.1	3.8	38.7	38.9	070M01	
A04071	1	2004/9/15	19:35	19:39	70-49.85N	168-49.95W	32.2	33.5	1.9	35.0	31.1	071M01	
A04072	1	2004/9/15	20:50	21:01	71-00.15N	168-49.63W	37.5	28.0	1.6	33.3	31.8	072M01	
A04073	1	2004/9/15	23:23	23:33	71-30.07N	168-49.51W	41.5	43.2	1.9	45.2	45.9	073M01	
A04074	1	2004/9/16	1:51	1:59	72-00.08N	168-51.14W	44.2	41.2	4.2	42.6	43.2	074M01	
A04075	1	2004/9/16	4:18	4:27	72-30.19N	168-49.95W	53.8	57.2	3.2	56.1	56.7	075M01	
A04076	1	2004/9/16	6:45	6:58	73-00.10N	168-50.33W	58.1	57.1	4.9	58.5	59.2	076M01	Longitude input error(186→168)
A04077	1	2004/9/16	9:23	9:46	73-29.92N	168-50.21W	117.0	100.4	2.5	101.0	102.1	077M01	
A04078	1	2004/9/16	12:37	13:06	74-00.09N	168-49.81W	183.0	170.5	4.3	170.9	172.0	078M01	
A04079	1	2004/9/16	16:11	16:37	74-19.87N	169-59.56W	185.0	181.0	3.9	181.3	183.0	079M01	
A04080	1	2004/9/17	3:43	4:12	75-59.84N	166-59.56W	298.0	290.5	4.4	289.0	292.1	080M01	
A04081	1	2004/9/17	6:37	7:31	75-44.88N	165-39.51W	520.0	517.7	9.2	512.2	518.3	081M01	
A04082	1	2004/9/17	11:08	12:47	75-29.87N	163-20.38W	1535.0	1530.6	10.1	1527.7	1548.4	082M01	
A04083	1	2004/9/17	18:10	19:02	76-11.03N	165-36.11W	714.0	706.4	5.2	-	-	083M01	
A04084	1	2004/9/17	21:51	22:13	76-34.84N	164-45.48W	536.0	522.5	4.3	521.3	527.5	084M01	Water sampling were done with rolling up a cable.
A04085	1	2004/9/17	1:44	2:32	76-16.78N	164-36.56W	586.0	660.6	10.9	642.3	650.1	085M01	
A04086	1	2004/9/18	4:48	5:34	75-59.95N	164-59.48W	465.0	442.6	7.4	442.7	447.8	086M01	
A04087	1	2004/9/18	8:30	9:12	75-39.96N	166-29.74W	318.0	307.4	7.8	307.3	311.0	087M01	
A04088	1	2004/9/18	11:24	11:54	75-40.00N	167-59.67W	203.0	190.5	5.4	191.0	-	088M01	
A04089	1	2004/9/18	15:06	16:07	76-09.01N	167-54.65W	677.0	667.2	6.8	663.6	671.8	089M01	
A04090	1	2004/9/18	17:59	19:28	76-15.03N	168-30.78W	1779.0	1767.1	13.9	1757.4	1783.4	090M01	

Table2.2.1-5 CTD Cast Table

STNNBR	CASTNO	Date(UTC)	Time(UTC)		Start Position		Depth	WIRE OUT	HT ABOVE	Max	Max	CTD data file name	Remarks
		yyyy/mm/dd	Start	End	Latitude	Longitude			BOTTOM	Depth	Pressure		
A04091	1	2004/9/18	21:41	22:26	76-22.01N	169-10.57W	2109.0	2112.5	10.1	2105.8	2138.5	091M01	
A04092	1	2004/9/19	2:19	3:31	76-12.38N	168-10.93W	1282.0	1259.8	14.4	1246.2	1262.7	092M01	
A04093	1	2004/9/19	6:56	7:14	75-55.15N	166-00.06W	362.0	355.4	5.0	355.5	359.6	093M01	
A04094	1	2004/9/19	9:27	9:51	75-55.06N	164-30.16W	500.0	491.2	8.6	490.6	496.6	094M01	
A04095	1	2004/9/19	10:41	11:12	75-55.00N	164-04.91W	802.0	789.3	9.6	788.0	797.7	095M01	
A04096	1	2004/9/19	11:51	12:34	75-54.94N	163-49.79W	1206.0	1191.1	5.7	1190.2	1206.0	096M01	
A04097	1	2004/9/19	13:58	15:07	75-55.13N	162-59.81W	2058.0	2072.7	8.8	2045.9	2077.1	097M01	
A04098	1	2004/9/19	17:00	18:43	75-55.00N	161-39.72W	2111.0	2110.6	6.1	2104.9	2138.3	098M01	
A04099	1	2004/9/19	20:51	22:02	75-54.86N	160-20.33W	2104.0	2092.3	7.0	2087.2	2120.2	099M01	
A04100	1	2004/9/19	23:45	1:01	75-54.94N	159-22.85W	1341.0	1287.4	-	1281.5	1299.1	100M01	
A04101	1	2004/9/20	2:29	2:54	75-48.78N	158-31.00W	596.0	597.0	2.4	594.0	600.0	101M01	
A04102	1	2004/9/20	5:12	5:54	75-25.05N	158-09.55W	1195.0	1190.5	9.6	1183.7	1199.3	102M01	
A04103	1	2004/9/20	7:20	8:56	75-27.93N	159-00.48W	1425.0	1409.1	9.1	1404.1	1424.2	103M01	
A04104	1	2004/9/20	11:41	12:56	75-02.36N	159-09.27W	1207.0	1187.0	12.2	1182.4	1198.1	104M01	There are jellyfish in tube.
A04105	1	2004/9/20	15:00	16:27	74-59.94N	157-49.62W	1350.0	1345.7	10.6	1339.9	1358.7	105M01	
A04106	1	2004/9/20	19:15	20:26	75-30.07N	156-39.75W	1192.0	1186.3	6.6	1183.1	1198.7	106M01	
A04107	1	2004/9/20	23:04	1:12	74-59.99N	155-59.53W	3856.0	3838.7	12.1	3830.2	-	107M01	
A04108	1	2004/9/21	2:21	4:45	75-07.52N	156-29.84W	3565.0	3500.3	28.9	3481.3	3547.9	108M01	
A04109	1	2004/9/21	7:21	8:28	74-44.99N	154-59.86W	3858.0	2011.7	-	2000.7	2031.6	109M01	
A04110	1	2004/9/21	10:22	13:11	74-30.05N	154-00.02W	3856.0	3842.0	-	3832.6	3908.4	110M01	
A04111	1	2004/9/21	15:05	16:13	74-14.83N	153-00.49W	3851.0	2013.5	-	2000.8	2031.9	111M01	There are miss write on Date.9/20→9/21
A04112	1	2004/9/21	18:42	21:20	74-00.42N	151-58.85W	3847.0	3833.4	16.7	3819.6	3894.8	112M01	

Table2.2.1-6 CTD Cast Table

STNNBR	CASTNO	Date(UTC)	Time(UTC)		Start Position		Depth	WIRE OUT	HT ABOVE	Max	Max	CTD data file name	Remarks
		yyyy/mm/dd	Start	End	Latitude	Longitude			BOTTOM	Depth	Pressure		
A04113	1	2004/9/21	23:54	1:04	73-30.15N	151-59.39W	3845.0	1991.0	-	-	2000.0	113M01	
A04114	1	2004/9/22	4:48	7:27	73-00.03N	152-00.08W	3829.0	3823.9	9.9	3810.1	3885.0	114M01	
A04115	1	2004/9/22	10:08	11:20	73-15.14N	153-00.24W	3845.0	2008.9	-	2001.9	2032.9	115M01	
A04116	1	2004/9/22	13:42	16:24	73-30.09N	153-59.91W	3851.0	3847.3	10.4	3834.7	3910.5	116M01	
A04117	1	2004/9/22	18:16	19:22	73-45.10N	155-00.26W	3862.0	2056.4	-	2000.5	2031.9	117M01	
A04118	1	2004/9/22	21:19	23:58	74-00.07N	156-00.04W	3857.0	3845.9	39.9	3804.7	3879.8	118M01	
A04119	1	2004/9/23	2:23	3:38	74-15.11N	157-00.49W	3860.0	2027.3	-	2000.2	-	119M01	
A04120	1	2004/9/23	5:09	7:34	74-26.26N	157-44.82W	3470.0	3430.5	30.0	3419.4	3483.7	120M01	
A04121	1	2004/9/23	9:46	10:24	74-45.11N	158-59.97W	927.0	911.0	12.9	909.3	920.7	121M01	
A04122	1	2004/9/23	12:19	13:26	75-00.04N	159-59.98W	1964.0	1954.5	10.3	1948.4	1978.3	122M01	
A04123	1	2004/9/23	14:51	15:52	75-00.03N	161-00.10W	1737.0	1732.6	14.9	1726.0	1751.3	123M01	
A04124	1	2004/9/23	17:21	18:55	75-00.39N	162-00.14W	1974.0	1998.0	10.2	1961.0	1990.0	124M01	
A04125	1	2004/9/23	20:55	21:53	75-00.09N	163-29.82W	1611.0	1597.6	9.8	1591.0	1613.9	125M01	
A04126	1	2004/9/23	22:30	23:13	74-59.96N	163-45.30W	1198.0	1176.8	14.5	1171.7	1187.7	126M01	Time input error.(21:20→22:20)
A04127	1	2004/9/23	23:52	0:20	75-00.03N	164-00.03W	685.0	681.9	4.6	677.8	686.4	127M01	
A04128	1	2004/9/24	2:16	-	74-37.49N	163-30.07W	1208.0	1206.3	9.6	1201.2	1217.7	128M01	
A04129	1	2004/9/24	5:40	5:59	74-37.59N	165-20.31W	411.0	394.6	8.9	394.4	399.2	129M01	
A04130	1	2004/9/24	7:46	8:34	74-22.56N	164-30.17W	417.0	405.0	9.2	404.0	408.8	130M01	
A04131	1	2004/9/24	10:25	11:01	74-07.51N	165-30.07W	230.0	209.9	8.8	210.5	212.5	131M01	
A04132	1	2004/9/24	13:35	14:14	74-27.57N	167-05.07W	314.0	290.0	8.8	291.3	294.6	132M01	
A04133	1	2004/9/24	15:59	16:10	74-30.02N	168-20.03W	246.0	234.1	6.8	234.2	236.5	133M01	
A04134	1	2004/9/24	17:44	17:55	74-33.60N	169-30.24W	198.0	-	4.6	189.8	191.6	134M01	Water sampling were done with rolling up a cable.

Table2.2.1-7 CTD Cast Table

STNNBR	CASTNO	Date(UTC)	Time(UTC)		Start Position		Depth	WIRE	HT ABOVE	Max	Max	CTD data	Remarks
		yyyy/mm/dd	Start	End	Latitude	Longitude		OUT	BOTTOM	Depth	Pressure		
A04135	1	2004/9/24	19:11	19:21	74-26.36N	168-44.32W	202.0	-	4.8	190.9	192.8	135M01	Water sampling were done with rolling up a cable.
A04136	1	2004/9/24	20:53	21:03	74-09.49N	168-22.42W	194.0	189.5	4.4	189.2	190.9	136M01	
A04137	1	2004/9/24	23:22	23:49	73-58.63N	167-35.04W	197.0	186.5	5.6	188.4	191.8	137M01	
A04138	1	2004/9/25	1:31	1:51	73-45.03N	166-50.28W	155.0	142.3	4.5	144.7	144.5	138M01	
A04139	1	2004/9/25	3:37	3:49	73-30.04N	166-00.18W	83.1	80.8	5.4	81.8	82.6	139M01	
A04140	1	2004/9/25	5:46	6:08	73-42.60N	165-00.12W	146.0	130.6	8.5	130.5	134.0	140M01	
A04141	1	2004/9/25	8:38	9:14	73-55.05N	164-00.30W	239.0	212.5	10.6	213.2	214.8	141M01	
A04142	1	2004/9/25	10:50	11:03	73-50.10N	163-25.35W	232.0	218.0	7.5	218.0	222.5	142M01	
A04143	1	2004/9/25	19:51	20:06	73-12.03N	161-17.75W	345.0	337.3	4.3	338.2	342.1	143M01	
A04144	1	2004/9/25	21:44	22:10	73-20.17N	160-40.62W	629.0	680.2	17.6	670.8	678.9	144M01	
A04145	1	2004/9/25	23:40	23:56	73-12.54N	160-10.56W	407.0	398.6	4.1	397.8	402.9	145M01	
A04146	1	2004/9/26	1:23	2:02	73-04.00N	159-40.12W	327.0	319.7	6.1	317.8	321.6	146M01	
A04147	1	2004/9/26	3:19	3:32	72-57.53N	159-10.33W	307.0	297.9	5.5	298.2	301.4	147M01	
A04148	1	2004/9/26	4:54	5:08	72-50.11N	158-40.29W	323.0	313.1	6.2	310.4	313.3	148M01	
A04149	1	2004/9/26	6:23	6:36	72-42.65N	158-10.10W	276.0	275.9	4.9	272.6	275.3	149M01	
A04150	1	2004/9/26	7:53	8:29	72-35.15N	157-40.56W	249.0	233.9	9.3	232.0	234.2	150M01	
A04151	1	2004/9/26	9:52	10:05	72-26.88N	157-10.67W	314.0	295.1	7.8	293.3	297.4	151M01	
A04152	1	2004/9/26	11:25	11:38	72-18.59N	156-40.39W	297.0	276.2	8.3	276.5	280.0	152M01	
A04153	1	2004/9/26	12:56	13:07	72-10.32N	156-09.98W	252.0	321.0	7.9	233.0	235.3	153M01	
A04154	1	2004/9/26	14:28	15:01	72-.0214N	155-40.13W	196.0	181.7	9.4	183.6	185.1	154M01	
A04155	1	2004/9/26	-	16:24	71-55.32N	155-10.07W	256.0	246.0	4.8	246.8	248.4	155M01	
A04156	1	2004/9/26	17:24	17:35	71-50.18N	154-47.32W	253.0	241.4	4.3	241.7	244.2	156M01	

Table2.2.1-8 CTD Cast Table

STNNBR	CASTNO	Date(UTC)	Time(UTC)		Start Position		Depth	WIRE OUT	HT ABOVE BOTTOM	Max Depth	Max Pressure	CTD data file name	Remarks
		yyyy/mm/dd	Start	End	Latitude	Longitude							
A04157	1	2004/9/26	18:14	18:22	71-47.68N	154-35.48W	157.0	148.0	4.4	148.7	150.3	157M01	
A04158	1	2004/9/26	19:02	19:07	71-44.94N	154-27.54W	88.0	80.4	4.8	82.6	83.7	158M01	
A04159	1	2004/9/26	19:53	19:57	71-41.59N	154-09.84W	43.0	40.4	4.5	41.5	42.0	159M01	
A04160	1	2004/9/26	21:09	21:35	71-51.62N	153-49.93W	221.0	198.9	4.2	199.6	201.7	160M01	
A04161	1	2004/9/26	22:55	23:02	71-37.97N	153-49.74W	41.7	43.7	3.2	45.0	45.5	161M01	
A04162	1	2004/9/27	0:42	1:26	71-48.54N	152-59.82W	557.0	541.9	5.6	540.1	546.4	162M01	
A04163	1	2004/9/27	3:16	4:07	72-00.03N	154-00.17W	680.0	599.8	-	595.0	602.2	163M01	
A04164	1	2004/9/27	6:00	6:52	72-10.01N	155-08.52W	730.0	749.3	12.2	744.2	753.7	164M01	There are miss fire on bottle#9.
A04165	1	2004/9/27	9:02	9:53	72-26.00N	156-13.15W	1368.0	1363.8	10.0	1358.3	1377.2	165M01	
A04166	1	2004/9/27	11:54	13:12	72-42.08N	157-18.28W	1102.0	1039.3	9.2	1035.5	1048.7	166M01	
A04167	1	2004/9/27	15:11	16:06	72-56.45N	158-19.51W	1442.0	1435.1	15.0	1418.4	1438.2	167M01	
A04168	1	2004/9/29	6:13	6:56	71-16.03N	150-00.80W	542.0	522.9	14.9	-	-	168M01	
A04169	1	2004/9/29	13:57	15:08	72-07.35N	151-00.20W	3049.0	2029.8	-	2000.3	2025.2	169M01	
A04170	1	2004/9/29	16:54	18:57	72-14.95N	152-00.39W	2814.0	2874.8	12.6	2792.0	2840.0	170M01	Longitude input error(151→152)
A04171	1	2004/9/29	20:38	21:47	72-22.61N	153-00.29W	2979.0	2018.3	-	-	-	171M01	
A04172	1	2004/9/29	23:34	1:57	72-29.97N	154-00.36W	2837.0	2835.1	10.1	2802.8	2851.6	172M01	Longitude input error(153→154)
A04173	1	2004/9/30	3:53	5:00	72-44.97N	154-59.92W	3105.0	2037.7	-	2002.4	2033.2	173M01	
A04174	1	2004/9/30	6:56	9:06	73-00.08N	155-59.69W	2989.0	2981.3	10.0	2970.7	3022.8	174M01	
A04175	1	2004/9/30	11:07	12:17	73-15.01N	156-59.95W	3147.0	2010.6	-	2000.5	2031.5	175M01	
A04176	1	2004/9/30	14:16	16:27	73-29.91N	158-00.68W	2825.0	2793.1	18.7	2779.3	2827.4	176M01	
A04177	1	2004/9/30	19:34	21:12	73-20.04N	158-39.86W	2035.0	2009.1	16.5	1999.9	2030.5	177M01	
A04178	1	2004/9/30	23:07	0:32	73-05.12N	157-39.70W	2398.0	2411.1	30.1	2357.9	2395.3	178M01	Water sampling were done with rolling up a cable.

Table2.2.1-9 CTD Cast Table

STNNBR	CASTNO	Date(UTC)	Time(UTC)		Start Position		Depth	WIRE	HT ABOVE	Max	Max	CTD data	Remarks
		yyyy/mm/dd	Start	End	Latitude	Longitude		OUT	BOTTOM	Depth	Pressure		
A04179	1	2004/10/1	2:23	4:13	72-49.99N	156-39.87W	2105.0	2087.3	20.4	2065.5	-	179M01	
A04180	1	2004/10/1	6:12	7:19	72-34.91N	155-40.06W	2162.0	2047.2	-	2001.7	2031.3	180M01	
A04181	1	2004/10/1	9:21	11:06	72-20.01N	154-39.97W	2184.0	2166.5	19.8	2158.5	2192.1	181M01	
A04182	1	2004/10/1	12:48	13:52	72-12.45N	153-39.63W	1871.0	1850.3	14.0	1843.0	1870.4	182M01	
A04183	1	2004/10/1	15:38	17:22	72-05.04N	152-40.15W	2336.0	2291.3	8.5	2281.0	2318.0	183M01	Latitude input error(05..00N→05.00N)
A04184	1	2004/10/1	19:16	20:16	71-52.50N	151-49.69W	1661.0	1662.8	9.7	1674.6	1698.1	184M01	
A04185	1	2004/10/1	21:53	23:42	71-45.11N	150-58.99W	2322.0	2330.5	10.5	2307.8	2344.9	185M01	
A04186	1	2004/10/2	1:19	2:50	71-50.06N	150-00.12W	2787.0	2779.7	14.4	2770.3	2817.4	186M01	
A04187	1	2004/10/2	4:26	5:30	71-52.49N	148-59.78W	3106.0	2010.0	-	2000.6	2031.4	187M01	
A04188	1	2004/10/2	7:09	8:49	71-44.91N	147-59.54W	3036.0	3029.1	13.8	3018.6	3071.8	188M01	
A04189	1	2004/10/2	10:37	11:55	71-27.61N	147-59.99W	2305.0	2305.4	14.9	2293.7	2329.9	189M01	
A04190	1	2004/10/2	13:56	15:06	71-37.54N	146-59.94W	3048.0	2010.4	-	2000.8	2031.5	190M01	
A04191	1	2004/10/2	16:52	18:01	71-30.12N	145-59.86W	2998.0	2041.4	-	2001.2	2037.9	191M01	
A04192	1	2004/10/2	19:43	22:02	71-30.02N	144-59.27W	3189.0	3197.8	12.1	3176.1	3233.5	192M01	5*
A04193	1	2004/10/3	1:26	3:09	71-06.72N	144-59.33W	2053.0	2083.3	11.8	2069.8	2101.8	193M01	
A01194	1	2004/10/3	4:45	5:14	70-48.06N	145-00.14W	272.0	261.8	4.4	261.7	264.6	194M01	Date input error(Sep→Oct)
A04195	1	2004/10/3	7:07	8:10	71-02.29N	146-00.11W	1592.0	1631.7	11.1	1602.7	1624.6	195M01	
A04196	1	2004/10/3	9:58	11:09	71-01.96N	147-00.14W	1113.0	1103.7	15.0	1099.6	1113.8	196M01	
A04197	1	2004/10/3	13:02	13:44	71-10.22N	147-59.92W	1074.0	1097.6	13.8	1093.1	1107.6	197M01	
A04198	1	2004/10/3	15:27	16:44	71-17.20N	148-59.79W	1380.0	1383.2	13.3	1373.1	1391.2	198M01	
A04199	1	2004/10/3	18:37	19:41	71-30.10N	149-59.67W	1975.0	1959.6	20.2	1949.3	1978.3	199M01	
A04200	1	2004/10/3	21:45	21:50	71-15.24N	151-00.22W	56.0	46.3	4.2	48.8	49.6	200M01	Date input error(Sep→Oct)

Table2.2.1-10 CTD Cast Table

STNNBR	CASTNO	Date(UTC)	Time(UTC)		Start Position		Depth	WIRE	HT ABOVE	Max	Max	CTD data	Remarks
		yyyy/mm/dd	Start	End	Latitude	Longitude			OUT	BOTTOM	Depth		
A04201	1	2004/10/3	22:49	23:19	71-23.01N	150-59.88W	272.0	260.5	5.1	260.2	262.8	201M01	Date input error(Sep→Oct)
A04202	1	2004/10/4	0:16	1:14	71-32.05N	151-00.15W	1615.0	1609.0	8.2	1593.5	1616.2	202M01	Date input error(Sep→Oct)
A04203	1	2004/10/4	2:51	3:47	71-32.11N	151-50.05W	775.0	807.2	13.7	789.9	799.6	203M01	6*
A04204	1	2004/10/4	4:56	5:09	71-27.03N	152-15.93W	134.0	118.5	12.7	117.3	119.1	204M01	7*
A04205	1	2004/10/4	6:14	6:29	71-22.20N	152-42.43W	103.0	91.6	8.6	92.0	92.8	205M01	
A04206	1	2004/10/4	17:12	17:20	71-29.91N	160-50.09W	51.0	-	5.4	40.6	40.8	206M01	
A04207	1	2004/10/4	20:38	20:49	71-05.97N	159-19.58W	81.0	-	3.7	68.2	69.1	207M01	
A04208	1	2004/10/5	0:04	0:07	71-10.10N	157-59.94W	40.0	20.8	2.0	22.6	22.5	208M01	
A04209	1	2004/10/5	1:07	1:16	71-20.02N	158-00.11W	118.0	109.9	4.5	110.9	112.0	209M01	
A04210	1	2004/10/5	2:15	2:21	71-30.09N	158-00.17W	72.0	63.5	4.4	65.1	66.0	210M01	
A04211	1	2004/10/5	3:33	3:39	71-40.07N	158-00.10W	68.0	51.4	-	52.9	53.8	211M01	
A04212	1	2004/10/5	4:48	4:54	71-50.05N	158-00.09W	65.0	52.7	6.3	53.5	54.2	212M01	
A04213	1	2004/10/5	6:05	6:11	72-00.01N	158-00.27W	68.0	54.0	6.3	55.8	56.5	213M01	
A04214	1	2004/10/5	7:14	7:28	72-00.05N	157-30.03W	84.0	67.4	8.3	68.4	69.0	214M01	
A04215	1	2004/10/5	8:51	8:59	72-10.06N	157-09.81W	120.0	105.1	6.4	107.0	108.3	215M01	
A04216	1	2004/10/5	10:25	10:35	72-20.18N	157-35.09W	147.0	134.6	6.7	135.5	136.8	216M01	
A04217	1	2004/10/5	11:58	12:21	72-30.07N	157-59.76W	139.0	128.4	6.8	129.5	131.4	217M01	
A04218	1	2004/10/5	13:49	13:54	72-36.11N	158-34.36W	127.0	117.2	6.6	118.6	119.5	218M01	
A04219	1	2004/10/5	15:22	15:32	72-42.16N	159-09.19W	133.0	122.5	5.8	123.8	125.2	219M01	
A04220	1	2004/10/5	16:41	16:49	72-50.06N	159-40.09W	136.0	124.4	4.4	124.3	127.1	220M01	
A04221	1	2004/10/5	18:00	18:18	72-57.67N	160-10.19W	139.0	115.9	10.6	118.7	120.2	221M01	
A04222	1	2004/10/5	20:45	21:30	73-12.00N	159-10.34W	1117.0	1090.8	26.4	1083.0	1095.5	222M01	

Table2.2.1-11 CTD Cast Table

STNNBR	CASTNO	Date(UTC)	Time(UTC)		Start Position		Depth	WIRE	HT ABOVE	Max	Max	CTD data	Remarks
		yyyy/mm/dd	Start	End	Latitude	Longitude		OUT	BOTTOM	Depth	Pressure		
A04223	1	2004/10/5	23:29	0:49	73-29.32N	159-20.72W	2291.0	2265.3	12.2	2259.1	2295.7	223M01	
A04224	1	2004/10/6	3:29	5:46	73-55.08N	159-19.58W	3122.0	3128.4	24.3	3092.2	-	224M01	
A04225	1	2004/10/6	10:01	10:51	74-35.00N	160-30.24W	1138.0	1117.6	17.4	1101.3	1115.4	225M01	
A04228	1	2004/10/8	2:56	3:01	68-55.04N	166-49.94W	39.2	39.2	3.8	40.5	40.9	228M01	
A04229	1	2004/10/8	-	-	68-55.10N	167-10.02W	38.7	-	4.9	24.2	24.2	229M01	
A04230	1	2004/10/8	5:12	5:16	68-55.11N	167-35.05W	48.0	38.1	5.1	-	-	230M01	
A04231	1	2004/10/8	6:20	6:26	68-55.15N	168-00.11W	43.4	41.5	5.5	42.9	43.0	231M01	
A04232	1	2004/10/8	7:32	7:36	68-55.15N	168-25.25W	44.7	44.3	4.3	45.5	45.7	232M01	
A04233	1	2004/10/8	8:43	8:54	68-55.11N	168-50.31W	46.4	45.0	4.7	46.8	47.4	233M01	
A04234	1	2004/10/8	13:05	13:12	68-00.04N	168-49.92W	51.0	31.8	5.7	32.6	-	234M01	
A04235	1	2004/10/8	14:38	14:42	67-57.57N	168-14.99W	51.3	33.3	-	34.4	33.5	235M01	
A04236	1	2004/10/8	16:10	16:15	67-55.18N	167-39.85W	48.7	47.6	4.7	48.8	49.7	236M01	
A04237	1	2004/10/8	17:36	17:40	67-52.67N	167-04.95W	48.9	43.4	9.4	45.2	45.4	237M01	
A04238	1	2004/10/8	18:50	19:11	67-50.16N	166-29.97W	45.0	-	4.8	45.3	46.3	238M01	
A04239	1	2004/10/8	20:25	20:30	67-47.73N	165-55.24W	40.2	38.6	4.4	40.2	40.5	239M01	
A04240	1	2004/10/9	2:35	2:41	67-19.99N	165-04.86W	26.7	19.7	4.6	22.7	-	240M01	
A04241	1	2004/10/9	5:03	5:07	67-00.27N	165-59.97W	19.8	17.2	4.2	19.1	-	241M01	
A04242	1	2004/10/9	7:17	7:21	67-00.19N	167-00.06W	33.9	32.9	4.5	35.2	34.8	242M01	
A04243	1	2004/10/9	9:27	9:31	67-00.11N	168-00.02W	28.1	26.2	5.3	28.1	28.5	243M01	
A04244	1	2004/10/9	10:40	10:43	67-00.00N	168-24.72W	28.8	27.3	4.3	30.8	30.1	244M01	

Table2.2.1-12 CTD Cast Table

1*	The bottom depth is added to the header information since Stn.A04006.
2*	Station number input form change since Stn.A04012.
3*	Bottom depth input form change since Stn.A04022.
4*	There are jellyfish in tube. Washed by TRITONX.
5*	Primary oxygen data were deviated about 0.5 μ mol/kg between 1550db from 1850db of down cast.
6*	Primary conductivity and salinity data were deviated,salinity was lower than secondary about 0.075 between 600db from surface of up cast.
7*	Date input error(Sep→Oct),There are jellyfish in tube.

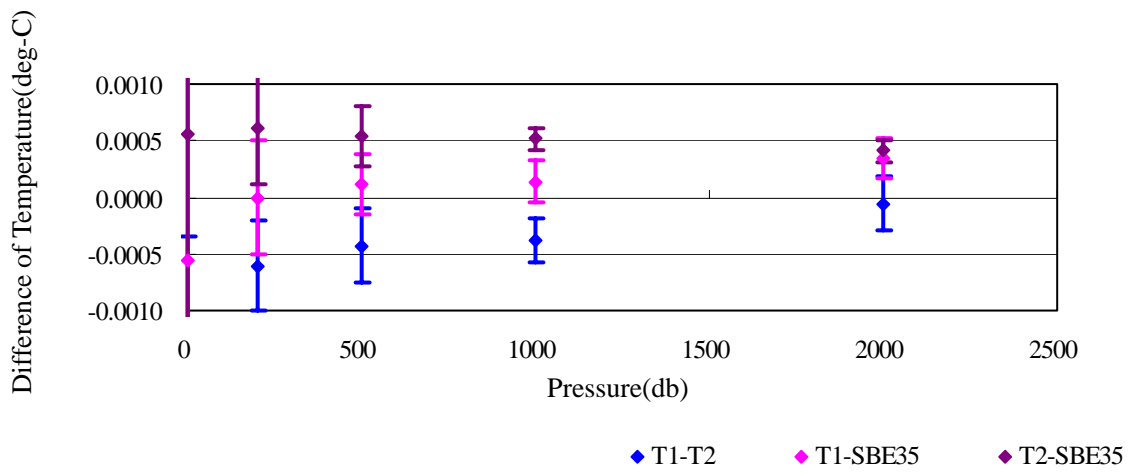

Fig. 2.2.1-1 Pressure dependence of Temperature sensors

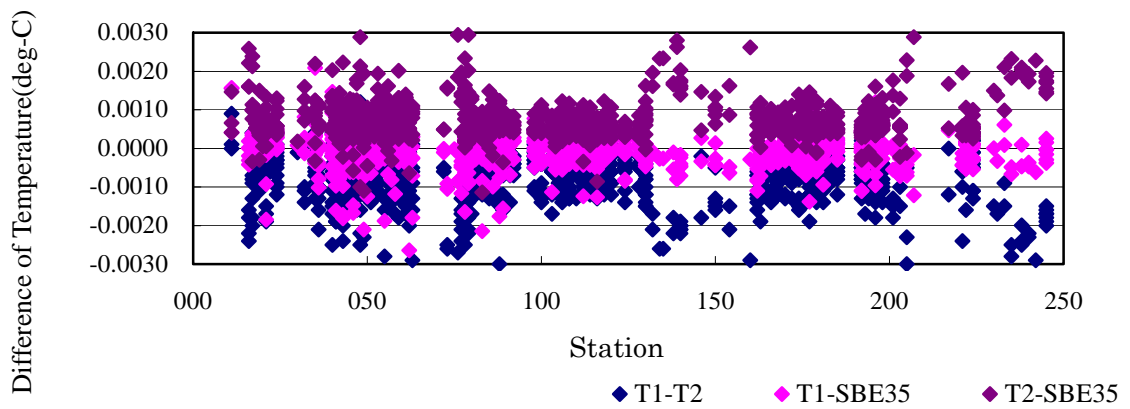

Fig. 2.2.1-2 Time drift of Temperature sensors

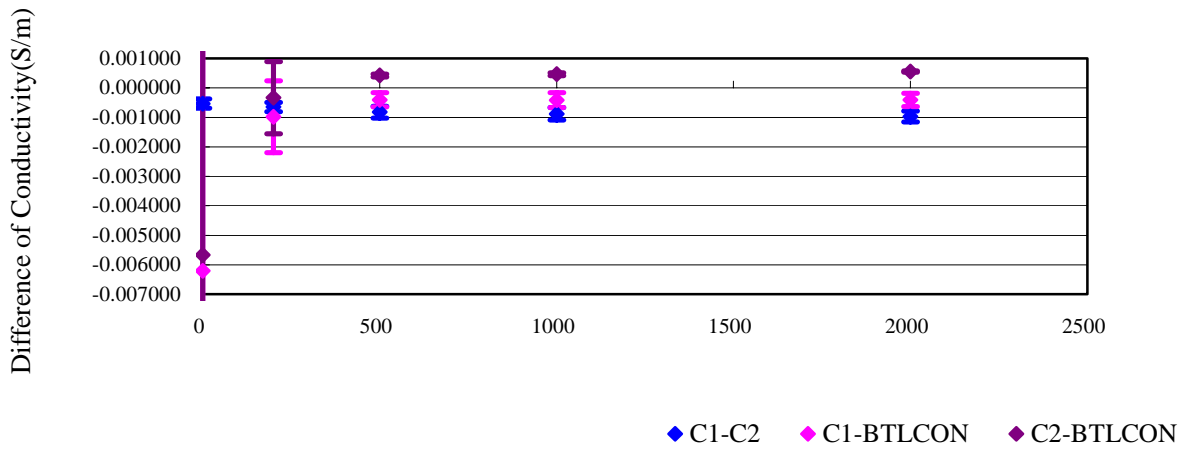

Fig. 2.2.1-3 Pressure dependence of Conductivity

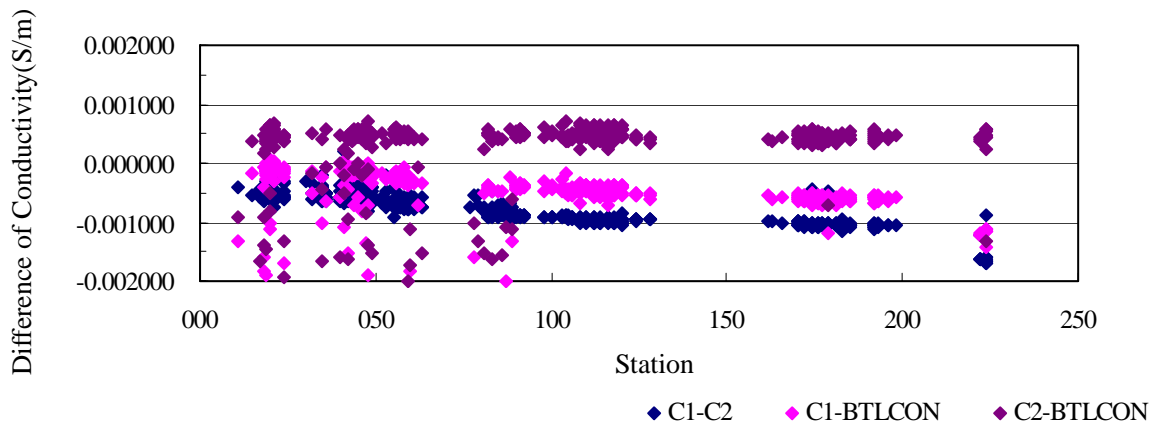

Fig. 2.2.1-4 Time drift of Conductivity

2.2.2. Sample Salinity Measurements

(1) Personnel

Koji Shimada (JAMSTEC) : Principal Investigator
Kenichi Katayama (MWJ) : Operation Leader

(2) Objective

Calibration of salinity measured by CTD

(3) Sampling Elements

Sample water salinity

(4) Instruments and Method

The salinity analysis was carried out on R/V MIRAI during the cruise of MR04-05 using the Guildline AUTOSAL salinometer model 8400B (S/N 62556), with additional peristaltic-type intake pump, manufactured by Ocean Scientific International, Ltd. We also used two Guildline platinum thermometers model 9450. One thermometer monitored an ambient temperature and the other monitored a bath temperature. The resolution of the thermometers was 0.001 deg C. The measurement system was almost same as Aoyama *et al.* (2003).

The salinometer was operated in the air-conditioned ship's laboratory 'AUTOSAL ROOM' at a bath temperature of 24 deg C. An ambient temperature varied from approximately 21 deg C to 23 deg C, while a bath temperature is very stable and varied within +/- 0.002 deg C on rare occasion.

The measurement for each sample was done with a double conductivity ratio that is defined as median of 31 times reading of the salinometer. Data collection is started after 5 seconds and it takes about 10 seconds to collect 31 readings by a personal computer. If the difference between the double conductivity ratio measured for each sample is smaller than 0.00002, the average value of these double conductivity ratio was used to calculate the bottle salinity with the algorithm for practical salinity scale, 1978 (UNESCO, 1981). If this condition isn't satisfied within 5 times in a series of measurement for each sample, we will consider the sample as a bad sample.

(4-1) Salinity Sample Collection

Seawater samples were collected with 12 liter Niskin-X (Non-coating) bottles. The salinity sample bottle of the 250ml brown glass bottle with screw cap was used to collect the sample water. Each bottle and cap was rinsed three times with the sample water, and was filled with sample water to the bottle shoulder. The bottle was stored more than 24 hours in 'AUTOSAL ROOM' before the salinity measurement. Table 2.2.2-1 shows the kind and number of samples.

Table 2.2.2-1: Kind and number of samples

Kind of samples	Number of samples
Samples for CTD	884
Samples for EPCS	36
Total	920

(4-2) Standardization

The salinometer was standardized at the beginning of the sequence of measurements using IAPSO Standard Seawater (SSW) Batch P144 (conductivity ratio; 0.99987, salinity; 34.995). Because of the good stability of the salinometer, standardize of the salinometer was performed only twice: The value of the Standardize Dial was adjusted at the time. 60 bottles of SSW were measured in total (one bad bottle was included), and the average of the double conductivity ratio was 1.99973 and the standard deviation was 0.000023, which is equivalent to 0.0004 in salinity. The value is used for the calibration (linear compensation) of the measured salinity.

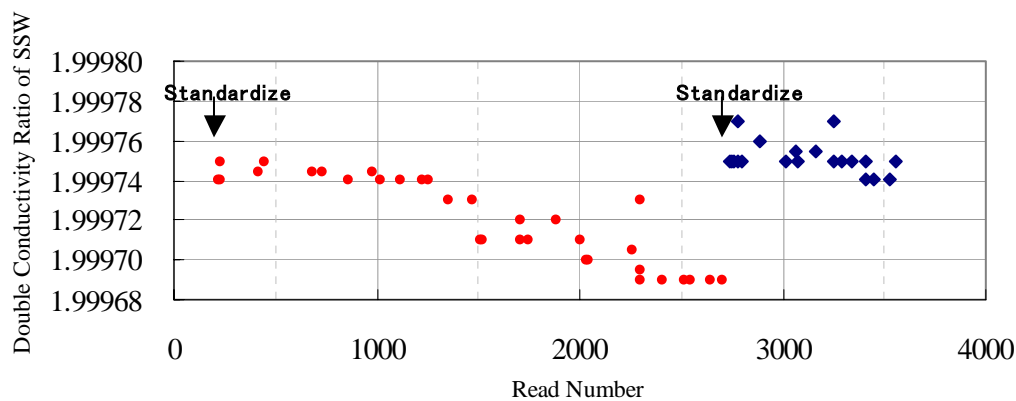

Fig. 2.2.2-1 : The history of double conductivity ratio of SSW (P144)

(4-3) Sub-Standard Seawater

We also used sub-standard seawater which was obtained from 3,000-m depth in MR03-K01 cruise and MR03-K04 Leg1 cruise filtered by Millipore filter (pore size of 0.45 μ m), which was stored in a 20 liter polyethylene container. It was measured every about 6 samples in order to check the drift of the salinometer. During the whole measurements, there was no detectable sudden drift of the salinometer.

(5) Preliminary Results

We estimated the precision of this method using 218 pairs of replicate samples taken from the same Niskin bottle. Fig.2.2.2-2 shows the histogram of absolute difference between replicate samples. There were 2 bad and 23 questionable measurements in replicate samples. These might be the cause of insufficient seal of the sample bottles or mistake in sampling. Excluding shallow pairs ($< 1,000$ db) and these questionable measurements, the average and the standard deviation of absolute difference among 191 pairs of replicate samples were 0.0001 (M) and 0.0001 (σ), respectively. According to 3σ method ($M + 3\sigma$), the precision of this measurement would be less than 0.001 in salinity.

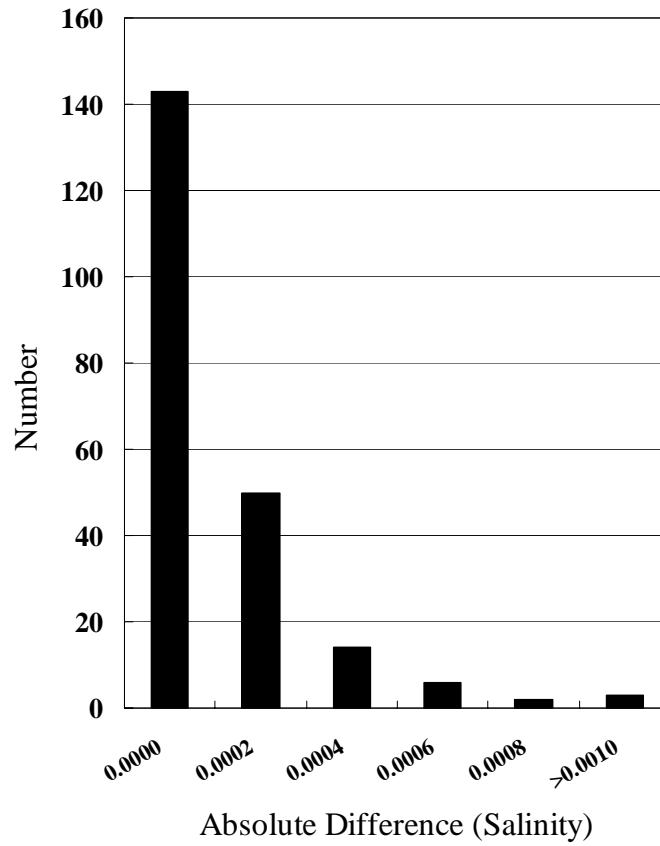

Fig. 2.2.2-2 : The histogram of absolute difference between replicate samples

(6) Data Archives

All processed salinity data were submitted to Principal Investigator according to the data management policy of JAMSTEC.

(7) Reference

- Aoyama, M., T. Joyce, T. Kawano and Y. Takatsuki : Standard seawater comparison up to P129. *Deep-Sea Research*, I, Vol. 49, 1103~1114, 2002
- UNESCO : Tenth report of the Joint Panel on Oceanographic Tables and Standards. *UNESCO Technical Papers in Marine Science*, 36, 25 pp., 1981

2.2.3. Shipboard ADCP Observation

(1) Personnel

Koji SHIMADA (JAMSTEC) Principal investigator
Souichiro SUEYOSHI (Global Ocean Development Inc. GODI)
Shinya OKUMURA (GODI)
Katsuhisa MAENO (GODI)
Kazuho YOSHIDA (GODI)

(2) Objective

To investigate upper ocean circulation and water mass pathway.
To investigate synoptic circulation of ocean in the vicinity of submarine canyons.

(3) Methods

Upper ocean current measurements were made throughout MR04-05 cruise from Dutch Harbor, USA on 01 September 2004 to Dutch Harbor, USA on 12 October 2004 using hull-mounted Acoustic Doppler Current Profiler, *RD Instruments* VM-75 system installed on the centerline and approximately 28 m aft from the bow. The firmware version is 5.59 and the data acquisition software is VmDas Ver.1.3. For most of its operation, the instrument was configured for water-tracking mode recording. Bottom-tracking mode, interleaved bottom-ping with water-ping, was made in shallower water region to get the calibration data for evaluating transducer misalignment angle. Raw data was recorded in beam coordinate, and then converted to earth coordinate using ship's heading data from ship's main gyrocompass, *Tokimec* TG-6000. The position fix data from ship's navigation system was also recorded in NMEA0183 format and merged with ensemble data in the VmDas.

The system consists of following components;

- 1) a 75 kHz Broadband (coded-pulse) profiler with 4-beam Doppler sonar operating at 76.8 kHz (VM-75; RD Instruments, USA), mounted with beams pointing 30 degrees
- 2) from the vertical and 45 degrees azimuth from the keel;
- 3) the Ship's main gyro compass (TG-6000; Tokimec, Japan), continuously providing ship's heading measurements to the ADCP;
- 4) a GPS navigation receiver (Leica MX9400) providing position fixes;
- 5) an IBM-compatible personal computer running data acquisition software (VmDas version 1.3 ; RD Instruments, USA).

The transducer depth was 6.5 m. Every ping was recorded as raw ensemble data (.ENR). Also, 60 seconds and 300 seconds averaged data were recorded as short-term average (.STA) and long-term average (.LTA) data, respectively. We changed the major parameters (Direct Command: See attached Shipboard ADCP configuration). We showed the date and time that we changed:

09/16 09:10 BB75_mr0405_ws5wn100wb2bpDEF.txt
09/16 17:34 BB75_mr0405_ws8wn63wb2bpDEF.txt
09/16 17:40 BB75_mr0405_ws8wn63wb2wf1200bpDEF.txt
09/20 00:02 BB75_mr0405_ws8wn63wb0wf1200bpDEF.txt
09/20 02:41 BB75_mr0405_ws8wn63wb1wf1200bpDEF.txt
09/20 05:13 BB75_mr0405_ws8wn63wb2wf1200bpDEF.txt
09/20 18:29 BB75_mr0405_ws8wn63wb1wf1200bpDEF.txt
09/24 22:50 BB75_mr0405_ws8wn63wb0wf1200wp01bp01DEF.txt
09/25 01:26 BB75_mr0405_ws8wn63wb1wf1200bpDEF.txt
09/25 03:35 BB75_mr0405_ws8wn63wb0wf1200wp01bp01DEF.txt

09/26 01:56 BB75_mr0405_ws8wn63wb0wf1200bpDEF.txt
09/26 09:20 BB75_mr0405_ws8wn63wb1wf1200wp01bp01DEF.txt
09/27 00:39 BB75_mr0405_ws8wn63wb1wf1200wp01bp01bx9DEF.txt
09/27 07:31 BB75_mr0405_ws8wn63wb1wf1200wp01bp00DEF.txt
10/04 05:29 BB75_mr0405_ws8wn63wb1wf1200wp01bp01bx9DEF.txt
10/07 05:17 BB75_mr0405_ws5wn12bpDEF.txt

(4) Data archives

These data obtained in this cruise will be submitted to the JAMSTEC DMD (Data Management Division), and will be opened to the public via “R/V Mirai Data Web Page” in JAMSTEC home page.

Appendix Shipboard ADCP configuration

09/16 09:10 BB75_mr0405_ws5wn100wb2bpDEF.txt

```
;------/
; Restore factory default settings in the ADCP
cr1
; set the data collection baud rate to 19200 bps,
; no parity, one stop bit, 8 data bits
; NOTE: VmDas sends baud rate change command after all other commands in
; this file, so that it is not made permanent by a CK command.
cb511
; Set for reduced bandwidth profile mode, 20-pings per ensembles,
; 18.5 meter blanking distance, 999 mm/s ambiguity vel
WA255
WB2
WC064
WF1850
WP00020
WM1
WS0500
WN100
WV999
; Enable 5-pings bottom track,
; Set maximum bottom search depth to 700 meters
BA020
BC200
BM4
BP005
BX7000
; output velocity, correlation, echo intensity, percent good
WD11111110
; Two seconds between bottom and water pings
TP000200
; 60 seconds between ensembles
; Since VmDas uses manual pinging, TE is ignored by the ADCP.
; You must set the time between ensemble in the VmDas Communication options
TE00010000
; Set to not calculate speed-of-sound, no depth sensor,
; external synchro heading sensor, use internal
; transducer temperature sensor
EZ0020001
; Output beam data (rotations are done in software)
EX000000
; Set transducer depth to 6.5m
ED00065
EC1450
ES35
ET0000
; save this setup to non-volatile memory in the ADCP
CK
```

09/16 17:34 BB75_mr0405_ws8wn63wb2bpDEF.txt

```
;------/
; Restore factory default settings in the ADCP
cr1
; set the data collection baud rate to 19200 bps,
; no parity, one stop bit, 8 data bits
; NOTE: VmDas sends baud rate change command after all other commands in
; this file, so that it is not made permanent by a CK command.
cb511
; Set for reduced bandwidth profile mode, 20-pings per ensembles,
; 23.5 meter blanking distance, 999 mm/s ambiguity vel
WA255
WB2
WC064
WF2350
WP00020
WM1
WS0800
WN63
WV999
; Enable 5-pings bottom track,
; Set maximum bottom search depth to 700 meters
BA020
BC200
BM4
BP005
BX7000
; output velocity, correlation, echo intensity, percent good
WD11111110
; Two seconds between bottom and water pings
TP000200
; 60 seconds between ensembles
; Since VmDas uses manual pinging, TE is ignored by the ADCP.
; You must set the time between ensemble in the VmDas Communication options
TE00010000
; Set to not calculate speed-of-sound, no depth sensor,
; external synchro heading sensor, use internal
; transducer temperature sensor
EZ0020001
; Output beam data (rotations are done in software)
EX00000
; Set transducer depth to 6.5m
ED00065
EC1450
ES35
ET0000
; save this setup to non-volatile memory in the ADCP
CK
```

09/16 17:40 BB75_mr0405_ws8wn63wb2wf1200bpDEF.txt

```
;------/
; Restore factory default settings in the ADCP
cr1
; set the data collection baud rate to 19200 bps,
; no parity, one stop bit, 8 data bits
; NOTE: VmDas sends baud rate change command after all other commands in
; this file, so that it is not made permanent by a CK command.
cb511
; Set for reduced bandwidth profile mode, 20-pings per ensembles,
; 12.0 meter blanking distance, 999 mm/s ambiguity vel
WA255
WB2
WC064
WF1200
WP00020
WM1
WS0800
WN63
WV999
; Enable 5-pings bottom track,
; Set maximum bottom search depth to 700 meters
BA020
BC200
BM4
BP005
BX7000
; output velocity, correlation, echo intensity, percent good
WD11111110
; Two seconds between bottom and water pings
TP000200
; 60 seconds between ensembles
; Since VmDas uses manual pinging, TE is ignored by the ADCP.
; You must set the time between ensemble in the VmDas Communication options
TE00010000
; Set to not calculate speed-of-sound, no depth sensor,
; external synchro heading sensor, use internal
; transducer temperature sensor
EZ0020001
; Output beam data (rotations are done in software)
EX00000
; Set transducer depth to 6.5m
ED00065
EC1450
ES35
ET0000
; save this setup to non-volatile memory in the ADCP
CK
```

09/20 00:02 BB75_mr0405_ws8wn63wb0wf1200bpDEF.txt

```
;------/
; Restore factory default settings in the ADCP
cr1
; set the data collection baud rate to 19200 bps,
; no parity, one stop bit, 8 data bits
; NOTE: VmDas sends baud rate change command after all other commands in
; this file, so that it is not made permanent by a CK command.
cb511
; Set for reduced bandwidth profile mode, 20-pings per ensembles,
; 12.0 meter blanking distance, 999 mm/s ambiguity vel
WA255
WB0
WC064
WF1200
WP00020
WM1
WS0800
WN63
WV999
; Enable 5-pings bottom track,
; Set maximum bottom search depth to 700 meters
BA020
BC200
BM4
BP005
BX7000
; output velocity, correlation, echo intensity, percent good
WD11111110
; Two seconds between bottom and water pings
TP000200
; 60 seconds between ensembles
; Since VmDas uses manual pinging, TE is ignored by the ADCP.
; You must set the time between ensemble in the VmDas Communication options
TE00010000
; Set to not calculate speed-of-sound, no depth sensor,
; external synchro heading sensor, use internal
; transducer temperature sensor
EZ0020001
; Output beam data (rotations are done in software)
EX00000
; Set transducer depth to 6.5m
ED00065
EC1450
ES35
ET0000
; save this setup to non-volatile memory in the ADCP
CK
```

09/20 02:41 BB75_mr0405_ws8wn63wb1wf1200bpDEF.txt

```
;------/
; Restore factory default settings in the ADCP
cr1
; set the data collection baud rate to 19200 bps,
; no parity, one stop bit, 8 data bits
; NOTE: VmDas sends baud rate change command after all other commands in
; this file, so that it is not made permanent by a CK command.
cb511
; Set for reduced bandwidth profile mode, 20-pings per ensembles,
; 12.0 meter blanking distance, 999 mm/s ambiguity vel
WA255
WB1
WC064
WF1200
WP00020
WM1
WS0800
WN63
WV999
; Enable 5-pings bottom track,
; Set maximum bottom search depth to 700 meters
BA020
BC200
BM4
BP005
BX7000
; output velocity, correlation, echo intensity, percent good
WD11111110
; Two seconds between bottom and water pings
TP000200
; 60 seconds between ensembles
; Since VmDas uses manual pinging, TE is ignored by the ADCP.
; You must set the time between ensemble in the VmDas Communication options
TE00010000
; Set to not calculate speed-of-sound, no depth sensor,
; external synchro heading sensor, use internal
; transducer temperature sensor
EZ0020001
; Output beam data (rotations are done in software)
EX00000
; Set transducer depth to 6.5m
ED00065
EC1450
ES35
ET0000
; save this setup to non-volatile memory in the ADCP
CK
```

09/20 05:13 BB75_mr0405_ws8wn63wb2wf1200bpDEF.txt

```
;------/
; Restore factory default settings in the ADCP
cr1
; set the data collection baud rate to 19200 bps,
; no parity, one stop bit, 8 data bits
; NOTE: VmDas sends baud rate change command after all other commands in
; this file, so that it is not made permanent by a CK command.
cb511
; Set for reduced bandwidth profile mode, 20-pings per ensembles,
; 12.0 meter blanking distance, 999 mm/s ambiguity vel
WA255
WB2
WC064
WF1200
WP00020
WM1
WS0800
WN63
WV999
; Enable 5-pings bottom track,
; Set maximum bottom search depth to 700 meters
BA020
BC200
BM4
BP005
BX7000
; output velocity, correlation, echo intensity, percent good
WD11111110
; Two seconds between bottom and water pings
TP000200
; 60 seconds between ensembles
; Since VmDas uses manual pinging, TE is ignored by the ADCP.
; You must set the time between ensemble in the VmDas Communication options
TE00010000
; Set to not calculate speed-of-sound, no depth sensor,
; external synchro heading sensor, use internal
; transducer temperature sensor
EZ0020001
; Output beam data (rotations are done in software)
EX00000
; Set transducer depth to 6.5m
ED00065
EC1450
ES35
ET0000
; save this setup to non-volatile memory in the ADCP
CK
```

09/20 18:29 BB75_mr0405_ws8wn63wb1wf1200bpDEF.txt

```
;------/
; Restore factory default settings in the ADCP
cr1
; set the data collection baud rate to 19200 bps,
; no parity, one stop bit, 8 data bits
; NOTE: VmDas sends baud rate change command after all other commands in
; this file, so that it is not made permanent by a CK command.
cb511
; Set for reduced bandwidth profile mode, 20-pings per ensembles,
; 12.0 meter blanking distance, 999 mm/s ambiguity vel
WA255
WB1
WC064
WF1200
WP00020
WM1
WS0800
WN63
WV999
; Enable 5-pings bottom track,
; Set maximum bottom search depth to 700 meters
BA020
BC200
BM4
BP005
BX7000
; output velocity, correlation, echo intensity, percent good
WD11111110
; Two seconds between bottom and water pings
TP000200
; 60 seconds between ensembles
; Since VmDas uses manual pinging, TE is ignored by the ADCP.
; You must set the time between ensemble in the VmDas Communication options
TE00010000
; Set to not calculate speed-of-sound, no depth sensor,
; external synchro heading sensor, use internal
; transducer temperature sensor
EZ0020001
; Output beam data (rotations are done in software)
EX00000
; Set transducer depth to 6.5m
ED00065
EC1450
ES35
ET0000
; save this setup to non-volatile memory in the ADCP
CK
```

09/24 22:50 BB75_mr0405_ws8wn63wb0wf1200wp01bp01DEF.txt

```
;------/
; Restore factory default settings in the ADCP
cr1
; set the data collection baud rate to 19200 bps,
; no parity, one stop bit, 8 data bits
; NOTE: VmDas sends baud rate change command after all other commands in
; this file, so that it is not made permanent by a CK command.
cb511
; Set for reduced bandwidth profile mode, -pings per ensembles,
; 12 meter blanking distance, 999 mm/s ambiguity vel
WA255
WB0
WC064
WF1200
WP00001
WM1
WS0800
WN63
WV999
; Enable 5-pings bottom track,
; Set maximum bottom search depth to 700 meters
BA020
BC200
BM4
BP001
BX7000
; output velocity, correlation, echo intensity, percent good
WD11111110
; Two seconds between bottom and water pings
TP000200
; 60 seconds between ensembles
; Since VmDas uses manual pinging, TE is ignored by the ADCP.
; You must set the time between ensemble in the VmDas Communication options
TE00010000
; Set to not calculate speed-of-sound, no depth sensor,
; external synchro heading sensor, use internal
; transducer temperature sensor
EZ0020001
; Output beam data (rotations are done in software)
EX00000
; Set transducer depth to 6.5m
ED00065
EC1450
ES35
ET0000
; save this setup to non-volatile memory in the ADCP
CK
```

09/25 01:26 BB75_mr0405_ws8wn63wb1wf1200bpDEF.txt

```
;------/
; Restore factory default settings in the ADCP
cr1
; set the data collection baud rate to 19200 bps,
; no parity, one stop bit, 8 data bits
; NOTE: VmDas sends baud rate change command after all other commands in
; this file, so that it is not made permanent by a CK command.
cb511
; Set for reduced bandwidth profile mode, 20-pings per ensembles,
; 12.0 meter blanking distance, 999 mm/s ambiguity vel
WA255
WB1
WC064
WF1200
WP00020
WM1
WS0800
WN63
WV999
; Enable 5-pings bottom track,
; Set maximum bottom search depth to 700 meters
BA020
BC200
BM4
BP005
BX7000
; output velocity, correlation, echo intensity, percent good
WD11111110
; Two seconds between bottom and water pings
TP000200
; 60 seconds between ensembles
; Since VmDas uses manual pinging, TE is ignored by the ADCP.
; You must set the time between ensemble in the VmDas Communication options
TE00010000
; Set to not calculate speed-of-sound, no depth sensor,
; external synchro heading sensor, use internal
; transducer temperature sensor
EZ0020001
; Output beam data (rotations are done in software)
EX00000
; Set transducer depth to 6.5m
ED00065
EC1450
ES35
ET0000
; save this setup to non-volatile memory in the ADCP
CK
```

09/25 03:35 BB75_mr0405_ws8wn63wb0wf1200wp01bp01DEF.txt

```
;------/
; Restore factory default settings in the ADCP
cr1
; set the data collection baud rate to 19200 bps,
; no parity, one stop bit, 8 data bits
; NOTE: VmDas sends baud rate change command after all other commands in
; this file, so that it is not made permanent by a CK command.
cb511
; Set for reduced bandwidth profile mode, -pings per ensembles,
; 12 meter blanking distance, 999 mm/s ambiguity vel
WA255
WB0
WC064
WF1200
WP00001
WM1
WS0800
WN63
WV999
; Enable 5-pings bottom track,
; Set maximum bottom search depth to 700 meters
BA020
BC200
BM4
BP001
BX7000
; output velocity, correlation, echo intensity, percent good
WD11111110
; Two seconds between bottom and water pings
TP000200
; 60 seconds between ensembles
; Since VmDas uses manual pinging, TE is ignored by the ADCP.
; You must set the time between ensemble in the VmDas Communication options
TE00010000
; Set to not calculate speed-of-sound, no depth sensor,
; external synchro heading sensor, use internal
; transducer temperature sensor
EZ0020001
; Output beam data (rotations are done in software)
EX00000
; Set transducer depth to 6.5m
ED00065
EC1450
ES35
ET0000
; save this setup to non-volatile memory in the ADCP
CK
```

09/26 01:56 BB75_mr0405_ws8wn63wb0wf1200bpDEF.txt

```
;------/
; Restore factory default settings in the ADCP
cr1
; set the data collection baud rate to 19200 bps,
; no parity, one stop bit, 8 data bits
; NOTE: VmDas sends baud rate change command after all other commands in
; this file, so that it is not made permanent by a CK command.
cb511
; Set for reduced bandwidth profile mode, 20-pings per ensembles,
; (with meter bin) , 12.0 meter blanking distance, 999 mm/s ambiguity vel
WA255
WB0
WC064
WF1200
WP00020
WM1
WS0800
WN63
WV999
; Enable 5-pings bottom track,
; Set maximum bottom search depth to 700 meters
BA020
BC200
BM4
BP005
BX7000
; output velocity, correlation, echo intensity, percent good
WD11111110
; Two seconds between bottom and water pings
TP000200
; 60 seconds between ensembles
; Since VmDas uses manual pinging, TE is ignored by the ADCP.
; You must set the time between ensemble in the VmDas Communication options
TE00010000
; Set to not calculate speed-of-sound, no depth sensor,
; external synchro heading sensor, use internal
; transducer temperature sensor
EZ0020001
; Output beam data (rotations are done in software)
EX00000
; Set transducer depth to 6.5m
ED00065
EC1450
ES35
ET0000
; save this setup to non-volatile memory in the ADCP
CK
```

09/26 09:20 BBB75_mr0405_ws8wn63wb1wf1200wp01bp01DEF.txt

```
;------/
; Restore factory default settings in the ADCP
cr1
; set the data collection baud rate to 19200 bps,
; no parity, one stop bit, 8 data bits
; NOTE: VmDas sends baud rate change command after all other commands in
; this file, so that it is not made permanent by a CK command.
cb511
; Set for reduced bandwidth profile mode, -pings per ensembles,
; (with meter bin) , 18.5 meter blanking distance, 999 mm/s ambiguity vel
WA255
WB1
WC064
WF1200
WP00001
WM1
WS0800
WN63
WV999
; Enable 5-pings bottom track,
; Set maximum bottom search depth to 700 meters
BA020
BC200
BM4
BP001
BX7000
; output velocity, correlation, echo intensity, percent good
WD11111110
; Two seconds between bottom and water pings
TP000200
; 60 seconds between ensembles
; Since VmDas uses manual pinging, TE is ignored by the ADCP.
; You must set the time between ensemble in the VmDas Communication options
TE00010000
; Set to not calculate speed-of-sound, no depth sensor,
; external synchro heading sensor, use internal
; transducer temperature sensor
EZ0020001
; Output beam data (rotations are done in software)
EX00000
; Set transducer depth to 6.5m
ED00065
EC1450
ES35
ET0000
; save this setup to non-volatile memory in the ADCP
CK
```

09/27 00:39 BB75_mr0405_ws8wn63wb1wf1200wp01bp01bx9DEF.txt

```
;------/
; Restore factory default settings in the ADCP
cr1
; set the data collection baud rate to 19200 bps,
; no parity, one stop bit, 8 data bits
; NOTE: VmDas sends baud rate change command after all other commands in
; this file, so that it is not made permanent by a CK command.
cb511
; Set for reduced bandwidth profile mode, -pings per ensembles,
; 12.0meter blanking distance, 999 mm/s ambiguity vel
WA255
WB1
WC064
WF1200
WP00001
WM1
WS0800
WN63
WV999
; Enable 5-pings bottom track,
; Set maximum bottom search depth to 999 meters
BA020
BC200
BM4
BP001
BX9999
; output velocity, correlation, echo intensity, percent good
WD11111110
; Two seconds between bottom and water pings
TP000200
; 60 seconds between ensembles
; Since VmDas uses manual pinging, TE is ignored by the ADCP.
; You must set the time between ensemble in the VmDas Communication options
TE00010000
; Set to not calculate speed-of-sound, no depth sensor,
; external synchro heading sensor, use internal
; transducer temperature sensor
EZ0020001
; Output beam data (rotations are done in software)
EX00000
; Set transducer depth to 6.5m
ED00065
EC1450
ES35
ET0000
; save this setup to non-volatile memory in the ADCP
CK
```

09/27 07:31 BB75_mr0405_ws8wn63wb1wf1200wp01bp00DEF.txt

```
;------/
; Restore factory default settings in the ADCP
cr1
; set the data collection baud rate to 19200 bps,
; no parity, one stop bit, 8 data bits
; NOTE: VmDas sends baud rate change command after all other commands in
; this file, so that it is not made permanent by a CK command.
cb511
; Set for reduced bandwidth profile mode, -pings per ensembles,
; 12.0meter blanking distance, 999 mm/s ambiguity vel
WA255
WB1
WC064
WF1200
WP00001
WM1
WS0800
WN63
WV999
; Enable 5-pings bottom track,
; Set maximum bottom search depth to 999 meters
BA020
BC200
BM4
BP000
BX9999
; output velocity, correlation, echo intensity, percent good
WD11111110
; Two seconds between bottom and water pings
TP000200
; 60 seconds between ensembles
; Since VmDas uses manual pinging, TE is ignored by the ADCP.
; You must set the time between ensemble in the VmDas Communication options
TE00010000
; Set to not calculate speed-of-sound, no depth sensor,
; external synchro heading sensor, use internal
; transducer temperature sensor
EZ0020001
; Output beam data (rotations are done in software)
EX00000
; Set transducer depth to 6.5m
ED00065
EC1450
ES35
ET0000
; save this setup to non-volatile memory in the ADCP
CK
```

10/04 05:29 BB75_mr0405_ws8wn63wb1wf1200wp01bp01bx9DEF.txt

```
;------/
; Restore factory default settings in the ADCP
cr1
; set the data collection baud rate to 19200 bps,
; no parity, one stop bit, 8 data bits
; NOTE: VmDas sends baud rate change command after all other commands in
; this file, so that it is not made permanent by a CK command.
cb511
; Set for reduced bandwidth profile mode, -pings per ensembles,
; 12.0meter blanking distance, 999 mm/s ambiguity vel
WA255
WB1
WC064
WF1200
WP00001
WM1
WS0800
WN63
WV999
; Enable 5-pings bottom track,
; Set maximum bottom search depth to 999 meters
BA020
BC200
BM4
BP001
BX9999
; output velocity, correlation, echo intensity, percent good
WD11111110
; Two seconds between bottom and water pings
TP000200
; 60 seconds between ensembles
; Since VmDas uses manual pinging, TE is ignored by the ADCP.
; You must set the time between ensemble in the VmDas Communication options
TE00010000
; Set to not calculate speed-of-sound, no depth sensor,
; external synchro heading sensor, use internal
; transducer temperature sensor
EZ0020001
; Output beam data (rotations are done in software)
EX00000
; Set transducer depth to 6.5m
ED00065
EC1450
ES35
ET0000
; save this setup to non-volatile memory in the ADCP
CK
```

10/07 05:17 BB75_mr0405_ws5wn12bpDEF.txt

```
;------/
; Restore factory default settings in the ADCP
cr1
; set the data collection baud rate to 19200 bps,
; no parity, one stop bit, 8 data bits
; NOTE: VmDas sends baud rate change command after all other commands in
; this file, so that it is not made permanent by a CK command.
cb511
; Set for reduced bandwidth profile mode, 01-pings per ensembles,
; 12.0meter blanking distance, 999 mm/s ambiguity vel
WA255
WB1
WC064
WF1200
WP00001
WM1
WS0500
WN12
WV999
;
; Set maximum bottom search depth to 070 meters
BA020
BC200
BM4
BP001
BX0700
; output velocity, correlation, echo intensity, percent good
WD11111110
; Two seconds between bottom and water pings
TP000200
; 60 seconds between ensembles
; Since VmDas uses manual pinging, TE is ignored by the ADCP.
; You must set the time between ensemble in the VmDas Communication options
TE00010000
; Set to not calculate speed-of-sound, no depth sensor,
; external synchro heading sensor, use internal
; transducer temperature sensor
EZ0020001
; Output beam data (rotations are done in software)
EX00000
; Set transducer depth to 6.5m
ED00065
EC1450
ES35
ET0000
; save this setup to non-volatile memory in the ADCP
CK
```

2.2.4. XCTD observations

(1) Personnel

Koji SHIMADA (JAMSTEC) Principal Investigator
 Souichirou SUEYOSHI (GODI)
 Shinya OKUMURA (GODI)
 Katushisa MAENO (GODI)
 Kazuho YOSHIDA (GODI)

(2) Objective

To investigate the oceanic structure and its time variability, vertical profiles of temperature and salinity or temperature were observed by XCTD systems.

(3) Parameters

According to the manufacturer's nominal specifications, the range and accuracy of parameters measured by the XCTD (eXpendable Conductivity, Temperature & Depth profiler) are as follows;

Parameter	Range	Accuracy
Conductivity	0 ~ 60 [mS/cm]	+/- 0.03 [mS/cm]
Temperature	-2 ~ 35 [deg-C]	+/- 0.02 [deg-C]
Depth	0 ~ 1000 [m]	5 [m] or 2 [%] (either of them is major)

(4) Methods

We observed the vertical profiles of the sea water temperature and salinity measured by XCTD-1 manufactured by Tsurumi-Seiki Co.. The signal was converted by digital converter (MK-100, Tsurumi-Seiki Co.) and was recorded by WinXCTD software (Ver.1.07, Tsurumi-Seiki Co.). We cast 115 probes by hand and automatic launcher.

(5) Observation log

Table 2.2.4-1 XCTD observation log

Station	Date	Time	Latitude	Lonitude	SST	SSS	MD	WD	S/N
X001	2004 /09 /07	02:42:27	73-33.4635 N	160-29.7790 W	2.339	26.704	1100	1699	4068633
X002	2004 /09 /07	16:18:50	74-10.2029 N	157-27.2087 W	0.337	26.247	1100	3863	4068634
X003	2004 /09 /07	17:08:40	74-20.0549 N	157-22.2294 W	0.585	26.223	1100	3856	4068635
X004	2004 /09 /07	20:43:02	74-26.5850 N	157-34.5762 W	0.398	26.391	1100	3852	4068636
X005	2004 /09 /08	05:11:35	74-35.5557 N	158-46.3649 W	0.950	26.364	876	0917	4068638
X006	2004 /09 /08	05:46:22	74-38.6794 N	159-09.9719 W	1.136	26.509	1100	1695	4068639
X007	2004 /09 /08	06:15:30	74-41.1519 N	159-30.0038 W	1.206	26.577	1100	1747	4068640
X008	2004 /09 /08	07:07:05	74-44.9331 N	159-59.5960 W	0.430	26.542	1100	1612	4068641
X009	2004 /09 /08	08:10:42	74-31.9139 N	159-59.8002 W	1.338	26.570	612	0603	4068643
X010	2004 /09 /08	09:09:53	74-19.9337 N	159-59.7386 W	0.991	26.579	526	0555	4068642
X011	2004 /09 /08	10:47:33	74-00.0287 N	160-00.0502 W	1.080	26.258	967	1040	4058538
X012	2004 /09 /08	11:11:52	73-55.0397 N	160-00.0078 W	2.301	26.663	1100	2248	4058537
X013	2004 /09 /08	11:50:25	73-50.0323 N	159-59.9183 W	2.392	26.660	1100	2700	4058536
X014	2004 /09 /08	13:02:26	73-59.9651 N	160-39.3209 W	1.928	26.531	600	0598	4058541
X015	2004 /09 /08	13:53:49	74-07.4854 N	161-07.6132 W	0.876	26.298	565	0580	4058540
X016	2004 /09 /08	14:44:52	74-15.0019 N	161-34.9791 W	1.126	26.390	1087	1448	4058539
X017	2004 /09 /10	23:33:10	76-02.4552 N	174-00.6109 W	-0.672	28.940	1100	2149	4058544
X018	2004 /09 /11	04:14:56	76-05.6272 N	174-40.4001 W	-0.401	28.815	1100	2186	4058542
X019	2004 /09 /11	08:11:31	75-56.2066 N	175-59.9201 W	-0.506	28.906	1100	1968	4058543
X020	2004 /09 /11	08:48:16	75-55.9270 N	176-30.0229 W	-0.744	29.023	1100	1866	4058546
X021	2004 /09 /11	09:12:34	75-56.0263 N	176-50.0270 W	-0.746	29.015	1100	1430	4058545

Table 2.2.4-1 XCTD observation log (continue)

Station	Date	Time	Latitude	Longitude	SST	SSS	MD	WD	S/N
X022	2004 /09 /11	10:09:11	75-47.8011 N	176-50.0064 W	-0.581	28.925	1100	1338	4058547
X023	2004 /09 /11	12:59:56	75-43.8717 N	176-50.0561 W	-0.641	28.972	1100	1355	4068622
X024	2004 /09 /11	13:37:06	75-43.9541 N	177-20.0514 W	-0.673	29.015	1100	1217	4068625
X025	2004 /09 /11	17:56:21	75-39.5625 N	176-50.0296 W	-0.526	28.903	1100	1399	4068631
X026	2004 /09 /11	19:00:42	75-31.2547 N	177-30.0426 W	-0.244	28.500	1100	1142	4068628
X027	2004 /09 /11	22:31:43	75-19.9473 N	177-59.9898 W	-0.478	27.372	898	0900	4068620
X028	2004 /09 /11	22:57:06	75-14.9939 N	178-03.1339 W	-0.426	27.583	749	0750	4068621
X029	2004 /09 /11	23:23:05	75-09.9172 N	178-06.0776 W	-0.524	27.351	544	0546	4068623
X030	2004 /09 /11	23:53:36	75-05.1103 N	178-11.5679 W	-0.776	26.794	514	0523	4068624
X031	2004 /09 /12	03:12:08	75-13.2269 N	178-52.3074 W	-0.582	27.531	604	0604	4068626
X032	2004 /09 /12	14:21:04	75-19.9764 N	179-20.4091 W	-0.365	27.666	760	0765	4068630
X033	2004 /09 /12	17:41:58	75-39.9846 N	178-59.2239 W	-0.428	28.269	1100	1093	4068627
X034	2004 /09 /12	21:48:18	75-54.9743 N	179-11.8315 W	-0.628	26.468	1100	1138	4068629
X035	2004 /09 /12	23:38:05	76-04.8342 N	179-40.6701 W	-0.858	28.762	1100	1170	4058524
X036	2004 /09 /13	02:08:41	76-01.4057 N	178-19.2599 W	-0.486	28.437	1029	1032	4058525
X037	2004 /09 /13	06:16:13	75-46.6448 N	177-25.0072 W	-0.659	28.916	1100	-	4058526
X038	2004 /09 /13	06:36:40	75-48.1967 N	177-09.9971 W	-0.649	28.956	1100	-	4058527
X039	2004 /09 /13	07:00:25	75-51.1017 N	176-54.9742 W	-0.640	28.869	1100	-	4058528
X040	2004 /09 /13	07:30:13	75-55.3280 N	176-40.0239 W	-0.911	28.970	1100	1710	4058529
X041	2004 /09 /13	14:56:48	76-01.8290 N	173-22.4487 W	-1.082	28.822	1100	2083	4058531
X042	2004 /09 /13	18:56:35	75-55.2649 N	172-02.6502 W	-1.035	28.869	1100	1896	4058532
X043	2004 /09 /13	22:36:14	75-43.8973 N	170-52.5192 W	-0.557	28.025	1100	1640	4058530
X044	2004 /09 /14	03:43:04	75-34.9023 N	170-05.0821 W	-0.550	27.246	957	0953	4058533
X045	2004 /09 /14	04:45:46	75-28.5571 N	169-22.6822 W	-0.440	26.996	365	0365	4058534
X046	2004 /09 /17	17:27:32	76-07.4298 N	165-21.3231 W	-0.949	27.524	704	0706	4058585
X047	2004 /09 /17	19:59:57	76-18.6467 N	165-20.1024 W	-1.067	27.535	593	0589	4058584
X048	2004 /09 /17	20:27:49	76-23.6565 N	165-03.1461 W	-1.324	28.126	532	0528	4058588
X049	2004 /09 /18	00:59:54	76-19.0036 N	164-48.7799 W	-0.993	27.442	485	0498	4058587
X050	2004 /09 /18	03:17:56	76-10.0193 N	164-20.1572 W	-1.158	27.319	939	0953	4058589
X051	2004 /09 /18	10:14:52	75-39.8223 N	167-14.9202 W	-0.494	27.156	204	0213	4058590
X052	2004 /09 /18	13:22:44	75-54.9976 N	167-59.9856 W	-0.611	27.789	261	0259	4058591
X053	2004 /09 /19	04:44:20	76-04.5251 N	167-30.1167 W	-0.788	27.915	293	0299	4058592
X054	2004 /09 /19	22:33:29	75-55.0355 N	160-00.0346 W	-1.149	27.091	1100	1770	4058593
X055	2004 /09 /19	23:09:54	75-54.9071 N	159-29.9819 W	-1.325	27.358	1100	1670	4058594
X056	2004 /09 /20	01:35:10	75-52.9219 N	159-00.0519 W	-1.279	27.317	688	0684	4058595
X057	2004 /09 /20	04:03:19	75-36.0000 N	158-19.6489 W	-1.223	27.123	1019	1051	4068619
X058	2004 /09 /20	10:14:58	75-13.9912 N	159-04.4515 W	-0.368	26.577	931	0933	4068616
X059	2004 /09 /20	13:41:18	75-01.6736 N	158-39.8972 W	0.971	26.273	995	1011	4068615
X060	2004 /09 /20	17:31:58	75-11.9761 N	157-20.4074 W	-0.971	26.772	1100	1475	4068618
X061	2004 /09 /20	18:02:20	75-17.9884 N	157-07.1431 W	-1.099	26.850	1100	1528	4068613
X062	2004 /09 /20	20:58:29	75-24.4149 N	156-30.7071 W	-1.160	26.868	1100	1433	4068614
X063	2004 /09 /20	21:19:48	75-20.0145 N	156-25.3551 W	-1.087	26.816	1100	1926	4068612
X064	2004 /09 /20	21:43:19	75-15.0109 N	156-19.9329 W	-1.119	26.835	1100	2272	4068611
X065	2004 /09 /20	22:06:41	75-10.0224 N	156-13.3415 W	-0.623	26.684	1100	3850	4068610
X066	2004 /09 /21	06:21:24	74-52.6066 N	155-29.9900 W	0.062	26.508	971	3853	4068609
X067	2004 /09 /21	09:20:42	74-37.5626 N	154-30.0784 W	-0.444	26.500	1100	3856	4068608
X068	2004 /09 /21	14:05:22	74-22.6336 N	153-29.9879 W	-0.743	26.158	1076	3854	4058572
X069	2004 /09 /21	17:10:49	74-07.4047 N	152-29.9437 W	0.259	26.156	1070	3848	4058573
X070	2004 /09 /21	22:33:50	73-44.9600 N	151-58.6341 W	0.284	26.102	1058	3841	4058574
X071	2004 /09 /22	02:50:13	73-15.0906 N	152-41.2083 W	0.046	25.921	1100	3846	4058575
X072	2004 /09 /22	08:33:40	73-07.9489 N	152-29.9751 W	0.007	25.924	1100	3837	4058576
X073	2004 /09 /22	12:32:40	73-22.3916 N	153-30.0429 W	-0.213	25.777	1100	3853	4058579
X074	2004 /09 /22	17:15:52	73-37.4694 N	154-30.0379 W	0.558	26.247	1091	3857	4058577
X075	2004 /09 /22	20:12:38	73-52.7648 N	155-30.0010 W	0.905	26.112	1077	3860	4058578
X076	2004 /09 /23	00:41:46	74-04.6952 N	156-29.7133 W	-0.304	26.404	1063	3856	4058580
X077	2004 /09 /23	04:29:27	74-22.5235 N	157-29.8050 W	0.220	26.216	1100	3853	4058581
X078	2004 /09 /23	11:17:50	74-52.6559 N	159-29.5146 W	0.596	26.689	1079	1869	4058583
X079	2004 /09 /23	20:04:50	75-00.2028 N	162-59.9150 W	0.384	26.583	1075	1789	4058582
X080	2004 /09 /24	01:16:20	74-48.7479 N	163-45.5556 W	-0.405	26.597	1080	1259	4058563
X081	2004 /09 /27	02:20:18	71-54.2575 N	153-29.9029 W	2.942	27.504	598	0638	4058560
X082	2004 /09 /27	04:59:11	72-04.8283 N	154-33.9973 W	2.234	27.624	951	1395	4058561
X083	2004 /09 /27	07:48:33	72-17.6873 N	155-40.4076 W	1.539	26.547	937	1142	4058562

Table 2.2.4-1 XCTD observation log (continue)

Station	Date	Time	Latitude	Lonitude	SST	SSS	MD	WD	S/N
X084	2004 /09 /27	10:49:26	72-34.0583 N	156-45.4056 W	2.321	27.266	1100	1402	4058564
X085	2004 /09 /27	14:05:30	72-49.0702 N	157-48.4601 W	2.517	27.108	868	0903	4058565
X086	2004 /09 /28	23:58:29	71-39.6134 N	152-22.2761 W	3.422	28.145	639	0630	4058567
X087	2004 /09 /29	02:07:44	71-32.5514 N	151-50.1113 W	2.744	27.720	870	0896	4058569
X088	2004 /09 /29	04:23:10	71-23.0197 N	150-59.8663 W	3.097	27.729	266	0273	4058568
X089	2004 /09 /29	07:57:16	71-25.4498 N	150-02.1995 W	2.678	27.383	1035	1692	4058566
X090	2004 /09 /29	08:53:09	71-34.9728 N	150-01.6480 W	3.133	27.191	1036	2105	4058570
X091	2004 /09 /29	10:05:48	71-47.4978 N	150-02.3155 W	2.868	27.907	1036	2627	4058571
X092	2004 /09 /29	11:42:53	72-00.1507 N	150-02.1628 W	2.472	29.007	1036	3108	4058559
X093	2004 /09 /29	12:46:10	72-04.2247 N	150-29.9852 W	2.642	28.544	1036	3147	4058558
X094	2004 /09 /29	15:57:44	72-10.8486 N	151-29.9923 W	1.217	27.116	1036	3041	4058554
X095	2004 /09 /29	19:39:56	72-18.1886 N	152-29.7555 W	2.028	27.737	1036	2832	4058557
X096	2004 /09 /29	22:37:42	72-26.4416 N	153-30.0073 W	2.814	28.371	1036	2978	4058555
X097	2004 /09 /30	02:49:43	72-36.6341 N	154-29.9540 W	2.267	28.450	1036	3008	4058553
X098	2004 /09 /30	05:53:07	72-51.9366 N	155-29.9569 W	0.843	27.020	1033	2897	4058552
X099	2004 /09 /30	10:04:42	73-08.0962 N	156-29.9740 W	0.223	26.808	1036	2872	4058548
X100	2004 /09 /30	13:14:06	73-22.5391 N	157-30.0338 W	0.768	27.151	1036	3019	4058551
X101	2004 /09 /30	18:33:17	73-26.5726 N	158-20.0956 W	1.197	27.143	1033	2559	4058556
X102	2004 /09 /30	22:06:00	73-12.8916 N	158-09.8817 W	1.890	28.442	1033	1999	4068607
X103	2004 /10 /01	01:22:48	72-57.8419 N	157-10.0316 W	0.755	27.335	1034	1903	4068604
X104	2004 /10 /01	05:06:54	72-43.1186 N	156-10.1177 W	1.119	27.113	1034	2415	4068603
X105	2004 /10 /01	08:18:15	72-27.5834 N	155-09.9907 W	2.284	28.183	1033	2091	4058549
X106	2004 /10 /01	11:54:50	72-16.5231 N	154-09.8562 W	2.336	28.561	1036	2265	4058550
X107	2004 /10 /01	14:40:28	72-08.7524 N	153-10.0758 W	0.924	27.421	1036	1738	4068606
X108	2004 /10 /01	18:20:52	71-58.9601 N	152-14.8635 W	2.725	28.588	668	2113	4068605
X109	2004 /10 /01	20:56:14	71-48.9252 N	151-25.1037 W	2.973	28.522	1034	2268	4068602
X110	2004 /10 /02	23:19:05	71-14.9650 N	144-59.3952 W	0.932	25.908	1035	2285	4068601
X111	2004 /10 /04	02:06:43	71-36.9922 N	151-32.0056 W	2.431	28.142	1034	1503	4058600
X112	2004 /10 /05	22:18:56	73-21.0189 N	159-16.3904 W	1.717	28.765	1036	1774	4058596
X113	2004 /10 /06	05:50:36	73-55.7603 N	159-20.5716 W	0.232	26.822	-	2784	4058535
X114	2004 /10 /06	07:28:08	74-09.3327 N	160-00.0319 W	-0.322	26.803	877	0883	4058598
X115	2004 /10 /06	08:00:44	74-14.5281 N	160-14.9814 W	-0.506	26.808	473	0477	4058597

Acronyms in Table XCTD observation log are as follows;

SST: Sea Surface Temperature [deg-C] measured by Continuous Sea Surface Monitoring System

SSS: Sea Surface Salinity [PSU] measured by Continuous Sea Surface Monitoring System

MD: Maximum measured Depth [m]

WD: Water Depth [m]

(6) Data archive

XCTD data obtained during this cruise will be submitted to the JAMSTEC DMD (Data Management Division) and will be available via "R/V Mirai Data Web Page" in JAMSTEC home page.

(7) Remarks

X113; We could not output data to electronic file, due to measurement software trouble. But, we could save a graph (file name: error113.bmp).

2.3. Sea surface monitoring

(1) Personnel

Takayoshi SEIKE, Takuhei SHIOZAKI (MWJ)

(2) Objective

To measure salinity, temperature, dissolved oxygen, and fluorescence of near-sea surface water.

(3) Methods

The *Continuous Sea Surface Water Monitoring System* (Nippon Kaiyo Co. Ltd.) has six kind of sensors and can automatically measure salinity, temperature, dissolved oxygen, fluorescence and particle size of plankton in near-sea surface water continuously, every 1-minute. This system is located in the “*sea surface monitoring laboratory*” on R/V MIRAI. This system is connected to shipboard LAN-system. Measured data is stored in a hard disk of PC every 1-minute together with time and position of ship, and displayed in the data management PC machine.

Near-surface water was continuously pumped up to the laboratory and flowed into the *Continuous Sea Surface Water Monitoring System* through a vinyl-chloride pipe. The flow rate for the system is controlled by several valves and was 12L/min except with fluorometer (about 0.3L/min). The flow rate is measured with two flow meters.

Specification of the each sensor in this system of listed below.

a) Temperature and Salinity sensor

SEACAT THERMOSALINOGRAPH

Model:	SBE-21, SEA-BIRD ELECTRONICS, INC.	
Serial number:	2118859-3126	
Measurement range:	Temperature -5 to +35°C,	Salinity 0 to 6.5 S m ⁻¹
Accuracy:	Temperature 0.01 °C 6month ⁻¹ ,	Salinity 0.001 S m ⁻¹ month ⁻¹
Resolution:	Temperatures 0.001°C,	Salinity 0.0001 S m ⁻¹

b) Bottom of ship thermometer

Model:	SBE 3S, SEA-BIRD ELECTRONICS, INC.
Serial number:	032607
Measurement range:	-5 to +35°C
Resolution:	±0.001°C
Stability:	0.002 °C year ⁻¹

c) Dissolved oxygen sensor

Model: 2127A, HACH ULTRA ANALYTICS JAPAN, INC.
Serial number: 47477
Measurement range: 0 to 14 ppm
Accuracy: $\pm 1\%$ at 5 °C of correction range
Stability: 1% month⁻¹

d) Fluorometer

Model: 10-AU-005, TURNER DESIGNS
Serial number: 5562 FRXX
Detection limit: 5 ppt or less for chlorophyll a
Stability: 0.5% month⁻¹ of full scale

e) Particle Size sensor

Model: P-05, Nippon Kaiyo LTD.
Serial number: P5024
Measurement range: 0.2681 mm to 6.666 mm
Accuracy: $\pm 10\%$ of range
Reproducibility: $\pm 5\%$
Stability: 5% week⁻¹

f) Flow meter

Model: EMARG2W, Aichi Watch Electronics LTD.
Serial number: 8672
Measurement range: 0 to 30 l min⁻¹
Accuracy: $\pm 1\%$
Stability: $\pm 1\%$ day⁻¹

The monitoring Periods (UTC) during this cruise are listed below.

2-Sep.-'04 2:22 to 10-Oct.-'04 0:00

(4) Preliminary Result

Preliminary data of temperature (Bottom of ship thermometer), salinity, dissolved oxygen, fluorescence at sea surface between this cruise are shown in Figs. 1-4. These figures were drawn using Ocean Data View (R. Schlitzer,

<http://www.awi-bremerhaven.de/GEO/ODV>, 2002).

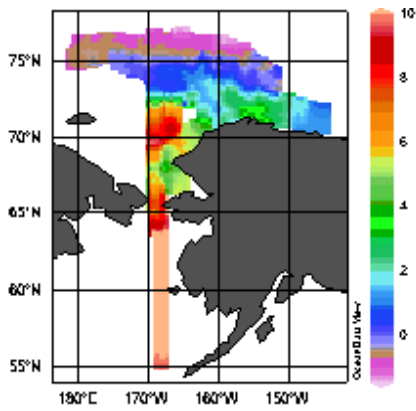

Fig.2.3-1 Contour line of temperature.

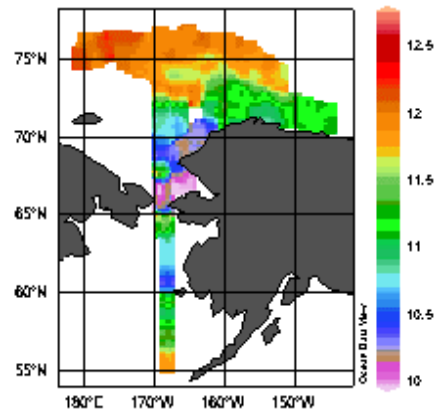

Fig.2.3-3 Contour line of dissolved oxygen.

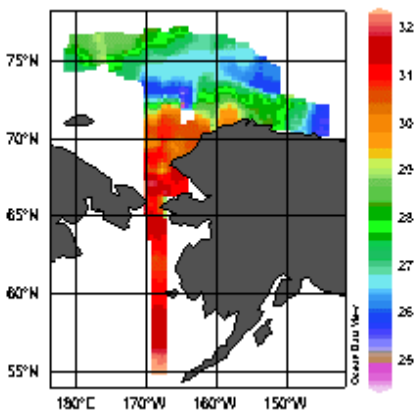

Fig.2.3-2 Contour line of salinity.

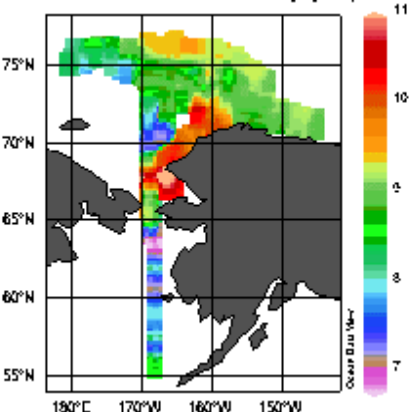

Fig.2.3-4 Contour line of fluorescence.

(5) Date archive

The data were stored on a magnetic optical disk, which will be submitted to the Data Management Office (DMO) JAMSTEC, and will be opened to public via “R/V MIRAI Data Web Page” in JAMSTEC homepage.

2.4. Oxygen Measurements

(1) Personnel

Koji SHIMADA (JAMSTEC) : Principal Investigator
Takayoshi SEIKE (MWJ) : Operation Leader
Takuhei SHIOZAKI (MWJ)

(2) Objectives

Determination of dissolved oxygen in seawater by Winkler titration.

(3) Sampling elements

Oxygen

(4) Methods and Instruments

(4-1) Reagents:

Pickling Reagent I: Manganous chloride solution (3M)
Pickling Reagent II: Sodium hydroxide (8M) / sodium iodide solution (4M)
Sulfuric acid solution (5M)
Sodium thiosulfate (0.025M)
Potassium iodate (0.001667M)

(4-2) Instruments:

Burette for sodium thiosulfate;

APB-510 manufactured by Kyoto Electronic Co. Ltd. / 10 cm³ of titration vessel

Burette for potassium iodate;

APB-410 manufactured by Kyoto Electronic Co. Ltd. / 20 cm³ of titration vessel

Detector and Software; Automatic photometric titrator manufactured by Kimoto Electronic Co. Ltd.

(4-3) Sampling

Following procedure is based on the WHP Operations and Methods (Dickson, 1996).

Seawater samples were collected with Niskin bottle attached to the CTD-system. Seawater for oxygen measurement was transferred from Niskin sampler bottle to a volume calibrated flask (ca. 100 cm³). Three times volume of the flask of seawater was overflowed. Temperature was measured by digital thermometer during the overflowing. Then two reagent solutions (Reagent I, II) of 0.5 cm³ each were added immediately into the sample flask and the stopper was inserted carefully into the flask. The sample flask was then shaken vigorously to mix the contents and to

disperse the precipitate finely throughout. After the precipitate has settled at least halfway down the flask, the flask was shaken again vigorously to disperse the precipitate. The sample flasks containing pickled samples were stored in a laboratory until they were titrated.

(4-4) Sample measurement

At least two hours after the re-shaking, the pickled samples were measured on board. A magnetic stirrer bar and 1 cm³ sulfuric acid solution were added into the sample flask and stirring began. Samples were titrated by sodium thiosulfate solution whose morality was determined by potassium iodate solution. Temperature of sodium thiosulfate during titration was recorded by a digital thermometer. During this cruise we measured dissolved oxygen concentration using two sets of the titration apparatus (DOT-1 and DOT-2). Dissolved oxygen concentration (μ mol kg⁻¹) was calculated by sample temperature during seawater sampling, salinity of the sample, and titrated volume of sodium thiosulfate solution without the blank.

(4-5) Standardization and determination of the blank

Concentration of sodium thiosulfate titrant (ca. 0.025M) was determined by potassium iodate solution. Pure potassium iodate was dried in an oven at 130°C. 1.7835 g potassium iodate weighed out accurately was dissolved in deionized water and diluted to final volume of 5 dm³ in a calibrated volumetric flask (0.001667M). 10 cm³ of the standard potassium iodate solution was added to a flask using a calibrated dispenser. Then 90 cm³ of deionized water, 1 cm³ of sulfuric acid solution, and 0.5 cm³ of pickling reagent solution II and I were added into the flask in order. Amount of sodium thiosulfate titrated gave the morality of sodium thiosulfate titrant.

The blank from the presence of redox species apart from oxygen in the reagents was determined as follows. 1 cm³ of the standard potassium iodate solution was added to a flask using a calibrated dispenser. Then 100 cm³ of deionized water, 1 cm³ of sulfuric acid solution, and 0.5 cm³ of pickling reagent solution II and I were added into the flask in order. Just after titration of the first potassium iodate, a further 1 cm³ of standard potassium iodate was added and titrated. The blank was determined by difference between the first and second titrated volumes of the sodium thiosulfate. The oxygen in the pickling reagents I (0.5 cm³) and II (0.5 cm³) were assumed to be 3.8×10^{-8} mol (Dickson, 1996).

Table 1 shows results of the Standardization and the blank determination during this cruise.

Table 2.4-1 Results of the standardization and the blank determinations during this cruise.

Date	KIO ₃	DOT-01			DOT-02		
		Na ₂ S ₂ O ₃	E.P.	Blank	Na ₂ S ₂ O ₃	E.P.	Blank
2004/09/03	040723-32	040903-1	3.958	-0.007	040903-2	3.960	-0.007
2004/09/05	040722-70	040903-1	3.954	—	040903-2	3.955	—
2004/09/06	040723-33	040903-1	3.955	-0.008	040903-2	3.956	-0.009
2004/09/07	040723-34	040903-1	3.953	-0.010	040903-2	3.957	-0.009
2004/09/07	040723-34	040903-3	3.958	-0.009	040903-4	3.960	-0.007
2004/09/08	040723-35	040903-3	3.955	-0.009	040903-4	3.958	-0.009
2004/09/09	040723-36	040903-3	3.952	-0.009	040903-4	3.956	-0.009
2004/09/09	040723-36	040903-5	3.956	-0.011	20040909-1	3.961	-0.008
2004/09/10	040723-37	040903-5	3.955	-0.010	20040909-1	3.959	-0.009
2004/09/11	040723-38	040903-5	3.956	-0.010	20040909-1	3.958	-0.008
2004/09/11	040723-38	20040909-2	3.959	-0.010	20040909-3	3.962	-0.008
2004/09/12	040723-39	20040909-2	3.959	-0.011	20040909-3	3.961	-0.011
2004/09/13	040723-40	20040909-2	3.958	-0.009	20040909-3	3.954	-0.009
2004/09/13	040723-40	20040909-4	3.959	-0.010	20040909-5	3.960	-0.010
2004/09/14	040723-41	20040909-4	3.957	-0.012	20040909-5	3.960	-0.009
2004/09/15	040723-42	20040909-4	3.959	-0.009	20040909-5	3.956	-0.007
2004/09/15	040723-42	20040913-1	3.959	-0.008	20040913-2	3.961	-0.007
2004/09/16	CSK	20040913-1	3.931	—	20040913-2	3.934	—
2004/09/16	040723-43	20040913-1	3.955	-0.009	20040913-2	3.958	-0.007
2004/09/17	CSK	20040913-1	3.945	—	20040913-2	3.952	—
2004/09/17	040723-44	20040913-1	3.953	-0.007	20040913-2	3.958	-0.005
2004/09/17	040723-47	20040913-1	3.953	—	20040913-2	3.960	—
2004/09/17	040723-47	20040913-3	3.956	-0.009	20040913-4	3.960	-0.008
2004/09/18	040723-48	20040913-3	3.957	-0.010	20040913-4	3.956	-0.008
2004/09/19	040723-49	20040913-3	3.960	-0.008	20040913-4	3.957	-0.007
2004/09/19	040723-49	20040913-5	3.957	-0.009	20040919-2	3.956	-0.008
2004/09/20	040723-50	20040913-5	3.956	-0.007	20040919-2	3.955	-0.008
2004/09/21	040723-51	20040913-5	3.956	-0.006	20040919-2	3.954	-0.007
2004/09/21	040723-51	20040919-3	3.956	-0.008	20040919-4	3.959	-0.007
2004/09/22	040723-52	20040919-3	3.958	-0.009	20040919-4	3.960	-0.008
2004/09/22	CSK	20040919-3	3.769	—	20040919-4	3.609	—
2004/09/23	040723-53	20040919-3	3.962	-0.008	20040919-4	3.961	-0.007
2004/09/23	040723-53	20040919-5	3.964	-0.012	20040922-1	3.969	-0.007
2004/09/24	CSK	20040919-5	3.959	—	20040922-1	3.961	—
2004/09/24	040723-54	20040919-5	3.962	-0.009	20040922-1	3.966	-0.007
2004/09/25	040723-55	20040919-5	3.962	-0.008	20040922-1	3.967	-0.008
2004/09/25	040723-55	20040922-3	3.963	-0.011	20040922-2	3.967	-0.007
2004/09/26	040723-56	20040922-3	3.961	-0.008	20040922-2	3.966	-0.007
2004/09/27	040723-57	20040922-3	3.963	-0.008	20040922-2	3.966	-0.008
2004/09/27	040723-57	20040922-4	3.964	-0.011	20040922-5	3.968	-0.007
2004/09/30	040723-58	20040922-4	3.963	-0.010	20040922-5	3.968	-0.007
2004/10/01	040723-59	20040922-4	3.963	-0.009	20040922-5	3.969	-0.004
2004/10/01	040723-62	20040922-4	3.962	—	20040922-5	3.967	—
2004/10/01	040723-62	20040929-1	3.961	-0.010	20040929-2	3.965	-0.006
2004/10/01	040723-63	20040929-1	3.962	-0.010	20040929-2	3.966	-0.010
2004/10/03	040723-64	20040929-1	3.967	-0.006	20040929-2	3.968	-0.005
2004/10/03	040723-64	20040929-3	3.963	-0.009	20040929-4	3.968	-0.008
2004/10/04	040723-65	20040929-3	3.965	-0.006	20040929-4	3.967	-0.007
2004/10/04	040722-72	20040929-3	—	—	20040929-4	3.965	—
2004/10/05	040723-66	20040929-3	3.962	-0.006	20040929-4	3.967	-0.005
2004/10/05	040723-66	20040929-5	3.964	-0.007	20041004-1	3.992	-0.005
2004/10/07	040722-73	20040929-5	—	—	—	—	—
2004/10/07	040722-73	20040929-5	3.921	—	—	—	—
2004/10/08	040723-70	20040929-5	3.968	-0.007	20041004-1	3.997	-0.008
2004/10/09	CSK	20040929-5	3.958	—	20041004-1	3.985	—
2004/10/09	040723-67	20040929-5	3.965	-0.006	20041004-1	3.995	-0.005

(5) Reproducibility of sample measurement

During this cruise we measured oxygen concentration in 2830 seawater samples at 152 stations. Replicate samples were taken at every CTD cast; usually these were 5 - 10 % of seawater samples of each cast during this cruise. Results of the replicate samples were shown in Table 2 and this histogram shown in Fig.1. The standard deviation was calculated by a procedure (SOP23) in DOE (1994).

Table 2.4-2 Results of the replicate sample measurements

Number of replicate sample pairs	Oxygen concentration (μ mol/kg)
	Standard Deviation.
464	0.11

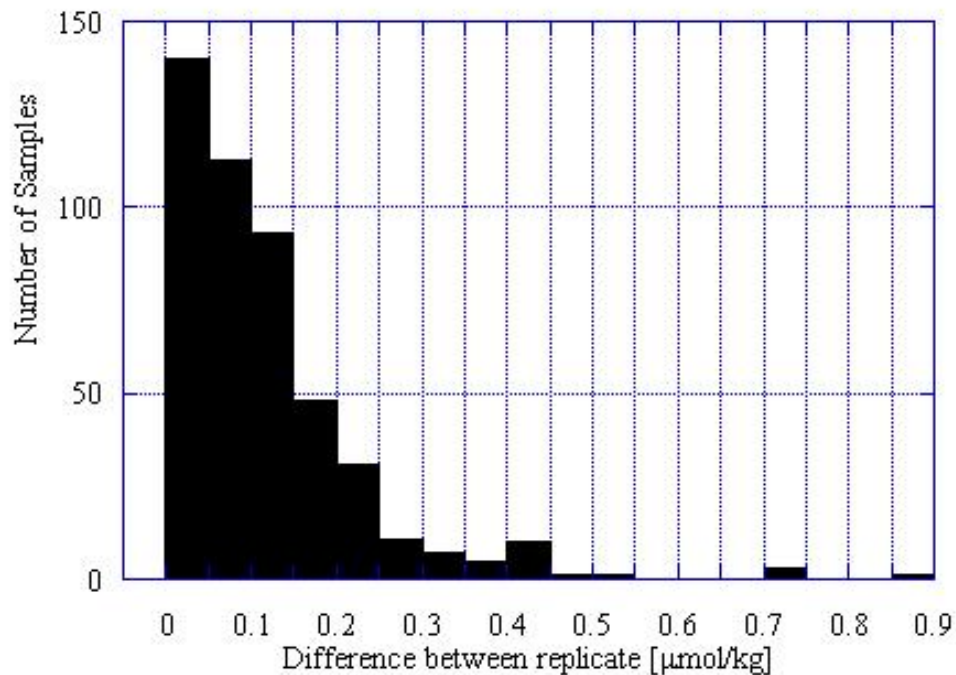

Fig. 2.4-1 Results of the replicate sample measurements

(6) Data archives

All raw and processed data files were submitted to Chief Scientist.

(7) References

Dickson, A. (1996) Dissolved Oxygen, in WHP Operations and Methods, Woods Hole, pp1-13.

DOE (1994) Handbook of methods for the analysis of the various parameters of the

carbon dioxide system in sea water; version 2. A.G. Dickson and C. Goyet (eds), ORNL/CDIAC-74.

Emerson, S, S. Mecking and J. Abell (2001) The biological pump in the subtropical North Pacific Ocean: nutrient sources, redfield ratios, and recent changes. *Global Biogeochem. Cycles*, 15, 535-554.

Watanabe, Y. W., T. Ono, A. Shimamoto, T. Sugimoto, M. Wakita and S. Watanabe (2001) Probability of a reduction in the formation rate of subsurface water in the North Pacific during the 1980s and 1990s. *Geophys. Res. Letts.*, 28, 3298-3292.

2.5. Nutrients

2.5.1 Water column nutrients

(1) Personnel

Shigeto NISHINO (JAMSTEC): Principal Investigator

Kenichiro SATO (MWJ): Operation Leader

Asako KUBO (MWJ)

Ayumi TAKEUCHI (MWJ)

Shinichiro YOKOGAWA (WMJ)

Kohei MIURA (MWJ)

(2) Objectives

The vertical and horizontal distributions of the nutrients are one of the most important factors on the primary production. During this cruise nutrient measurements will give us the important information on the mechanism of the primary production or seawater circulation.

(3) Sampling elements

Nitrate

Nitrite

Silicic acid (silicate)

Phosphate

Ammonium.

(4) Instruments and Methods

Nutrient analysis was performed on two BRAN+LUEBBE TRAACS 800 systems. One system had 4 colorimeter detectors for nitrate, nitrite, silicate and phosphate. The other one was for ammonium. The systems of analysis were improved which proposed for nutrients of seawater by BRAN+LUEBBE. The new systems flow diagram are shown from Fig. 1 to 5. The laboratory temperature was maintained between 20 - 25 deg C.

(4-1) Measured Parameters

Nitrite: Nitrite was determined by diazotizing with sulfanilamide and coupling with N-1-naphthyl-ethylenediamine (NED) to form a colored azo dye that was measured absorbance of 550 nm using 5 cm length cell.

Nitrate: Nitrate in seawater is reduced to nitrite by reduction tube (Cd - Cu tube), and the nitrite determined by the method described above, but the flow cell

used in nitrate analysis was 3 cm length cell. Nitrite initially present in the sample is corrected.

Silicate: The standard AAI molybdate-ascorbic acid method was used. The silicomolybdate produced is measured absorbance of 630 nm using a 3 cm length cell.

Phosphate: The method by Murphy and Riley (1962) was used with separate additions of ascorbic acid and mixed molybdate-sulfuric acid-tartrate. The phospho-molybdate produced is measured absorbance of 880 nm using a 5 cm length cell.

Ammonium: Ammonium in seawater was mixed with an alkaline solution containing EDTA, ammonium as gas state was formed from seawater. The ammonium (gas) was absorbed in sulfuric acid solution by way of 0.5 μm pore size membrane filter (ADVANTEC PTFE) at the attached to analytical system. The ammonium absorbed in acid solution was determined by coupling with phenol and hypochlorite solution to form an indophenol blue compound. That compound produced is measured absorbance of 630 nm using a 3 cm length cell.

Nutrients reported in micromoles per kilogram were converted from micromoles per liter by dividing by density calculated at sample temperature.

(4-2) Nutrients Standard

Silicate standard solution, the silicate primary standard, is obtained from Kanto Chemical CO., Inc. This standard solution is 1000 mg per liter with 0.5 M KOH and prepared for ICP analysis. Primary standard for nitrate (KNO_3), nitrite (NaNO_2), phosphate (KH_2PO_4) and ammonium ($(\text{NH}_4)_2\text{SO}_4$) obtained from Wako Pure Chemical Industries, Ltd. Sets of 4 different concentrations of shipboard standards were analyzed at beginning and end of each group of analysis.

(4-3) Sampling Procedures

Samples were drawn into 10 ml acrylic screw-capped tubes that were rinsed three times before filling. Each sample was analyzed two times as soon as possible.

(4-4) Low Nutrients Sea Water (LNSW)

Twelve containers (20L) of low nutrients seawater were collected in January 2002 at equatorial Pacific and filtered with 0.45 μm pore size membrane filter (Millipore HA). They are used as preparing the working standard solution.

(5) Results

Nutrients analysis of the 152 stations (5,342 samples for nitrate, nitrite, silicate and phosphate, 3,284 samples for ammonium) from the carousel was performed including surface seawaters collected by bucket. Duplicate samples, excluding parts of ammonium samples, were collected from all bottles of each casting. Coefficient of variation (CV) of nitrate, nitrite, silicate, phosphate and ammonium analysis at each station were less than 0.19% (36 μM), 0.31% (0.8 μM), 0.18% (115.2 μM), 0.28% (2.4 μM) and 0.98% (6.4 μM), respectively.

(6) Data archives

All raw and processed nutrients data files were copied onto CD-ROM and submitted to Chief Scientist.

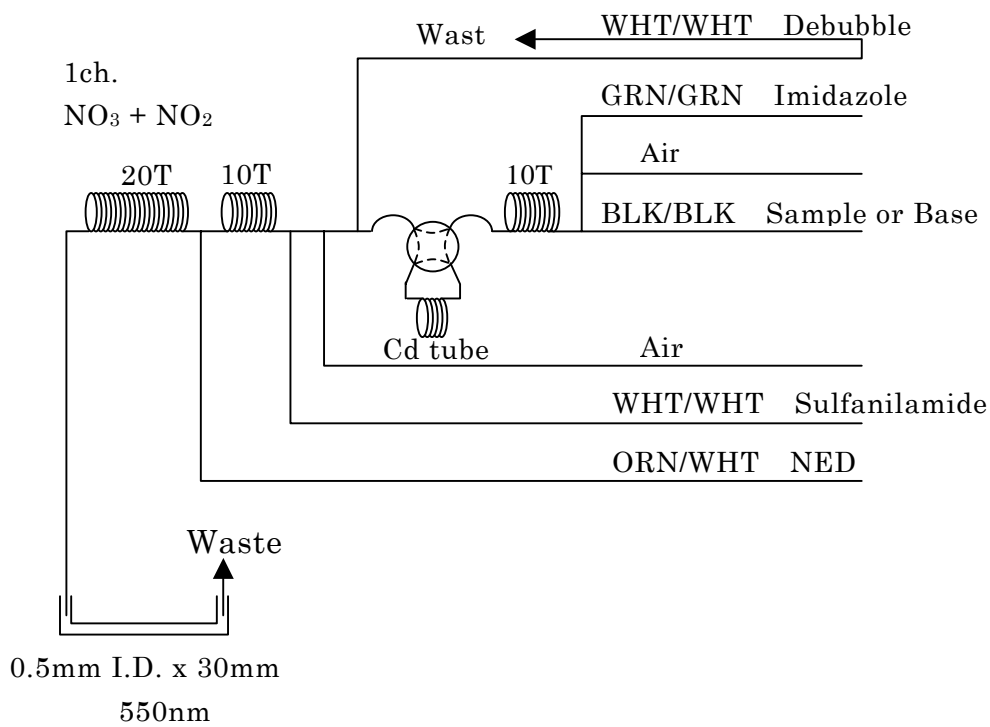

Fig. 2.5.1-1 (NO₃+NO₂) Flow diagram.

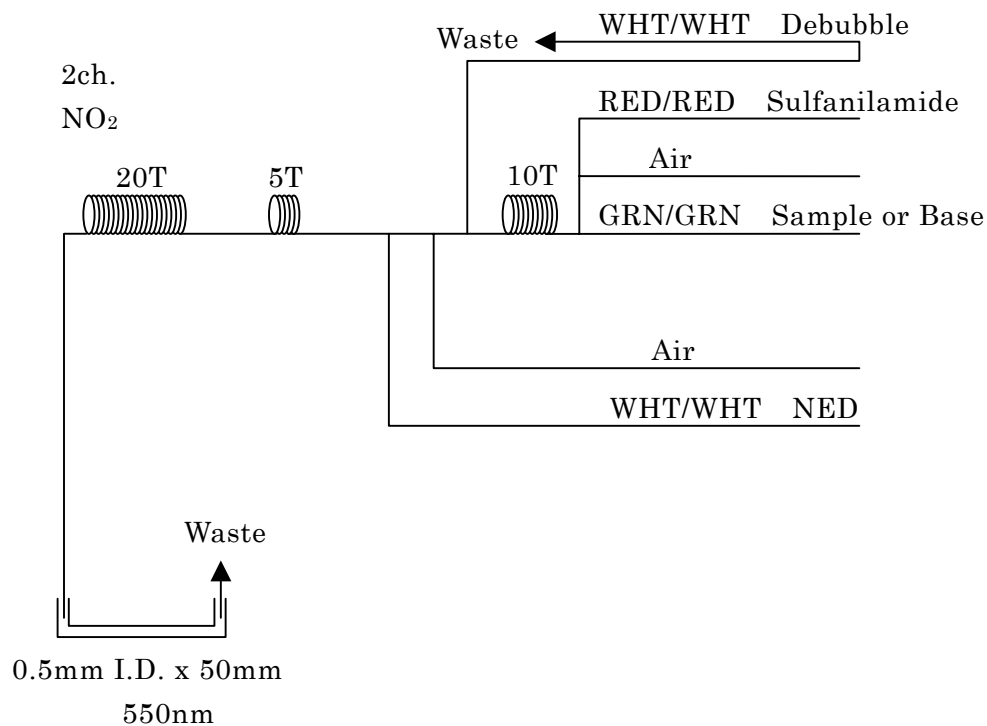

Fig. 2.5.1-2 (NO₂) Flow diagram.

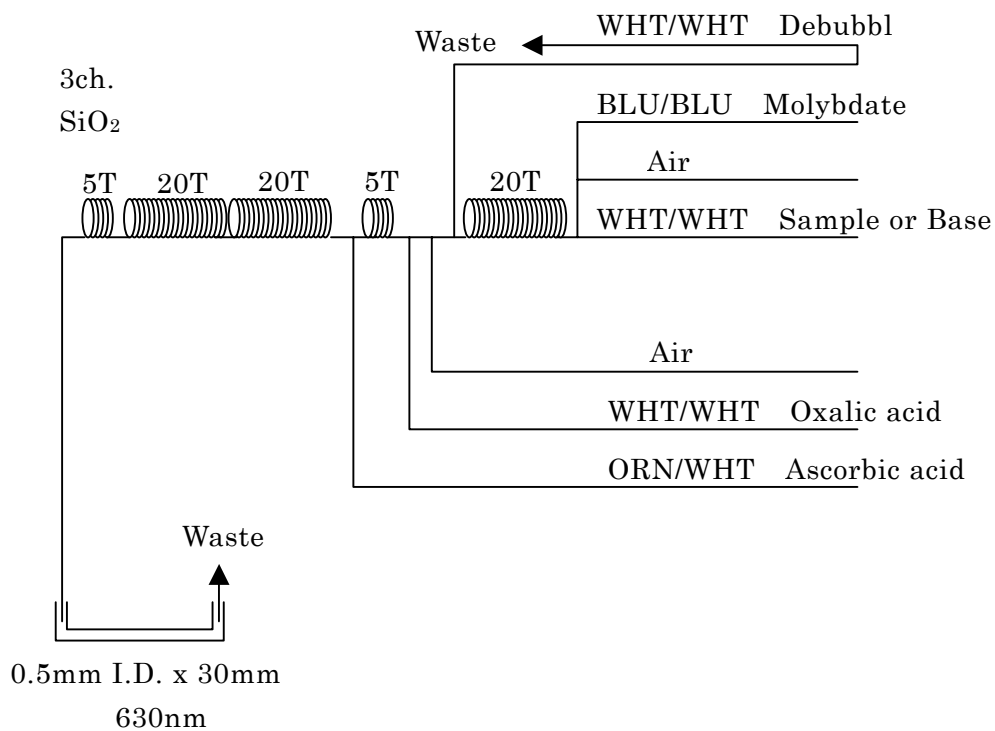

Fig. 2.5.1-3 (SiO₂) Flow diagram.

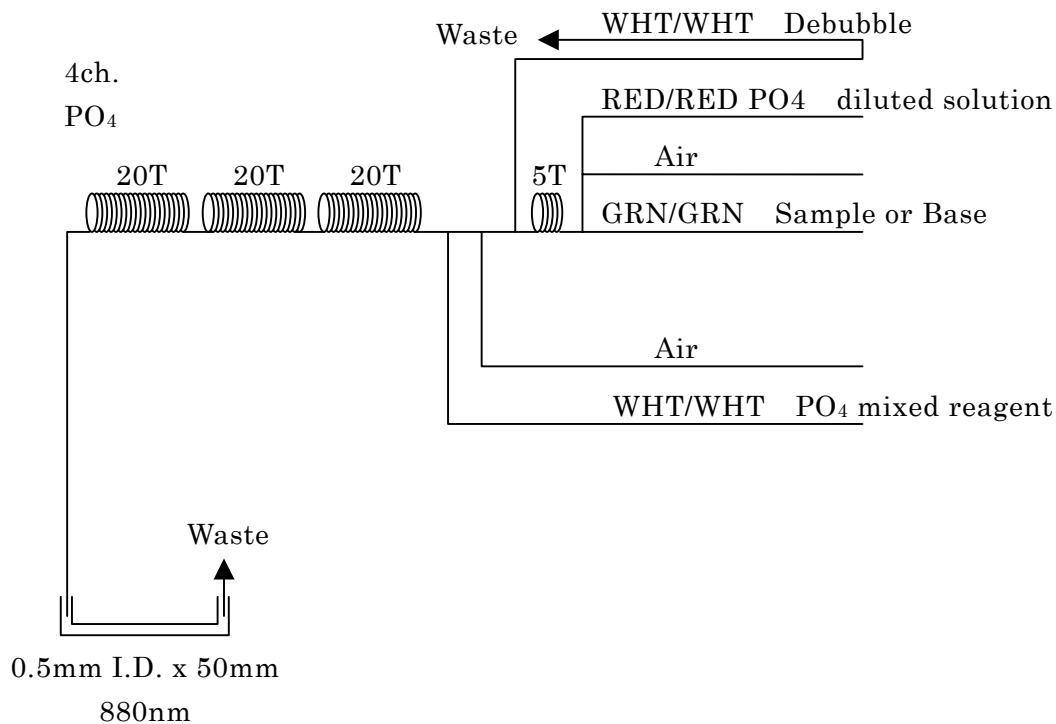

Fig. 2.5.1-4 (PO₄) Flow diagram.

3ch.
NH₄

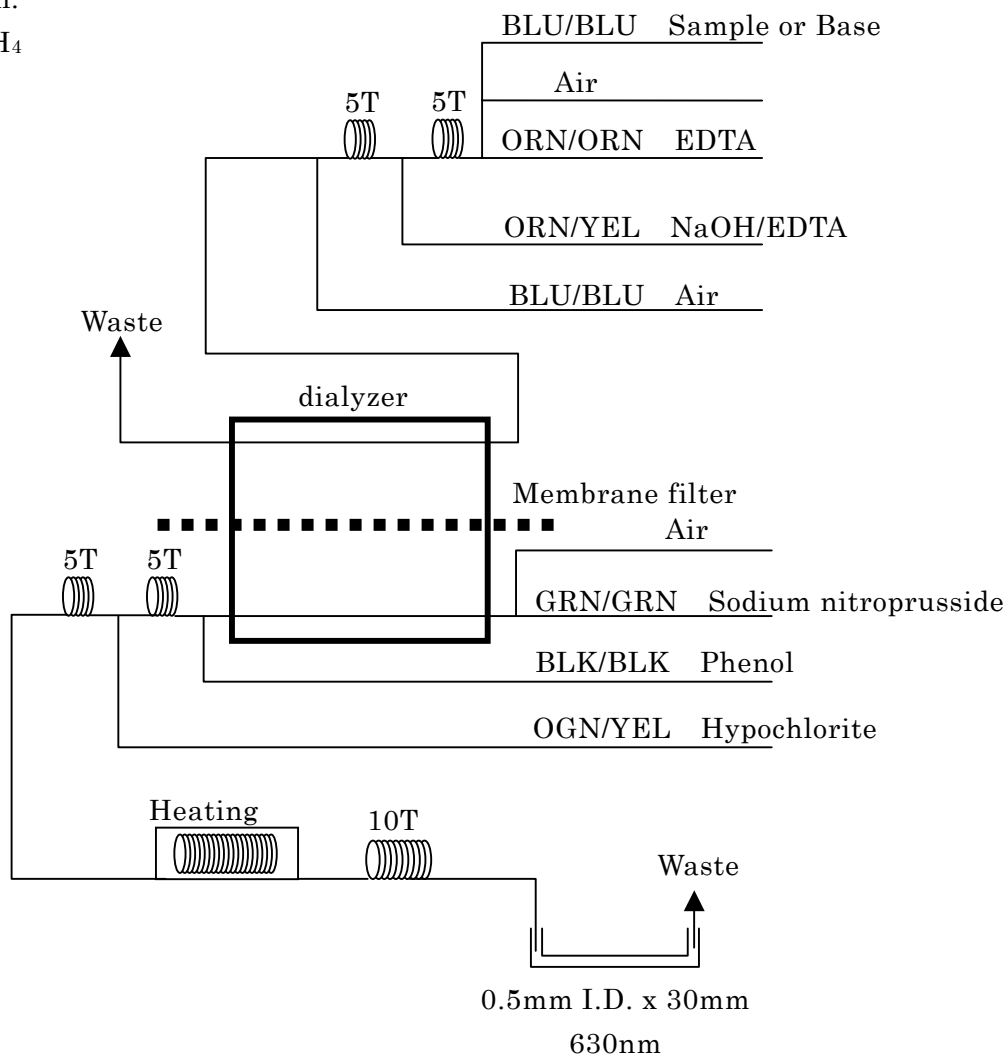

Fig. 2.5.1-5 (NH₄) Flow diagram.

2.5.2 Sea surface nutrients

(1) Personnel

Asako Kubo (MWJ)
Kenichiro Sato (MWJ)
Ayumi Takeuchi (MWJ)
Shinichiro Yokogawa (MWJ)

(2) Objective

We revealed the distribution of nutrients in surface seawater that is important to investigate primary production.

(3) Measured parameters

- Nitrate
- Nitrite
- Silicic acid
- Phosphate

(4) Methods

The nutrients monitoring system was performed on BRAN+LUEBBE continuous monitoring system Model TRAACS 800 (4 channels). It was located at the surface seawater laboratory for monitoring in R/V Mirai. The seawater of 4.5 m depth under sea surface was continuously pumped up to the laboratory inner R/V Mirai. The seawater was poured in 5 L of polyethylene beaker through a faucet of the laboratory. The seawater was introduced direct to monitoring system with narrow tube continuously. The methods are as follows.

Nitrate: Nitrate in the seawater was reduced to nitrite by reduction tube (Cd-Cu tube) and the nitrite reduced was determined by the nitrite method described to next, but the flow cell used in nitrate analysis was 3 cm length type. Nitrite initially present in the seawater was corrected after measuring.

Nitrite: Nitrite was determined by diazotizing with sulfanilamide by coupling with N-1-naphthyl-ethylenediamine (NED) to form a colored azo compound, and by being measured the absorbance of 550 nm using 3 cm length flow cell in the system.

Phosphate: Phosphate was determined by complexing with molybdate, by reducing with ascorbic acid to form a colored complex, and by being measured the absorbance of 800 nm using 5 cm length flow cell in the system.

Silicate: Silicate was determined by complexing with molybdate, by reducing with ascorbic acid to form a colored complex, and by being measured the absorbance of 800 nm using 3 cm length flow cell in the system.

(5) Preliminary results

The nutrients monitoring was operated during the period of 2004/9/2-2004/10/9. Monitoring data was obtained every 1 minute. If there are “nd” in those data, it means noise or not measured period due to malfunction, adjustment and changing reagent.

(6) Data archive

These data were copied onto CD-ROM and submitted to Chief Scientist.

2.6. Partial Pressure of CO₂ (pCO₂) Measurement

(1) Personnel

Shigeto Nishino (JAMSTEC)

Masaki MORO (MWJ)

Taeko Ohama (MWJ)

Yoshiko Ishikawa (MWJ)

(2) Objective

Concentrations of CO₂ in the atmosphere are now increasing at a rate of 1.5 ppmv y⁻¹ owing to human activities such as burning of fossil fuels, deforestation, and cement production. The magnitude of the anticipated global warming depends on the levels of CO₂ in the atmosphere. Since the ocean currently absorbs 1/3 of the carbon emitted into the atmosphere (6Gt each year) by human activities, it is an urgent task to estimate absorption capacity of the oceans against the increased atmospheric CO₂ as accurately as possible and to clarify the mechanism of the CO₂ absorption.

In this cruise, we are aimed at quantifying the anthropogenic CO₂ absorbed in the surface ocean in the Arctic region, where data for CO₂ are sparse. For the purpose, we measured pCO₂ (partial pressure of CO₂) in the atmosphere and surface seawater.

(3) Measured Parameters

Partial pressure of CO₂ in the atmosphere and surface seawater

(4) Apparatus and performance

Concentrations of CO₂ in the surface seawater and sea surface atmosphere were measured continuously during the cruise using an automated system with a non-dispersive infrared (NDIR) analyzer (BINOS™). The automated system was operated in a one-and-a-half-hour cycle, which contained analysis of standard gasses, surface seawater and sea surface atmosphere. The concentrations of the standard gasses were 268.84, 330.16, 369.37 and 414.39ppm.

The sea surface atmosphere taken from the bow was introduced into the NDIR by passing through a mass flow controller which controlled the flow rate at about 0.5 L/min, a cooling unit, a perma-pure dryer (GL Sciences Inc.) and a desiccant holder containing Mg(ClO₄)₂.

A fixed volume of the sea surface atmosphere taken from the bow was equilibrated with a stream of seawater that flowed at a rate of 5-6L/min in the equilibrator. The air in the equilibrator was circulated with a pump at 0.7-0.8L/min in a closed loop passing through two cooling units, a perma-pure dryer (GL Science Inc.) and a desiccant holder

containing $\text{Mg}(\text{ClO}_4)_2$.

Further details for the method of analysis could be found in DOE (1994).

(5) Preliminary results

Figure 2.6-1 is showing the results of measuring the CO_2 concentration ($x\text{CO}_2$) of ambient air samples and the seawater samples.

(6) Data Archive

All data was submitted to JAMSTEC Data Management Office (DMO) and is currently under its control.

(7) Reference

DOE (1994), *Handbook of methods for the analysis of the various parameters of the carbon dioxide system in sea water*; version 2, A. G. Dickson & C. Goyet, Eds., ORNS/CDIAC-74.

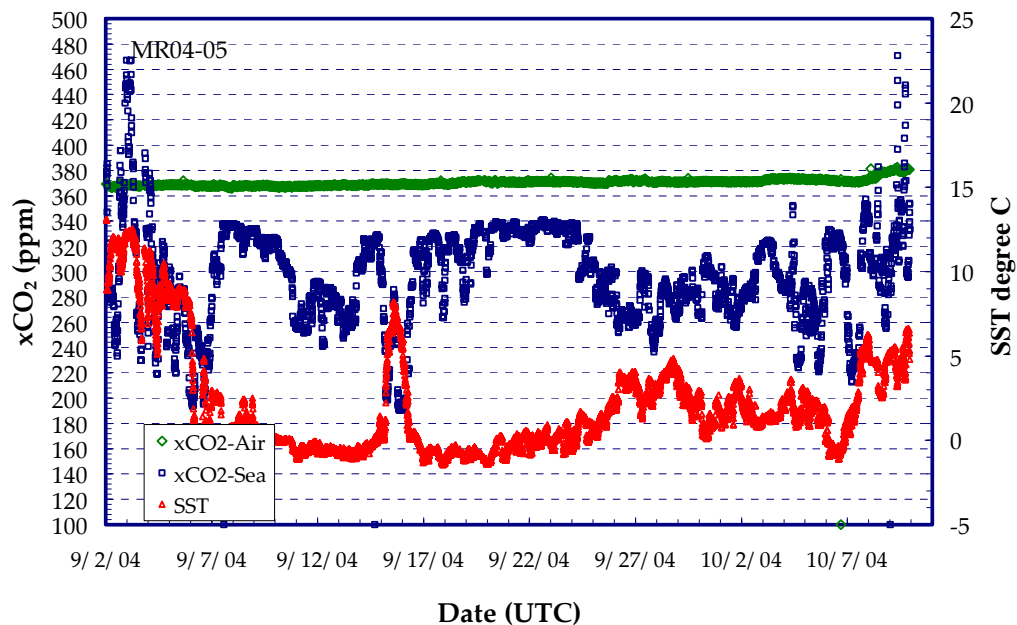

Fig. 2.6-1 Concentrations of CO_2 ($x\text{CO}_2$) in surface seawater (blue) and sea surface atmosphere (green) with SST (red) during the cruise in the Arctic region.

2.7. Total Dissolved Inorganic Carbon Measurement

(1) Personnel

Shigeto NISHINO (JAMSTEC)
Hideki YAMAMOTO (MWJ)
Minoru KAMATA (MWJ)
Yuichi SONOYAMA (MWJ)

(1) Objectives

Chlorofluorocarbons (CFCs) are the artificially formed gas. CFC-11 (CCl_3F), CFC-12 (CCl_2F_2), CFC-113 ($\text{C}_2\text{Cl}_3\text{F}_3$) are useful chemical tracers to clarify the water movement. We determined dissolved CFC-11, CFC-12, CFC-113 concentrations in seawater on board.

(2) Apparatus

Dissolved CFCs concentrations in seawater were determined with an electron capture detector - gas chromatograph (ECD-GC) attached the purge and trapping system.

Table 2.7 - 1 Instruments and analytical conditions

Instruments	
Gas Chromatograph:	GC-14B (Shimadzu Ltd.)
Detector:	ECD-14 (Shimadzu Ltd)
Column:	
Pre column:	Pola BOND – Q (i. d.: 0.53mm, length: 2m, tick: 6.0 μm)
Main column:	Pola BOND – Q (i. d.: 0.53mm, length: 7m, tick: 6.0 μm) & Plot Fused Silica (i.d.:0.53mm, length: 30m, tick 0.25 μm)
Oven:	95 deg-C
Detector:	250 deg-C
Temperature	
Trapping & desorbing:	-45 deg-C & 130 deg-C
Gas flow rate	
Carrier gas:	17 ml/min
Detector Make UP:	20 ml/min
Column Purge:	30 ml/min
Sample purge:	190 - 200 ml/min

(3) Procedures

(3-1) Sampling

Seawater samples for CFCs measurement were collected from 12 liter Niskin bottles to N₂ purged 300ml glass bottle with specially ordered Swagelok unions. Two times bottle volumes of seawater sample were overflowed to minimize contamination with atmospheric CFCs.

Air samples for CFCs measurement were collected to 100ml glass cylinder at the navigation deck on R/V "MIRAI".

(3-2) Analysis

The CFCs analytical system was modified from the original design of Bullister and Weiss (1988). Sample volume was 50ml. The trap used to hold CFCs consists of a length of 1/8 in. o.d. SS tubing packed with 3 cm of Porapak® type T (80/100 mesh) and 5 cm of Res-Sil™ C. Trapping and desorbing temperature were - 45 deg-C and 130 deg -C, respectively. The trapped gas was transformed to GC system directly. Analytical conditions were bellow.

(4) Performance

The precisions of CFC-11, CFC-12 and CFC-113 were ± 0.03 pmol/kg (n =54), ± 0.04 pmol/kg (n = 56) and ± 0.01 pmol/kg (n = 54), respectively obtained from duplicate determinations. The standard gases used in this cruise will be calibrated to SIO scale standard gases after the cruise, and then the data will be corrected.

(5) Data archive

All data will be submitted to JAMSTEC Data Management Office (DMO) and under its control.

(6) Reference

Bullister, J.L and Weiss R.F. 1988. Determination of CCl₃F and CCl₂F₂ in seawater and air. Deep Sea Research, 35, 839-853.

2.8. Total alkalinity

(1) Personnel

Shigeto Nishino	(JAMSTEC)
Taeko Ohama	(MWJ)
Masaki Moro	(MWJ)
Yoshiko Ishikawa	(MWJ)

(2) Method and Instruments

The Samples of total alkalinity obtained shallower than 300m of sampling layer. As for the sample of the obtained seawater, capacity was flowed in the bottle made of the glass of 125ml by 12L Niskin TM bottle. Seawater was filled from the bottom of the sampling bottle, and the two double of the amounts were overflowed. The bottle was sealed with the screw top next, and stored in the refrigerator. The bottles were put in the water bath kept about 25°C before the titration.

Approximately 40ml of the seawater sample was transferred into a water-jacketed titration cell from the glass bottle using a water-jacketed calibrated pipette. The samples were titrated with a solution of 0.05M hydrochloric acid and 0.65M sodium chloride. The whole titration procedure was carried out automatically. The titration systems, TA-1000 (made by NIHON ANS ltd.)-B, composed of 5 devices, a main unit and an auto sampler, an auto-burette (Metrohm), a pH meter (Thermo Orion), a thermostat bath and one computer. Measurement of electric motive force was used a combined pH electrode (Thermo Orion). Prior to the titration, all of the samples were kept in a 25deg-C thermostat bath, in which the titration was also carried out. The acid used for the titration was calibrated by measuring alkalinity of 6 different concentrations of Na₂CO₃, ranging from 0 to 2500 μmol/kg, in 0.7N NaCl solutions. Modified Gran functions were applied to calculate the alkalinity of the samples.

(3) Preliminary results

Replicate samples were made on every station about two sets. The absolute differences between the duplicate samples of the TA-1000-B were plotted on a range control chart (see Fig. 2.8-1). The differences of the standard deviation was 1.68 μmol/kg (n=156). We achieved the precision of recommended value or less (2μmol/kg) of DOE(1994).

We measured two kinds of control sample, SIO CRM batch 60 and 65, and evaluated the stability of the measurement process. Measurements values of CRM were plotted sequentially and shown in Fig. 2.8-2 and 2.8-3 .

(4) References

DOE (1994) Handbook of methods for the analysis of the various parameters of the carbon dioxide system in sea water; version 2, A.G. Dickson & C. Goyet, eds. ORNS/CDIAC-74.

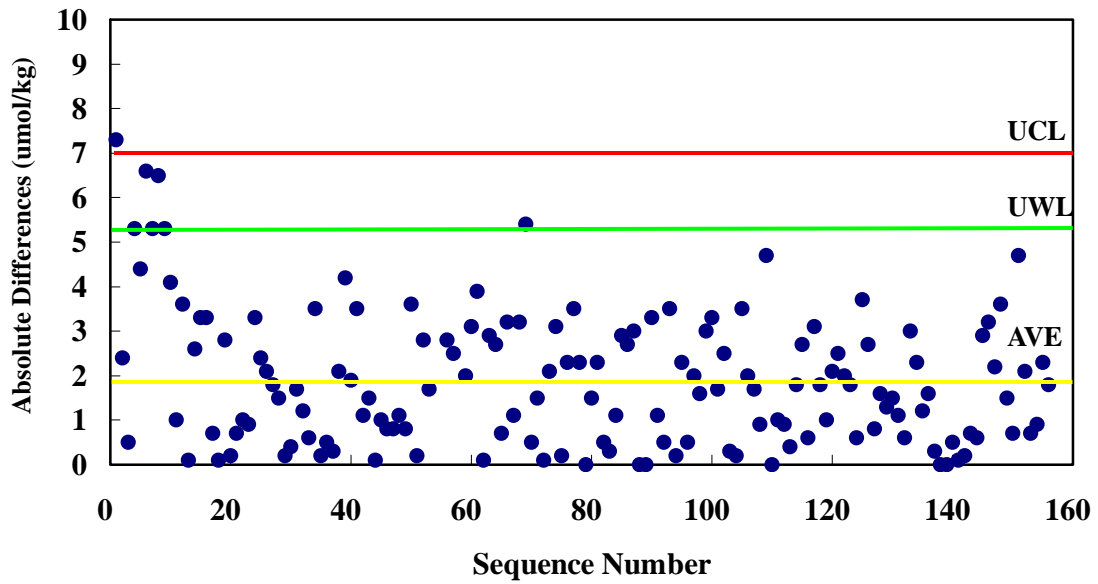

Fig. 2.8-1 Differences of duplicate measurements

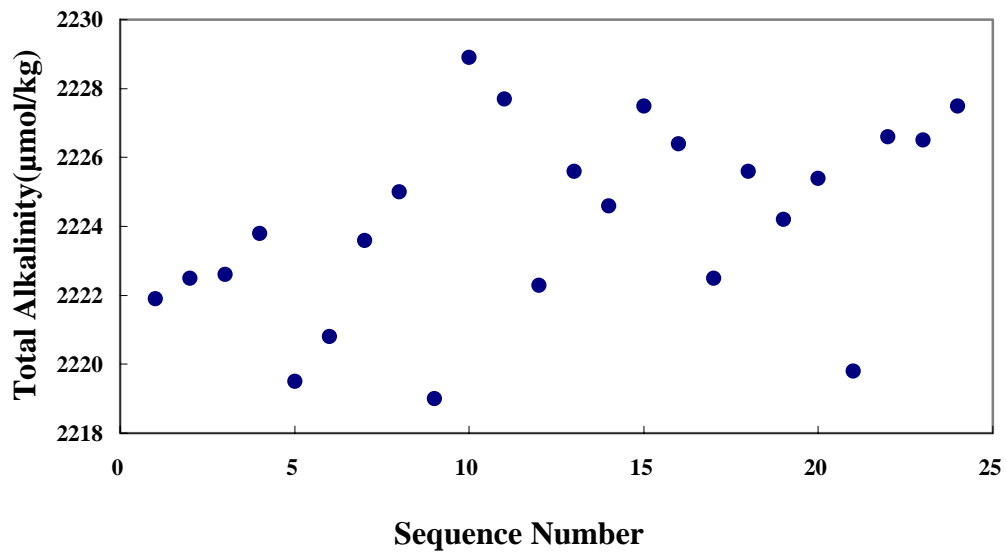

Fig. 2.8-2 Measurement results of CRM batch 60

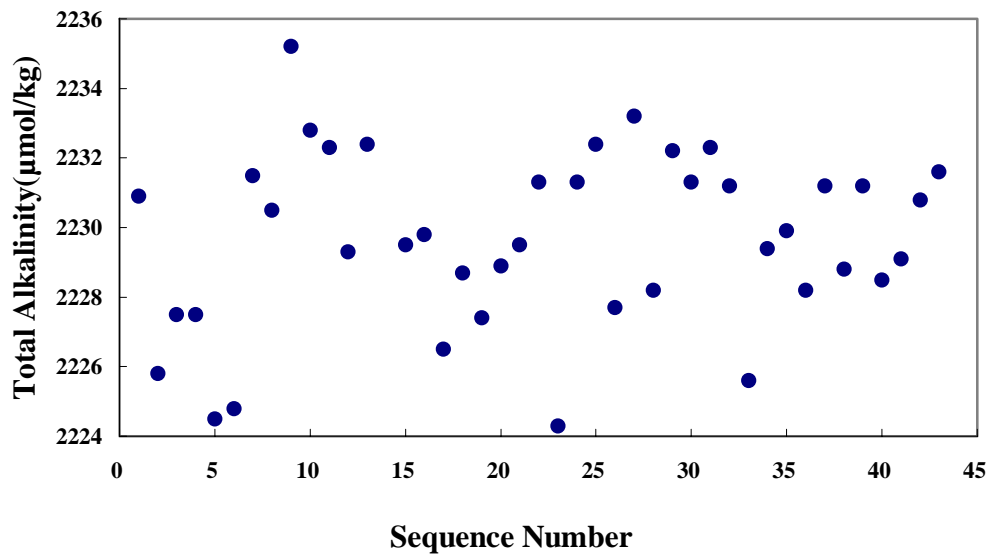

Fig. 2.8-3 Measurement results of CRM batch 65

2.9. Water Sampling Inventory

Station	Salinity	O2	PO4	SiO2	NO3	NO2	NH4	CFC-11	CFC-12	CFC-113	Alk	CHL A	CHL A GF/F-2	CHL A 2-5	CHL A 5-10	CHL A >10
A04006	*	*	*	*	*	*	*	-	-	-	*	-	-	-	-	-
A04007	*	*	*	*	*	*	*	-	-	-	-	*	*	*	*	*
A04009	*	*	*	*	*	*	*	-	-	-	*	*	*	*	*	*
A04011	*	*	*	*	*	*	*	-	-	-	*	*	*	*	*	*
A04015	*	*	*	*	*	*	*	*	*	*	*	*	*	*	*	*
A04016	-	*	*	*	*	*	*	*	*	*	*	*	*	*	*	*
A04017	*	*	*	*	*	*	*	*	*	*	*	*	-	-	-	-
A04018	*	*	*	*	*	*	*	*	*	*	*	*	-	-	-	-
A04019	*	*	*	*	*	*	*	-	-	-	*	-	-	-	-	-
A04020	*	*	*	*	*	*	*	*	*	*	-	-	-	-	-	-
A04021	*	*	*	*	*	*	*	-	-	-	*	-	-	-	-	-
A04023	*	*	*	*	*	*	*	*	*	*	-	*	*	*	*	*
A04024	*	*	*	*	*	*	*	-	-	-	*	*	*	*	*	*
A04030	*	*	*	*	*	*	*	*	*	*	*	-	-	-	-	-
A04032	*	*	*	*	*	*	*	*	*	*	*	*	*	*	*	*
A04035	*	*	*	*	*	*	*	*	*	*	*	*	*	*	*	*
A04036	*	*	*	*	*	*	*	*	*	*	*	*	*	*	*	*
A04040	*	*	*	*	*	*	*	*	*	*	*	-	-	-	-	-
A04041	*	*	*	*	*	*	*	*	*	*	*	-	-	-	-	-
A04042	*	*	*	*	*	*	*	-	-	-	*	*	*	*	*	*
A04043	*	*	*	*	*	*	*	*	*	*	*	*	-	-	-	-
A04044	*	*	*	*	*	*	*	*	*	*	-	*	-	-	-	-
A04045	*	*	*	*	*	*	*	*	*	*	*	*	*	*	*	*
A04046	*	*	*	*	*	*	*	-	-	-	-	-	-	-	-	-
A04047	*	*	*	*	*	*	*	*	*	*	*	-	*	*	*	*
A04048	*	*	*	*	*	*	*	-	-	-	-	-	*	*	*	*
A04049	*	*	*	*	*	*	*	-	-	-	*	*	*	*	*	*
A04050	*	*	*	*	*	*	*	*	*	*	*	*	*	*	*	*
A04051	*	*	*	*	*	*	*	*	*	*	*	*	-	-	-	-
A04052	*	*	*	*	*	*	*	-	-	-	*	-	-	-	-	-
A04053	*	*	*	*	*	*	*	-	-	-	*	-	-	-	-	-
A04055	*	*	*	*	*	*	*	-	-	-	*	*	*	*	*	*
A04056	*	*	*	*	*	*	*	*	*	*	*	*	-	-	-	-
A04057	*	*	*	*	*	*	*	-	-	-	-	*	-	-	-	-
A04058	*	*	*	*	*	*	*	*	*	*	-	*	-	-	-	-
A04059	*	*	*	*	*	*	*	*	*	*	*	*	*	*	*	*
A04060	*	*	*	*	*	*	*	*	*	*	*	-	-	-	-	-
A04061	*	*	*	*	*	*	*	-	-	-	*	-	-	-	-	-
A04062	*	*	*	*	*	*	*	-	-	-	*	-	-	-	-	-
A04063	*	*	*	*	*	*	*	*	*	*	*	*	-	-	-	-
A04072	-	*	*	*	*	*	*	*	*	*	*	*	-	-	-	-
A04073	-	*	*	*	*	*	*	*	*	*	*	*	-	-	-	-
A04074	-	*	*	*	*	*	*	-	-	-	*	-	-	-	-	-
A04075	-	*	*	*	*	*	*	-	-	-	*	-	-	-	-	-
A04076	-	*	*	*	*	*	*	-	-	-	*	-	-	-	-	-
A04077	*	*	*	*	*	*	*	-	-	-	*	-	-	-	-	-
A04078	*	*	*	*	*	*	*	-	-	-	*	-	-	-	-	-
A04079	*	*	*	*	*	*	*	*	*	*	*	*	-	-	-	-
A04080	*	*	*	*	*	*	*	-	-	-	*	-	-	-	-	-
A04081	*	*	*	*	*	*	*	*	*	*	-	-	-	-	-	-
A04082	*	*	*	*	*	*	*	*	*	*	*	-	-	-	-	-

Station	Salinity	O2	PO4	SiO2	NO3	NO2	NH4	CFC-11	CFC-12	CFC-113	Alk	CHL A	CHL A GF/F-2	CHL A 2-5	CHL A 5-10	CHL A >10
A04083	*	*	*	*	*	*	*	*	*	*	*	*	-	-	-	-
A04084	*	*	*	*	*	*	*	*	*	*	*	-	-	-	-	-
A04085	*	*	*	*	*	*	*	-	-	-	-	*	-	-	-	-
A04086	*	*	*	*	*	*	*	-	-	-	-	*	-	-	-	-
A04087	*	*	*	*	*	*	*	-	-	-	-	-	-	-	-	-
A04088	*	*	*	*	*	*	*	-	-	-	*	-	-	-	-	-
A04089	*	*	*	*	*	*	*	*	*	*	*	-	-	-	-	-
A04090	*	*	*	*	*	*	*	*	*	*	*	*	-	-	-	-
A04091	*	*	*	*	*	*	*	-	-	-	-	*	-	-	-	-
A04092	*	*	*	*	*	*	*	-	-	-	-	-	-	-	-	-
A04098	*	*	*	*	*	*	*	*	*	*	*	*	-	-	-	-
A04100	*	*	*	*	*	*	*	*	*	*	*	-	-	-	-	-
A04103	*	*	*	*	*	*	*	-	-	-	-	-	-	-	-	-
A04104	*	*	*	*	*	*	*	-	-	-	-	-	-	-	-	-
A04105	*	*	*	*	*	*	*	-	-	-	-	-	-	-	-	-
A04106	*	*	*	*	*	*	*	-	-	-	-	*	-	-	-	-
A04108	*	*	*	*	*	*	*	*	*	*	*	*	-	-	-	-
A04110	*	*	*	*	*	*	*	*	*	*	*	-	-	-	-	-
A04112	*	*	*	*	*	*	*	-	-	-	*	*	*	*	*	*
A04114	*	*	*	*	*	*	*	-	-	-	-	-	-	-	-	-
A04116	*	*	*	*	*	*	*	-	-	-	*	-	-	-	-	-
A04118	*	*	*	*	*	*	*	-	-	-	-	*	-	-	-	-
A04120	*	*	*	*	*	*	*	*	*	*	*	-	-	-	-	-
A04124	*	*	*	*	*	*	*	-	-	-	*	*	-	-	-	-
A04128	*	*	*	*	*	*	*	*	*	*	*	*	-	-	-	-
A04130	-	*	*	*	*	*	*	*	*	*	*	-	-	-	-	-
A04131	-	*	*	*	*	*	*	*	*	*	*	-	-	-	-	-
A04132	-	*	*	*	*	*	*	-	-	-	*	-	-	-	-	-
A04134	-	*	*	*	*	*	*	-	-	-	-	-	-	-	-	-
A04135	-	*	*	*	*	*	*	-	-	-	*	-	-	-	-	-
A04137	-	*	*	*	*	*	*	-	-	-	*	*	-	-	-	-
A04138	-	*	*	*	*	*	*	*	*	*	*	-	-	-	-	-
A04139	-	*	*	*	*	*	*	-	-	-	*	*	-	-	-	-
A04140	-	*	*	*	*	*	*	-	-	-	*	-	-	-	-	-
A04141	-	*	*	*	*	*	*	-	-	-	*	-	-	-	-	-
A04146	-	*	*	*	*	*	*	*	*	*	*	*	-	-	-	-
A04150	-	*	*	*	*	*	*	-	-	-	*	-	-	-	-	-
A04154	-	*	*	*	*	*	*	-	-	-	*	*	-	-	-	-
A04160	-	*	*	*	*	*	*	-	-	-	*	*	-	-	-	-
A04161	-	*	*	*	*	*	*	-	-	-	*	-	-	-	-	-
A04162	*	*	*	*	*	*	*	-	-	-	*	-	-	-	-	-
A04163	*	*	*	*	*	*	*	-	-	-	*	-	-	-	-	-
A04164	*	*	*	*	*	*	*	-	-	-	*	-	-	-	-	-
A04166	*	*	*	*	*	*	*	*	*	*	*	-	-	-	-	-
A04168	-	*	*	*	*	*	*	-	-	-	*	-	-	-	-	-
A04170	*	*	*	*	*	*	*	*	*	*	*	*	-	-	-	-
A04172	*	*	*	*	*	*	*	-	-	-	-	*	-	-	-	-
A04174	*	*	*	*	*	*	*	*	*	*	*	-	-	-	-	-
A04176	*	*	*	*	*	*	*	-	-	-	-	*	-	-	-	-
A04177	*	*	*	*	*	*	*	-	-	-	-	*	-	-	-	-
A04179	*	*	*	*	*	*	*	*	*	*	*	-	-	-	-	-
A04181	*	*	*	*	*	*	*	-	-	-	-	-	-	-	-	-
A04183	*	*	*	*	*	*	*	*	*	*	*	*	-	-	-	-

Station	Salinity	O2	PO4	SiO2	NO3	NO2	NH4	CFC-11	CFC-12	CFC-113	Alk	CHL A	CHL A GF/F-2	CHL A 2-5	CHL A 5-10	CHL A >10
A04185	*	*	*	*	*	*	*	-	-	-	-	*	-	-	-	-
A04192	*	*	*	*	*	*	*	*	*	*	*	*	-	-	-	-
A04193	*	*	*	*	*	*	*	*	*	*	*	*	-	-	-	-
A04194	-	*	*	*	*	*	*	*	*	*	*	*	-	-	-	-
A04196	*	*	*	*	*	*	*	-	-	-	*	-	-	-	-	-
A04198	*	*	*	*	*	*	*	-	-	-	*	-	-	-	-	-
A04201	-	*	*	*	*	*	*	-	-	-	*	*	-	-	-	-
A04203	-	*	*	*	*	*	*	-	-	-	*	-	-	-	-	-
A04205	-	*	*	*	*	*	*	-	-	-	*	*	-	-	-	-
A04206	-	*	*	*	*	*	*	-	-	-	*	*	-	-	-	-
A04207	-	*	*	*	*	*	*	*	*	*	*	*	*	*	*	*
A04208	-	-	-	-	-	-	-	-	-	-	-	-	-	-	-	-
A04210	-	*	*	*	*	*	*	-	-	-	*	-	-	-	-	-
A04211	-	*	*	*	*	*	*	-	-	-	*	-	-	-	-	-
A04212	-	*	*	*	*	*	*	-	-	-	*	-	-	-	-	-
A04213	-	*	*	*	*	*	*	-	-	-	*	-	-	-	-	-
A04214	-	*	*	*	*	*	*	-	-	-	*	-	-	-	-	-
A04215	-	*	*	*	*	*	*	-	-	-	*	-	-	-	-	-
A04216	-	*	*	*	*	*	*	-	-	-	*	-	-	-	-	-
A04217	-	*	*	*	*	*	*	-	-	-	*	-	-	-	-	-
A04218	-	*	*	*	*	*	*	-	-	-	*	-	-	-	-	-
A04219	-	*	*	*	*	*	*	*	*	*	*	-	-	-	-	-
A04220	-	*	*	*	*	*	*	-	-	-	*	-	-	-	-	-
A04221	-	*	*	*	*	*	*	-	-	-	*	-	-	-	-	-
A04222	-	*	*	*	*	*	*	-	-	-	*	-	-	-	-	-
A04224	-	*	*	*	*	*	*	-	-	-	*	-	-	-	-	-
A04228	-	*	*	*	*	*	*	-	-	-	-	-	-	-	-	-
A04229	-	*	*	*	*	*	*	-	-	-	-	-	-	-	-	-
A04230	-	*	*	*	*	*	*	-	-	-	-	-	-	-	-	-
A04231	-	*	*	*	*	*	*	-	-	-	-	-	-	-	-	-
A04232	-	*	*	*	*	*	*	-	-	-	-	-	-	-	-	-
A04233	-	*	*	*	*	*	*	-	-	-	-	-	-	-	-	-
A04234	-	*	*	*	*	*	*	-	-	-	-	-	-	-	-	-
A04235	-	*	*	*	*	*	*	-	-	-	*	-	-	-	-	-
A04236	-	*	*	*	*	*	*	-	-	-	*	-	-	-	-	-
A04237	-	*	*	*	*	*	*	-	-	-	-	-	-	-	-	-
A04238	-	*	*	*	*	*	*	-	-	-	-	-	-	-	-	-
A04239	-	*	*	*	*	*	*	-	-	-	-	-	-	-	-	-
A04240	-	*	*	*	*	*	*	-	-	-	*	-	-	-	-	-
A04241	-	*	*	*	*	*	*	-	-	-	-	-	-	-	-	-
A04242	-	*	*	*	*	*	*	-	-	-	*	-	-	-	-	-
A04243	-	*	*	*	*	*	*	-	-	-	-	-	-	-	-	-
A04244	-	*	*	*	*	*	*	-	-	-	-	-	-	-	-	-
A04245	-	*	*	*	*	*	*	-	-	-	-	-	-	-	-	-

3. Ocean Biology

3.1. Zooplankton survey

(1) Personnel

Sanae Chiba (FRCGC/JAMSTEC)

Bruno Jayme (University of Victoria, Canada)

Joanna Jenkins (IOS/DFO)

(2) Objective

The western Arctic Ocean holds a complex hydrographic structure, in which both Pacific-oriented and Atlantic-oriented waters enter and mix to affect biological distribution. It is also surrounded by broad continental shelves, and the ecosystem is subject to the influence of various physical events/conditions derived by shelf-basin interaction.

Two copepods species, *Calanus glacialis* and *C. hyperboreus* (Fig. 3.1-1), are widely distributed and dominate the zooplankton community over the Arctic Ocean. These species are the direct link between primary producers and the higher trophic level organisms such as fish and marine mammals in the Arctic Ocean food web. Not only that but also these species play an important role in the biological carbon pump by efficiently transporting particulated organic matters to the deep. The goals of this study are to investigate spatial variation in abundance, population structure and developmental timing of *C. glacialis* and *C. hyperboreus* in relation to the physical/chemical environments in the western Arctic Ocean, and to understand processes and possible ecological consequences of the observed variability. We conducted two research topics; 1. Variation of vertical distribution of *C. glacialis* and *C. hyperboreus* in relation to hydrographic environments, and 2. Regional variation in population structure of *C. glacialis* using mitochondrial DNA gene (16s rRNA).

(3) Sampling

Zooplankton were collected by vertical tow of a NORPAC net (mesh: 100 μm , mouth diameter: 45 cm) with closing system and a protected cod end (Fig. 3.1-2). Multiple layer tow was conducted at 4 stations: 5 layers between the surface and 500 m (0-50 m, 50-100 m, 100-200 m, 200-350 m, 350-500 m) at Sts. HC11, CHP and CAPE03, and 4 layers (0-50 m, 50-100 m, 100-200 m and 200-350 m) at St. HRC06 with a bottom depth shallower than 500 m (Fig. 3.1-3, Table 1) for vertical distribution study (1st topic). A single tow between the surface and 200 or 300 m was made at 9 stations including the multiple-layer tow stations for genetic study (2nd topic). A flow meter was installed on the net to estimate volume of the water filtered.

1. Variation of vertical distribution of *C. glacialis* and *C. hyperboreus* in relation to hydrographic environments (by S. Chiba)

Abundance, developmental stage composition and these vertical distribution patterns were regionally compared for both species. This information could indicate regional differences in reproductive timing and success of the copepods. Stable isotope ratio ($\delta^{13}\text{C}$, $\delta^{15}\text{N}$) of these species, which are indicatives of the regional trophic structure, are also to be measured to see if there are relationship between the copepods' reproductive conditions and trophic environment.

(4) Methods

Zooplankton collected were drained on the 100 μm mesh and stored in the -80°C deep freezer soon after sampling for later microscopic analysis. After thawing each sample, *C. glacialis* and *C. hyperboreus* were individually extracted and counted, and numerical abundance (ind m^{-3}) was estimated for every developmental stage (1st ~ 5th copepodite stage: CI~CV, adult female: F). No mature males were observed for both species. Some individuals (3~30) of CV were further picked up, dried under 60°C in a drying oven for 24 hr, and ground into powder for later $\delta^{13}\text{C}$ and $\delta^{15}\text{N}$ measurements.

(5) Preliminary Results (Fig. 3.1-4)

(Calanus glacialis)

Abundance was markedly high at Sts. CHP and HRC06, which are located in the shallower areas along the continental slope, compared to the Sts. HC11 and CAPE03. Relative abundance of younger stages (C1~CIII) was largest within the surface 50 m at all stations. Adult females appeared and CV dominated only at the St. CAPE03, suggesting that reproductive timing might differ from other stations. Majority of the population were concentrated within the upper 100 m.

(Calanus hyperboreus)

Abundance was higher at Sts. HRC06 and CAPE03, which are located in the western side of the research area. Younger stages dominated upper 100 m similar to *C. glacialis*, but relative and/or absolute abundance of advanced stages (CIV~F) increased in the deeper layers. There was the abundance-minimum-layer between the surface layer population and the deeper layer population, showing bi-modal distribution pattern of the population structure.

The distinctive distribution patterns observed for *C. glacialis* and *C. hyperboreus* might be attributed to the difference in their feeding and lifecycle strategy. Physical/chemical environments which might influence the observed distribution patterns will be examined

coupled with the results of $\delta^{13}\text{C}$ and $\delta^{15}\text{N}$ analysis.

2. Regional variation in population structure of *C. glacialis* using mitochondrial DNA gene (16s rRNA)(by B. Jayme)

In the Arctic Ocean, water from the North Atlantic and North Pacific join with Arctic water in a basin-wide circulation pattern modified by a variety of processes. This complex oceanographic structure may serve to produce ecologically distinct or hydrographically isolated ecosystems. Being circumpolar in distribution, *C. glacialis* has evolved to thrive in the heterogeneous Arctic Ocean and thus may consist of a collection of locally adapted sub-populations connected by varied levels of interbreeding. Using population genetics, the amount of interbreeding between different sub-populations can be estimated; this will reflect geographical isolation and life history differences which restrict gene flow.

16s rRNA, a large subunit of ribosomal RNA, has a sequence which varies sufficiently to discriminate closely related species. Our previous studies have revealed that *C. glacialis* in the Arctic Ocean have two different major haplotypes for 16s rRNA. One is found in the north Bering Sea and east of Bering Strait as far as Prudhoe Bay in the Arctic, and the second is found everywhere along the transect from Labrador to Bering Strait. Assuming that the *C. glacialis* from the north Bering Sea is being advected into the Arctic, questions are 1) how widely the “North Bering type” is dispersed in to the Arctic, and 2) how complicated water mass structure influences the geographical distribution of population structure of *C. glacialis*.

During the MR04-05 cruise, we collected *C. glacialis* from 10 stations including the two western most stations, MRE04 and MRW02 (Table 1), where no genetic analysis of this species has been made. Samples were drained on the 100 μm mesh and preserved in 95% ethanol soon after collections, from which *C. glacialis* was individually extracted and developmental stage was identified using a dissection microscope. After the cruise, DNA of those specimens will be extracted, a PCR will be run and the products were purified for sequencing. Incorporating data of this study to the previously obtained information, we expect to better understand geographical distribution of subpopulation of *C. glacialis* in the Arctic Ocean.

Table 3.1-1 Information of NORPAC net sampling

sampling No	Date	CTDsta	stationID	time start (LST)	time end (LST)	time start (UTC)	time end (UTC)	Lat (N)	Long (W)	tow type	sample ID	sampled layer (m)	water vol. filt'd (m ³)	remark
1	2004.09.05	Sta. 009	CHK0404					70° 38'	166° 45'	single layer	null	30-5	null	test
2	2004.09.05	Sta. 011	CHK0405					70° 38'	168° 15'	single layer	null	30-5	null	test
3	2004.09.07	Sta. 024	HC11	1514	1815	2314	215	74° 03'	158° 03'	5 layers x 2	HC11-1	500-350	36.5	double sampling
											HC11-2	350-200	18.5	
											HC11-3	200-100	11.6	
											HC11-4	100-0	11.7	0-100 due to releaser problem
											HC11-5	50-0	11.5	double sampling
4	2004.09.08	Sta. 025	CHP	1039	1218	1839	2018	74° 24'	162° 09'	5 layers	CHP-1	500-350	22.2	
											CHP-2	350-200	20.1	
											CHP-3	200-100	15.5	
											CHP-4	100-50	6.7	
											CHP-5	50-0	7.8	
										single layer	CHP(S)	200-0	34.9	
5	2004.9.9	Sta. 035	HRC06	1155	1300	1955	2100	75° 00'	172° 00'	4 layers	HRC06-1	350-200	12.0	
											HRC06-2	200-100	9.4	
											HRC06-3	100-50	4.4	
											HRC06-4	50-0	4.3	
										single layer	HRC06(S)	200-0	17.5	
6	2004.9.11	Sta. 047	MRE04	1155	1225	1955	2025	75° 27'	177° 05'	single layer	MRE04	300-0	42.9	
7	2004.9.12	Sta. 049	MRW03	1103	1125	1903	1925	75° 47'	179° 04'	single layer	MRW03	300-0	43.4	
8	2004.9.13	Sta. 059	CAPE03	1533	1720	2333	120	75° 39'	170° 25'	5 layers	CAPE03-1	500-350	16.1	
											CAPE03-2	350-200	16.0	
											CAPE03-3	200-100	10.8	
											CAPE03-4	100-50	5.5	
											CAPE03-5	50-0	5.5	
										single layer	CAPE03(S)	200-0	21.7	
9	2004.9.21	Sta. 112		1005	1025	1805	1825	74° 00'	152° 00'	single layer	CB05	300-0	28.7	
10	2004.10.4	Sta. 207		1300	1321	2100	2121	71° 06'	159° 02'	single layer	Sta. 207	70-0	8.9	cod end fell off
										single layer	Sta. 207	70-0	8.7	
										single layer	Sta. 207	70-0	8.5	

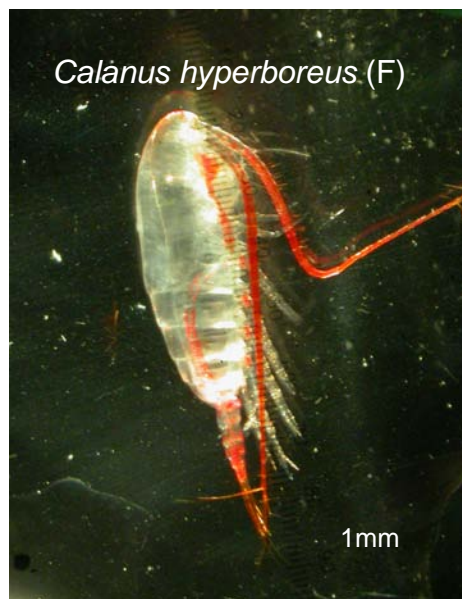

Fig. 3.1-1 Arctic copepods: *Calanus glacialis* (CV) and *Calanus hyperboreus* (F)



Fig. 3.1-2 NORPAC net with closing system

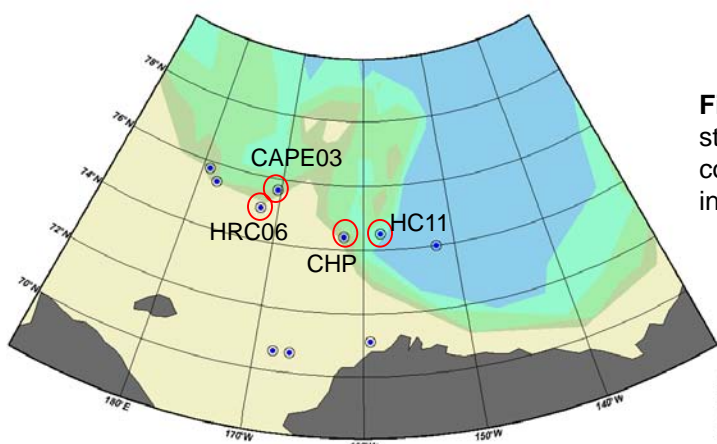

Fig. 3.1-3 Zooplankton sampling stations. Multiple-layer-tow was conducted at the 4 stations indicated by red circles.

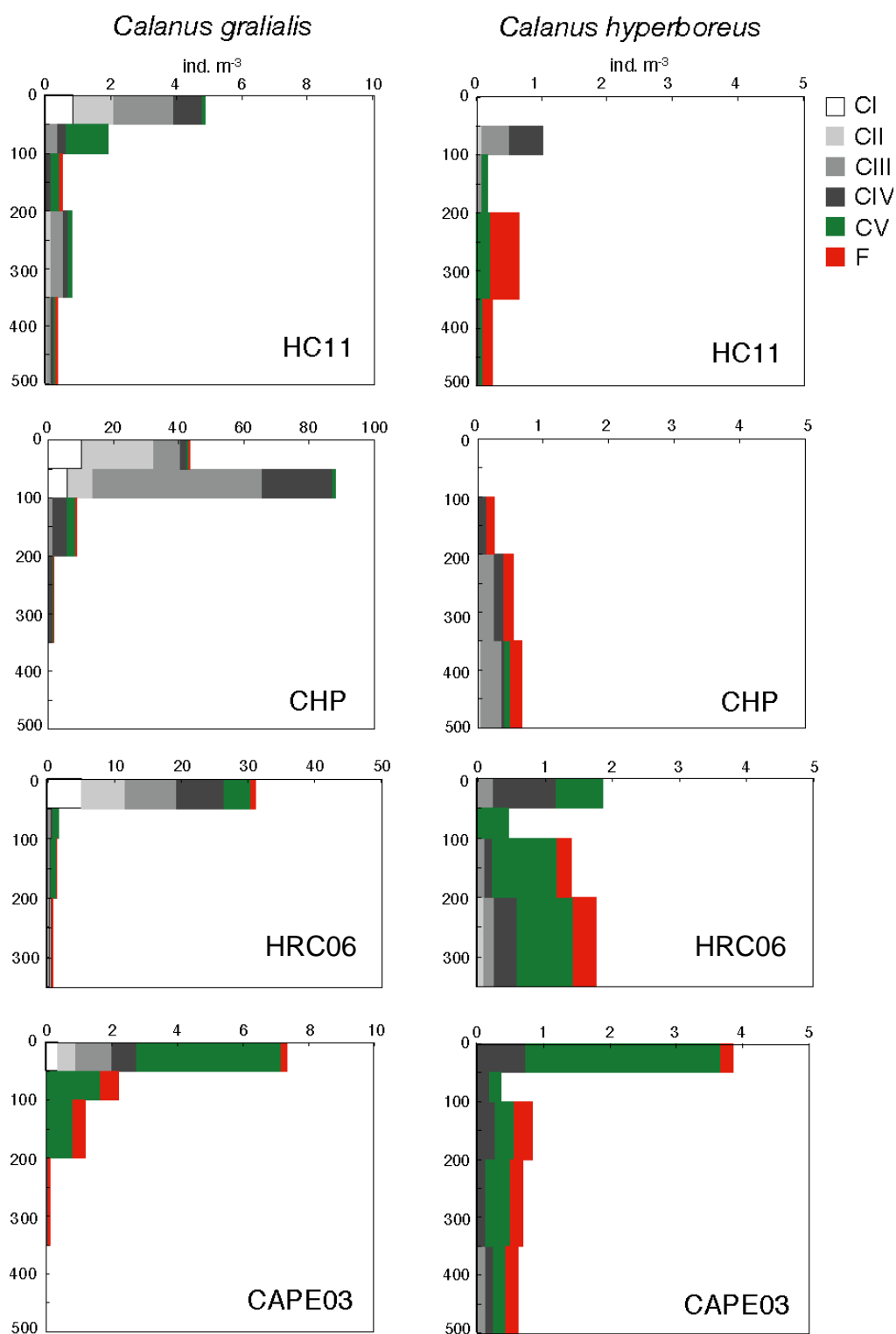

Fig. 3.1-4 Vertical distribution (ind m⁻³) of *Calanus gracialis* and *Calanus hyperboreus* at 4 stations, HC11, CHP, HRC06 and CAPE03. Developmental stage compositions (5 copepodite stages: CI-CV and mature female: F) are shown.

3.2. Population structure study of *Calanus glacialis* using the mitochondrial DNA gene (16srRNA).

(1) Personnel

Dr. R. John Nelson and Bruno Jayme. University of Victoria, British Columbia Canada.

(2) Preliminary results

In the Arctic Ocean, water from the North Atlantic and North Pacific oceans join with Arctic water in a basin-wide circulation pattern which is modified by a variety of process. This result in large and small scale oceanographic structuring both of which may serve to produce ecologically distinct or hydrographically isolated ecosystems. The marine zooplankton, *Calanus glacialis*, is found throughout the Arctic Ocean and the North Bering Sea and is an important food source for many species. Being circumpolar in distribution, *C. glacialis* has evolved to thrive in the heterogeneous Arctic Ocean and thus may consist of a collection of locally adapted sub-populations connected by varied levels of interbreeding. Using population genetic, the amount of interbreeding between different sub-populations can be estimated; this will reflect geographical isolation and life history differences which restricts geneflow. By studying the population genetics of *C. glacialis* in concert with oceanographic measurements, we can identify which hydrographic features that creates functionally different ecosystems. This understanding will provide a foundation for understanding the linkages between physical and ecological parameters in the Arctic.

Research Vessel Mirai was used as a platform to collect *Calanus glacialis* for subsequent genetic analysis. Mixed zooplankton samples were collected using vertical tow (bongo net), with 100µm mesh size (see Table 1. below). On board the ship, the samples were stored in 95 % ethanol and sorted into different species prior to being shipped to University of Victoria for genetic analysis. The 16S ribosomal RNA gene was sequenced for *C. glacialis* samples collected from stations, HC11; HRC6; MRE4; MRW3; and CAPE3. The results of this genetic analysis is shown in Figure 1. This data will be combined with data regarding the genetics of other *C. glacialis* collected during other research cruises beginning in 2000, to determine the degree of population structuring. This information will be interpreted in concert with oceanographic data and geological development of the regions from which samples were collected.

Table 3.2-1.

Mixed zooplankton samples collected from R/V Mirai for genetic analysis.

station	Lat	Long	Date	Depth	Time
CHP	74° 399	197° 843	9/4/2004	200	10:39
CHK4	70° 633	193° 25	9/5/2004	35	8:00
HC11	74° 29.653	158° 2.522	9/7/2004	100	15:14
HRC6	75° 000	172° 000	9/9/2004	200	11:55
MRE4	75° 451	183° 167	9/11/2004	331	11:55
MRW3	75° 958	179° 917	9/12/2004	300	11:03
CAPE3	75° 653	189° 58	9/13/2004	200	15:30
CB05	74° 00	208° 00	9/21/2004	300	10:00

Fig. 3.2-1. Genetic profile of 16S ribosomal RNA gene of *Calanus glacialis*.

Different design within each pie chart indicate relative frequencies of different haplotype of *C. glacialis* collected at station at position of pie chart on the map.

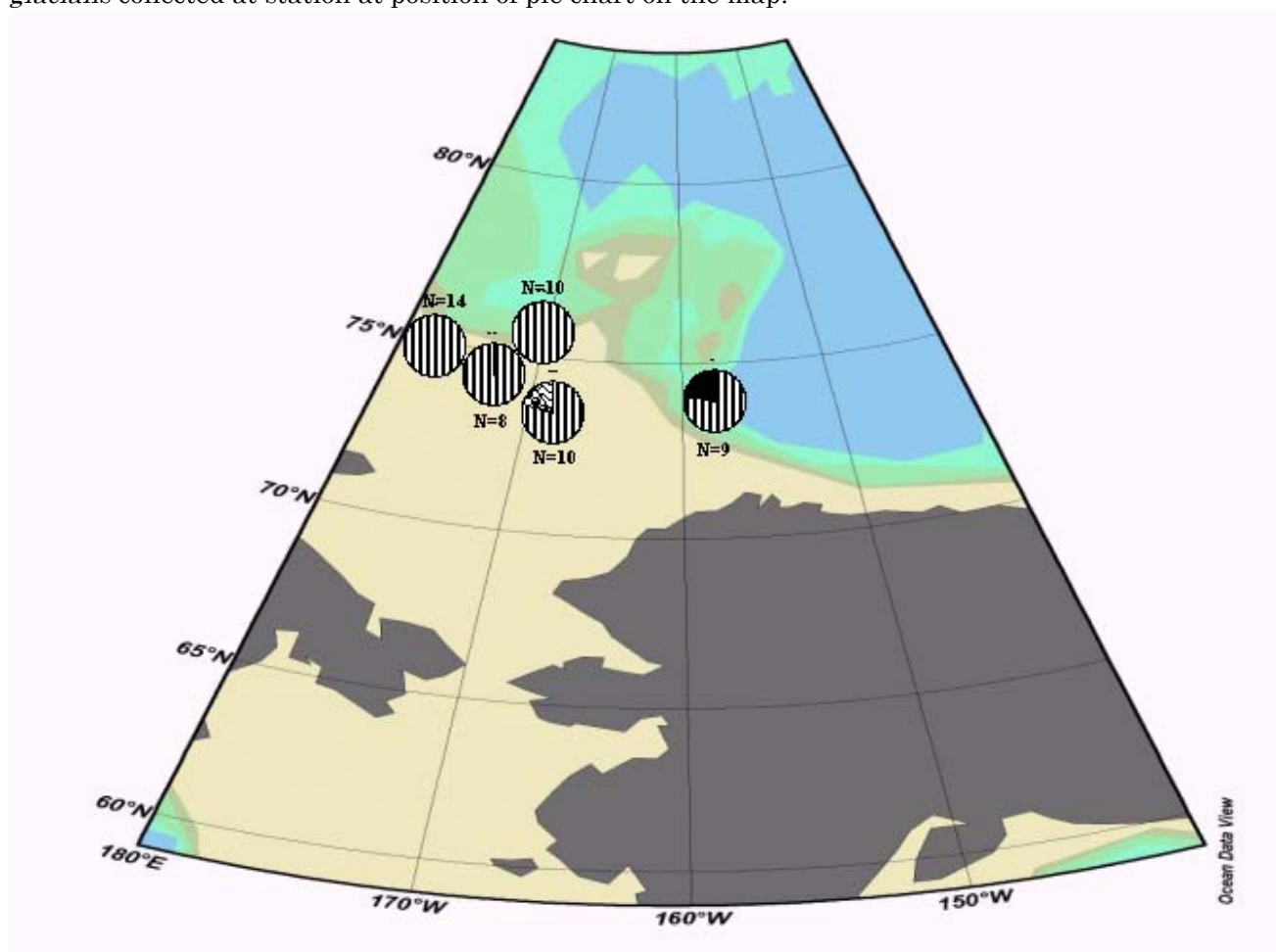

3.3. Bio-optical Observation

(1) Personnel:

Atsushi Matsuoka, Sei-ichi Saitoh
Satellite Oceanography Group, Hokkaido University

(2) Background

In the Western Arctic regions, there are very high productive areas, some coastal areas and polynyas, comparing to other regions. For example, peak production on the Chukchi shelf is estimated to be $2.4 \text{ g C m}^{-2} \text{ d}^{-1}$ (Chen *et al.*, 2002). In addition, productivity of NEW polynya appears to be peaking at $1.1 \text{ g C m}^{-2} \text{ d}^{-1}$ (Smith, 1995), similar to values measured in the Barents Sea (Luchetta *et al.*, 2000). In this way, while high primary production has been estimated in some areas by ship observations, they have spatial and temporal variability. We never know the present conditions whenever we would like to know. Also, because the data is based on field measurements, field work is often limited by sea ice conditions with periods and areas. This means that those data can have some problems: The observation data in the Arctic regions has been taken during navigable seasons, which means data has some bias. Moreover those data were from icebreaker in ice-covered waters, or from around buoy-deployed areas where phytoplankton blooms is very high rather than other regions. It is necessary that observations should be conducted with wide range at a time and be continued for long time for equilibrium evaluation. At this point, high resolution ocean color sensors do have advantage. Even if we can never arrive at some areas, we can know what's going on there using satellite. Therefore, we need to develop OCA to understand variability of phytoplankton with high spatial and temporal resolution continuously, which in turn leads to understand the Arctic carbon cycle.

Here, present OCA has a big problem. It is that almost all data has been came from CalCOFI cruise, a limited data set (O'Reilly *et al.*, 1998; O'Reilly *et al.*, 2000), so the value of chlorophyll *a* concentration in the some Arctic regions are much different, compared to field measurements. This means that we need to develop a new algorithm for the Arctic, so-called, the Arctic version OCA. In fact, for that, the bio-optical observations were already conducted in the Arctic areas to develop OCA (Wang and Cota, 2003; Cota, Wang, and Comiso, 2004). However, stations of observations were not considered for CASE 2 Water that optical properties are prevailed by non-pigment particles and dissolved matter but for convenient based on latitude-longitude positions. It's should be a big problem for development of OCA because phytoplankton is very sensitive to physical phenomena. Fortunately, in this time, I took data from this cruise, MR04-05, where

oceanic current and topography has very high positive correlation (Shimada *et al.*, 2005). We're expecting that we can find the high relationship between such a physical phenomena and biological activities, like a 'Pacific Pastures' as Eddy Carmack suggests, for a new Arctic version OCA.

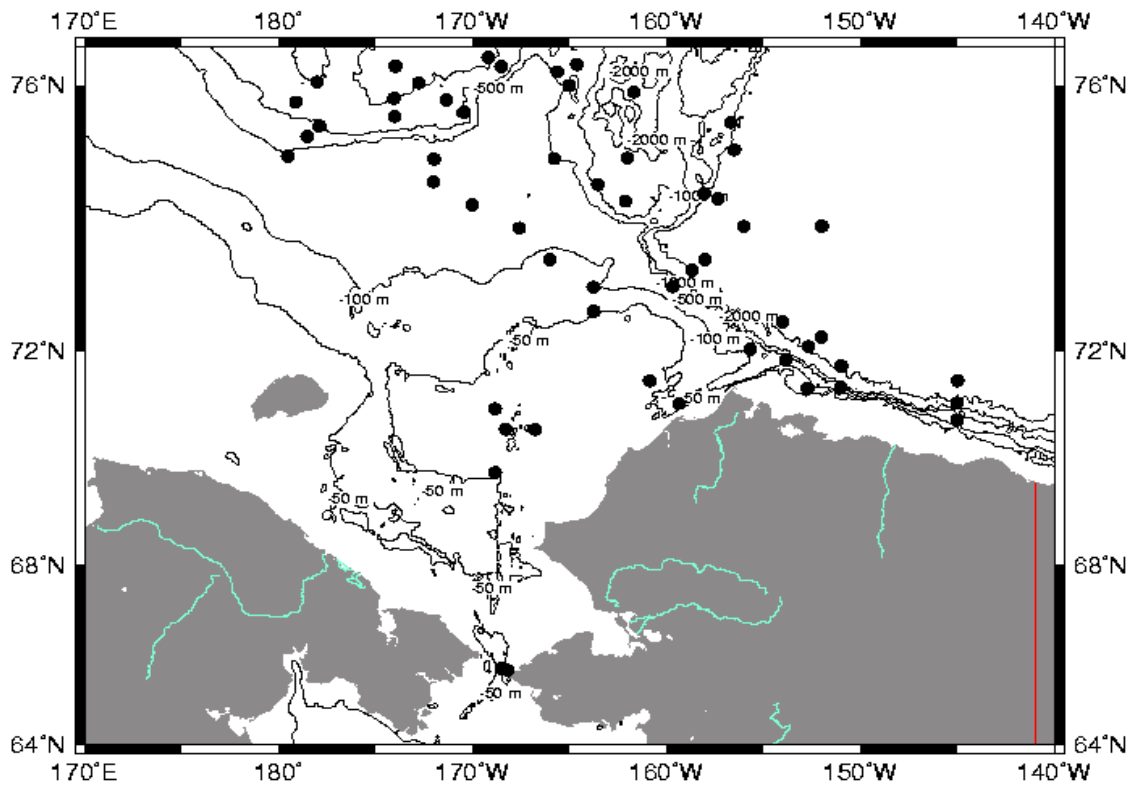

Fig. 3.3-1. Sampling stations for study area. Circle shows water sampling and stars inside the circles show PRR 600 spectral radiometer measured stations

(3) Objectives

Here, we present some results from bio-optical properties, leading to the objectives listed below.

- 1) To understand the bio-optical properties in the Western Arctic Sea
- 2) To understand the relationship between bio-optical properties and surrounding physical features such as coastal or riverine areas
- 3) To develop OCA for the whole Arctic regions based on the concept listed above

(4) Data and Methods

(4-1) Sampling Information

Bio-optical observations were made on board the R/V Mirai from September 1st to October 12th in the Western Arctic regions ranged from approximately 64-76° N, 145-180° W. The number of water sampling stations is 55, and 30 of them are bio-optical observed stations.

(4-2) Data and Analysis

Discrete water samplings were collected for chlorophyll *a* concentrations and absorption analysis over the euphotic zone, the depth is approximately 70m. All particulate collections were made on Whatman 0.77 μ m glass fiber filters. We measured absorption of total suspended particulate (a_p) using Multi-purpose Spectrophotometer (MPS2400) produced by Shimadzu corporation. After that, we extracted absorption of non-chlorophyll particles coefficient, using methanol according to Kishino *et al.*, 1995. We determined absorption coefficient of non-pigment particles (a_d) subtracting that of phytoplankton (a_{phy}) from a_p . For a_{phy} , we use QFT (Quantitative Filter Technique) and the coefficient suggested by Cleveland and Weidemann, 1993 for the algorithm are adapted. Normalized at 750nm, we obtained a_{phy} and a_d , respectively. For absorption of Colored Dissolved Organic Matter (CDOM), water samples were made on Millipor 0.22 μ m sized filter. We then obtained absorption of CDOM by MPS2400 with photomultiplier unit, normalized at 700nm. Backscattering coefficients $bb(\lambda)$ were calculated the model of Reynolds *et al.*, 2001.

a. Chlorophyll and Optical properties

Chlorophyll *a* concentrations (Chl*a*) were measured with Turner design fluorometer by standard fluorometric methodology.

b. In-water Reflectance Measurements

Downwelling spectral irradiance $E_d(\lambda)$ and upwelling radiance $L_u(\lambda)$ measurements were made with a Biospherical Instruments Inc. Profiling Reflectance Radiometer (PRR600/610) which has the center channels, 412nm, 443nm, 490nm, 520nm, 565nm, and 670nm. It is necessary to interpolate 510nm and 555nm to apply for SeaWiFS and MODIS because 6 bands listed above are consistent with Ocean Color and Temperature Scanner (OCTS). It is possible to do that using $a(\lambda)$ & $bb(\lambda)$ combined R_{rs} , showing the good correlation between them.

The instrument includes tilt-and roll sensors, and tilt of $<5^\circ$ was considered available (Wang and Cota, 2003). In this time, we use maximum tilt angle of approximately 10° to determine available limit angle. Under this concept, we obtained

upwelling radiance just below the surface, $L_u(\lambda, -0)$ with least square fitting based on the depths from 1 to 5 m where $L_u(\lambda)$ are considered available.

(4-3) Above-water Reflectance Measurements

During our cruise to the Chukchi Sea, RAMSES hyperspectral radiance and irradiance sensors were mounted on the middle of the ship where height was approximately 10 meters from the sea surface. The height was considered to avoid ship shadow and wake bubbles. Briefly, multiple spectra of above-surface upwelling radiance (L_u) and downwelling sky radiance (L_d) were collected during our cruise and set at 30° from nadir and L_d was measured at 30° from zenith, and solar irradiance sensor was set to vertical direction. All instruments are measured from 350nm to 1000nm by 1nm. In this report, this analysis aren't mentioned.

(5) Results

The relationship between Inherent Optical Properties and Apparent Optical Properties

The comparison R_{rs} from $a(\lambda)$ & $b_b(\lambda)$ and PRR600 are illustrated in Fig. 3.3-2. Two-band-ratios R_{rs} from above water are highly correlated to in-water observations. Linear regression between these two ratios shows a slope of 0.85 over and a determination coefficient of 0.95 ($p < 0.0001$). These high correlations indicate that AOPs (Apparent Optical Properties) from PRR600 are useful for expression of IOPs (Inherent Optical Properties) from water samples statistically. Note that the values of R_{rs} ratio from PRR in some stations are far from $a(\lambda)$ & $b_b(\lambda)$ although these stations aren't typical coastal area nor mouth of rivers, which means a_{ph} , a_d , and a_g aren't typical, compared to other regions. It is necessary that hydrographic environment should be considered with bio-optical features.

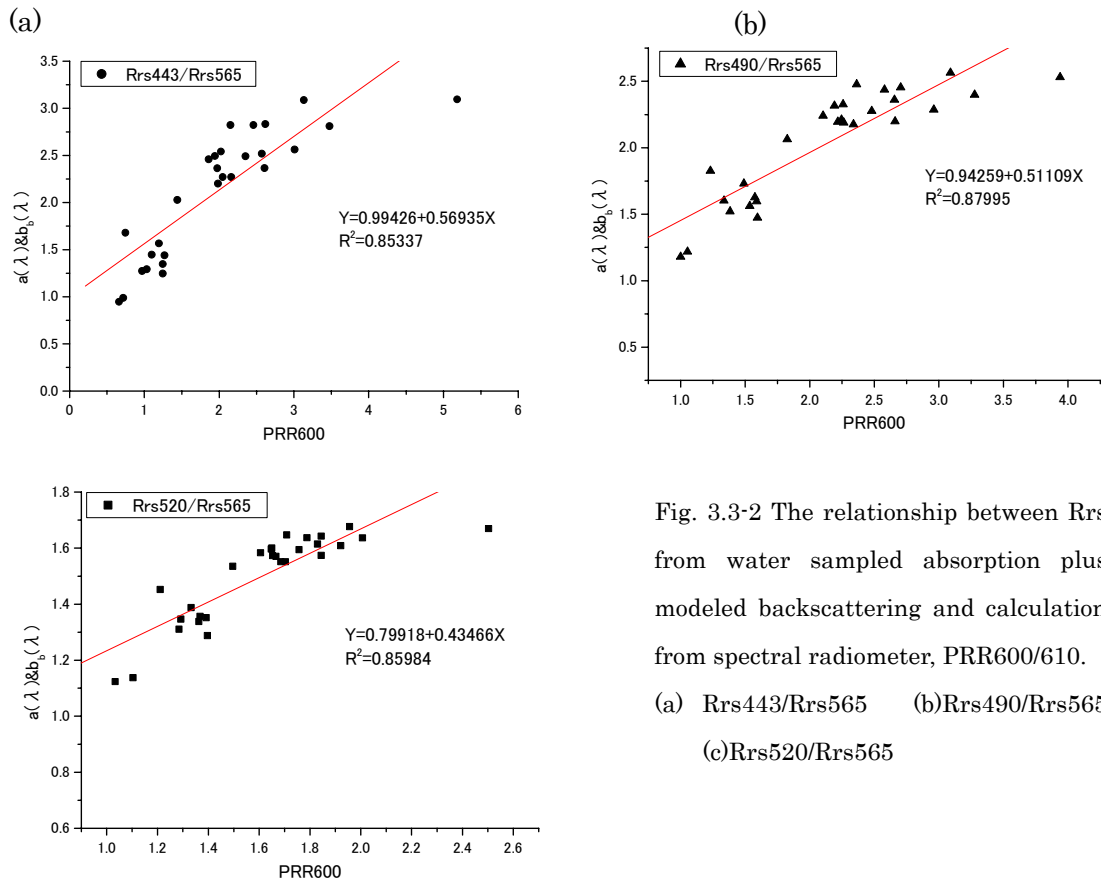

Fig. 3.3-2 The relationship between Rrs from water sampled absorption plus modeled backscattering and calculation from spectral radiometer, PRR600/610.
 (a) Rrs443/Rrs565 (b) Rrs490/Rrs565
 (c) Rrs520/Rrs565

To examine the relative relationship among each constituent of absorption, schematic diagram are illustrated in Fig. 3.3-3. Sampling stations are classified to CASE 2 water that optical properties are prevailed by not phytoplankton but non-pigment suspended material and dissolved organic matter according to Prieur and Sathyendranath, 1981 and Sathyendranath, 2000. One of significant features is that a_g is independent on a_{phy} and a_d in almost all stations except coastal and mouth of rivers regions. It is necessary that the magnitude of each constituent is also considered to classify water type in terms of bio-optics. This leads to be fundamental trial to develop OCA in the Arctic regions in terms of Remote Sensing Reflectance (Rrs).

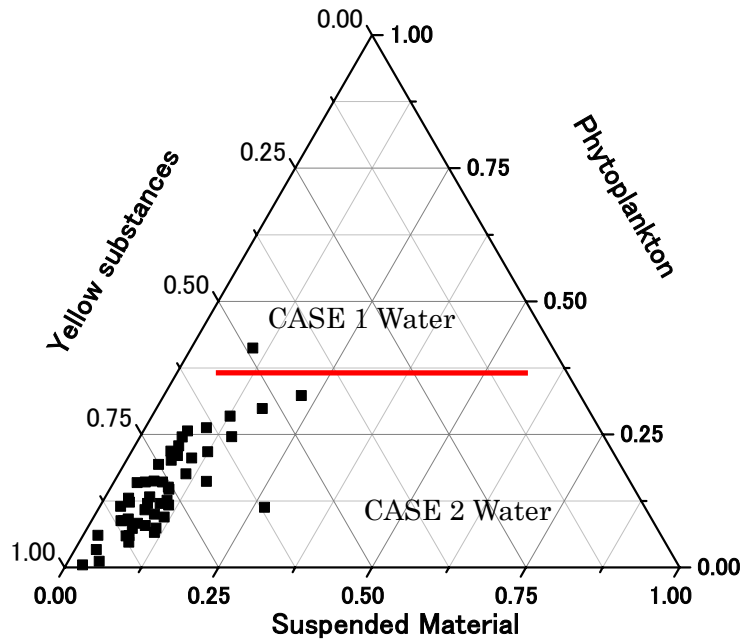

Fig. 3.3-3 An illustration of the triangular diagram in use to classify waters for CASE 1 and 2 water based on Prieur and Sathyendranath, 1981

(6) Expected Results

We hope that our results reveal the relationship between bio-optics and physical oceanography, and then suggest the new Arctic OCA to apply for WHOLE Arctic regions. This leads to reveal global carbon cycle, which in turn to link to the issue of global warming caused by carbon dioxide increase. In the near future, our results contribute to research the Arctic climate change with respect to biological productivities. It should be one approach to understand Arctic climate systems with another view.

4. Barium

(1) Personnel

Hisashi Narita (Hokkaido University)

(2) Objectives

Barium concentration provides information complementary to oxygen isotope for determining the origin of brines ventilating cold halocline water. In this study, to understand mechanisms of redistribution of riverine water, Pacific originated water and brines will be analyzed for barium concentration in key regions of the Arctic Ocean and surrounding sea, and determine with data of nutrients, oxygen and its isotopes.

(3) Sampling

2662 seawater samples for barium analysis were collected at hydrographic observation stations using X-Niskin bottles mounted on the CTD/CWS system, respectively. In addition, 271 surface waters for barium analysis were also collected in the Sea Surface Water Monitoring during this cruise. The samples for barium analysis were collected into 10 ml acid cleaned polyethylene vials after pre-rinsing with the sample. The external joints between caps and bodies were wrapped in Parafilm to minimize evaporation, and the unacidified samples were enclosed in plastic bags for storage. All samples were stored at room temperature until analysis in Tokai University. Chlorophyll *a* and POC samples were also collected to understand removal processes of barium from surface water and lateral advection of water masses from shelf area to oceanic basin. The filtrated samples for Chlorophyll *a* and POC were kept in a freezer until the measurements.

(4) Analytical method

Barium concentrations will be determined by isotope dilution-inductively coupled plasma quadrupole mass spectrometry (ID-ICPMS) in a manner similar to that described by Klinkhanner and Chen (1990). Briefly, 1 ml of seawater sample was spiked with an equal volume of ^{135}Ba -enriched solution (Oak Ridge National laboratories) and diluted 100-fold in 0.16 N ultra pure HNO_3 . Samples were introduced into ICP-MS.

(5) Expected Results and future works

The results will indicate possibilities for barium as a water mass tracer in the Arctic Ocean. The source of barium into the Arctic is important not only Mackenzie River but also Yukon River. Because barium concentration is affected with both biological removal in the surface water and regeneration in the sediment-water interface, the source water of Bering Sea is more important as potential source of barium in the Arctic Ocean compared with Mackenzie riverine water.

In future, we will discuss the biogeochemical processes in the Bering Sea and Arctic Ocean from chlorophyll *a*, phytoplankton species composition and POC data including nutrients and oxygen data.

5. carbon-13, oxygen-18, dissolved inorganic carbon, and methane

Together with Shigeto Nishino and colleagues from JAMSTEC and Japan Marine works, Jo Jenkins from Fisheries and Oceans Canada collected water column samples for carbon-13, oxygen-18, dissolved inorganic carbon, and methane analyses. Table 1 provides a summary of the number and type of samples collected at each station. Samples for ^{13}C analysis were collected to investigate the atmosphere-ocean disequilibrium and C.S. Wong is the principal investigator. Samples for ^{18}O analysis were collected to determine the contributions of ice melt and river inflow in the upper 250 m of the water column. Principal investigators are Michiyo Kawai, Fiona McLaughlin and Eddy Carmack. Samples for dissolved inorganic carbon were collected at 4 stations to investigate the sequestration of carbon in the water column and Fiona McLaughlin is the principal investigator. Samples for methane analysis were collected, one per station at ~ 10 m above the sea floor, to investigate the release of methane from sediment. Principal investigators are Fiona McLaughlin and Scott Dallimore from National Resources Canada. All samples are undergoing analysis, either at IOS laboratory or at IARC (^{18}O) and there are no data at this date.

Table 5-1 Sample Summary

CTD Station name	Station name	Number of bottles sampled			
		^{13}C (5m)	DIC	CH_4	^{18}O
A04006	HV	2	0	0	0
A04007	CC00	2	0	0	0
A04009	CC02	2	0	0	0
A04011	CC04	2	0	2	0
A04015	HC00	2	0	0	0
A04016	HC01	2	0	1	0
A04017	HC02	2	0	0	0
A04018	HC03	2	25	2	14
A04019	HC05	2	0	2	15
A04020	HC06	2	0	2	15
A04021	HC07	2	34	2	15
A04022	HC10	0	0	0	15
A04023	HC11	2	0	2	15
A04029	HRC01	1	0	2	11
A04031	HRC03	1	0	2	14
A04035	HRC06	1	0	2	14
A04036	HRC08	1	0	2	14
A04040	CAPW01	1	0	2	14
A04041	CAPW02	1	0	2	14
A04042	CAPW03	1	0	2	15
A04043	CAPW04	1	0	2	15
A04044	CAPW05	1	0	1	15
A04045	CAPW06	1	0	2	15
A04046	MRE01	1	0	0	0
A04047	MRE02	1	0	2	0
A04048	MRE03	1	0	2	15
A04049	MRE04	1	0	2	15
A04050	MRE05	1	0	2	14

Table 5-1 Sample Summary

CTD Station name	Station name	Number of bottles sampled			
		¹³ C (5m)	DIC	CH ₄	¹⁸ O
A04053	MRE06	1	0	0	0
A04051	MRE08	1	0	0	14
A04052	MRW01	1	0	2	14
A04055	MRW03	1	0	2	15
A04056	MRW04	0	0	0	14
?	MCAP01	1	0	0	15
A04057	CAPE01	1	0	2	15
A04058	CAPE02	1	32	2	15
A04059	CAPE03	1	0	2	0
A04060	CAPE05	1	0	2	0
A04061	CAPE04	1	0	2	0
A04062	GAPE1	1	0	2	14
A04063	GAPE2	1	0	2	14
A04072	CHKB08	1	0	2	7
A04073	CHKB09	1	0	2	7
A04074	CHKB10	1	0	0	0
A04075	CHKB11	1	0	2	0
A04076	CHKB12	1	0	2	11
A04078	CHKB14	1	0	2	10
A04079	CHKB15	1	0	2	11
A04080	CGAPW1	0	0	2	15
A04081	CGAPSE1	1	0	2	14
A04082	CGAPSE2	1	0	2	14
A04083	CGAPE2	1	0	2	14
A04085	CGAPE4	1	0	2	14
A04088	CGAPS2	1	0	0	0
A04089	CGAPW2	1	0	2	14
A04090	CGAPW4	1	0	2	15
A04091	CGAPW5	1	0	2	15
A04098	NAPC1	29	30	2	29
A04105	NWRN-E3	1	0	2	15
A04106	NWRN-E1	1	0	2	15
A04110	CBN3	1	0	2	15
A04112	CBN5	1	0	2	15
A04114	CBC07	1	0	2	15
A04116	CBC09	1	0	2	15
A04118	CBC11	1	0	2	15
A04124	NAPC2	1	0	2	15
A04132	SCAN4	1	0	2	14
A04146	CS250-09	1	0	2	13
A04154	CS250-17	1	0	2	11
A04160	CS250-18	1	0	2	11
A04166	CS800-5	1	0	2	15
A04177	CS2000-11	1	0	2	15
A04181	CS2000-7	1	0	2	15
A04183	CS2000-5	1	0	2	15
Total samples	Total samples	112	121	120	823

6. Underway geophysical observations

6.1. Swath bathymetry

(1) Personnel

Koji SHIMADA (JAMSTEC) Principal investigator
Souichiro SUEYOSHI (Global Ocean Development Inc. GODI)
Shinya OKUMURA (GODI)
Katsuhisa MAENO (GODI)
Kazuho YOSHIDA (GODI)
Not on-board:
Toshiya Fujiwara (JAMSTEC): Principal investigator

(2) Introduction

R/V MIRAI equipped a Multi Narrow Beam Echo Sounding system (MNBES), SEABEAM 2112.004 (SeaBeam Instruments Inc.) The main objective of MNBES survey is collecting continuous bathymetry data along ship's track to make a contribution to geological and geophysical investigations and global datasets. We had carried out bathymetric survey during the MR04-05 cruise from Dutch Harbor, USA on 01 September 2004 to Dutch Harbor, USA on 12 October 2004.

(3) Data Acquisition

The "SEABEAM 2100" on R/V MIRAI was used for bathymetry mapping during this cruise. To get accurate sound velocity of water column for ray-path correction of acoustic multibeam, we used Surface Sound Velocimeter (SSV) data at the surface (6.2m) sound velocity, and the others depth sound velocity calculated temperature and salinity profiles from CTD data by the equation in Mackenzie (1981) during this cruise.

System configuration and performance of SEABEAM 2112.004,

Frequency: 12 kHz

Transmit beam width: 2 degree

Transmit power: 20 kW

Transmit pulse length: 3 to 20 msec.

Depth range: 100 to 11,000 m

Beam spacing: 1 degree athwart ship

Swath width: 150 degree (max)

120 degree to 4,500 m

100 degree to 6,000 m

90 degree to 11,000 m

Depth accuracy: Within $< 0.5\%$ of depth or $\pm 1\text{m}$, whichever is greater, over the entire swath.

(Nadir beam has greater accuracy; typically within $< 0.2\%$ of depth or $\pm 1\text{m}$, whichever is greater)

(4) Preliminary Results

The results will be published after primary processing.

(5) Data Archives

Bathymetry data obtained during this cruise will be submitted to the JAMSTEC Data Management Division, and archived there.

6.2. Sea Surface Gravity

(1) Personnel

Souichiro SUEYOSHI (Global Ocean Development Inc. GODI)
 Shinya OKUMURA (GODI)
 Katsuhisa MAENO (GODI)
 Kazuho YOSHIDA (GODI)
 Not on-board:
 Toshiya Fujiwara (JAMSTEC): Principal investigator

(2) Introduction

The difference of local gravity is an important parameter in geophysics and geodesy. We collected gravity data at the sea surface during the MR04-05 cruise from Dutch Harbor, USA on 01 September 2004 to Dutch Harbor, USA on 12 October 2004.

(3) Parameters

Relative Gravity [mGal]

(4) Data Acquisition

We have measured relative gravity using LaCoste and Romberg air-sea gravity meter S-116 (LaCosat and Romberg Gravity Meters, Inc.) during this cruise. To convert the relative gravity to absolute one, we measured gravity, using portable gravity meter (Scintrex gravity meter CG-3M), at Dutch Harbor as reference points.

(5) Preliminary Results

Absolute gravity shown in Tabel -1

Table -6.2-1

No.	Date	UTC	Port	Absolute Gravity (mGal)	Sea Level (cm)	Draft (cm)	Gravity at Sensor (mGal)	L&R (mGal)
1	2004/Aug/31	17:22	Dutch Harbor	-	360	657	-	13839.6
3	2004/Oct/13	20:32	Dutch Harbor	981527.61	380	630	981528.83	13837.8

*1: Gravity at Sensor= Absolute Gravity + Sea Level*0.3086/100 + (Draft-530)/100*0.0431

*2: LaCoste and Romberg air-sea gravity meter S-116

(6) Data Archives

Gravity data obtained during this cruise will be submitted to the JAMSTEC Data Management Division, and archived there.

7. Meteorological observation

7.1. Cloud Science study over the Arctic Sea

(1) Personnel

On board

Yasushi Fujiyoshi	(FRCGC/Inst. Low Temp. Sci., Hokkaido Univ., Japan)
Souichiro Sueyoshi	(GODI, Japan)
Shinya Okumura	(GODI, Japan)
Katsuhisa Maeno	(GODI, Japan)
Kazuho Yoshida	(GODI, Japan)

Co-workers not on board

Nobuo Sugimoto, Ichiro Matsui, Atsushi Shimizu (National Institute for Environmental Studies, Japan)
Toshiaki Takano (Chiba University, Japan)

(2) Objective

The purpose of this study is to study “atmosphere-ocean-aerosol-cloud” coupling in the Arctic Ocean. A focus on polar clouds is motivated by poor understanding of the physical processes at work in the polar cloud boundary layer, and poor simulation of polar cloud, radiation, and boundary layer models by current climate models.

(3) Instruments, methods and measured parameters

(3-1) Radiosonde

Radiosonde observations were carried out from 04 September to 07 October 2004, by using GPS radiosonde (RS92-SGP, RS80-GH). We used DigiCORA III (MW21), GPS antenna (GA20), UHF antenna (RB21) and balloon launcher (ASAP) made by Vaisala. Prior to launch, humidity, air temperature, and pressure sensors were calibrated by using the calibrator system (GC25, Vaisala). Measured parameters are temperature (°C), relative humidity (%), wind direction (deg), wind speed (m/s), air pressure (hPa). Table 1 summarizes the log of upper air soundings. All data were sent to the world meteorological community by the global telecommunication system (GTS) through the Japan Meteorological Agency soon after each observation. Ascii data was converted from raw binary data that were automatically recorded during operation.

Table 7.1- 1 Launch

No.	DATE & TIME				Position		Surface Data					Maximum Altitude		Cloud Amount & type	
					Lon. E	Lat. N	P	T	RH	WD	WS	(hPa)	(gpm)		
	YY	MM	DD	HH	(deg.)	(deg.)	(hPa)	(°C)	(%)	(deg.)	(m/s)	(hPa)	(gpm)		
RS-002	04	09	04	12	-168.813	68.0108	1017.2	4.4	81	320	2.2	56.6	19892	8	Unknown
RS-003	04	09	05	00	-167.163	70.3556	1019.0	4.4	68	226	0.8	41.4	21914	8	Ac, Sc
RS-004	04	09	05	12	-166.211	70.6298	1020.0	4.9	76	77	3.1	41.6	21871	10	Ac, Sc
RS-005	04	09	06	00	-168.467	71.4898	1018.8	6.9	70	195	9.7	37.5	22559	9	Sc, As
RS-006	04	09	06	12	-165.683	72.9304	1015.3	3.7	100	190	11.8	35.8	22839	9	As, Sc
RS-008	04	09	07	12	-157.903	73.9598	1013.3	1.6	100	251	7.0	45.2	21319	10	Sc, St
RS-009	04	09	08	00	-158.065	74.4912	1014.8	0.6	95	337	4.6	37.2	22560	10	As, Sc
RS-010	04	09	08	12	-159.999	73.8963	1013.0	-0.5	96	343	4.5	64.4	19002	10	Unknown
RS-011	04	09	09	00	-163.158	74.5011	1010.1	-0.6	91	289	10.8	390.8	7045	10	St
RS-012	04	09	09	12	-168.705	74.9966	1014.5	-1.6	84	298	5.4	37.1	22569	9	As, Sc
RS-013	04	09	10	00	-172.027	74.8267	1013.0	-1.0	98	269	4.1	37.7	22479	10	Ns
RS-014	04	09	10	12	-174.001	75.2512	1015.2	-1.9	100	30	3.9	42.1	21722	9	St, Sc
RS-015	04	09	11	00	-174.011	75.9952	1016.5	-5.3	99	11	5.6	41.9	21739	10	Sc
RS-016	04	09	11	12	-176.505	75.7288	1016.3	-4.0	98	22	3.2	49.0	20720	10	Sc, As
RS-017	04	09	12	00	-178.089	75.1867	1015.6	-2.4	87	71	2.5	46.4	21049	10	Sc
RS-018	04	09	12	12	-179.905	75.2156	1017.4	-3.5	90	333	1.8	40.6	21915	10	As
RS-019	04	09	13	00	-179.627	76.0622	1017.3	-4.9	95	359	3.3	34.3	22970	10	Ns
RS-020	04	09	13	12	-175.136	76.1617	1018.3	-5.1	97	62	1.8	48.1	20770	10	St
RS-021	04	09	14	00	-170.578	75.6784	1019.7	-5.7	98	341	4.7	26.1	24701	8	As, Sc
RS-022	04	09	14	12	-168.922	75.4473	1020.9	-4.0	98	39	5.1	33.4	23106	10	Sc
RS-024	04	09	14	20	-166.075	74.7857	1021.9	-4.3	98	21	2.4	29.5	23883	10	Ns
RS-025	04	09	15	00	-165.819	74.1251	1022.1	-2.3	92	96	2.0	32.6	23258	9	Sc, As
RS-026	04	09	15	12	-165.835	71.1330	1020.1	1.4	72	89	5.7	35.6	22702	7	Sc
RS-027	04	09	16	00	-168.835	71.4952	1022.8	2.2	84	97	7.1	33.7	23042	8	As, Ac, Sc
RS-028	04	09	16	12	-168.853	73.7539	1025.0	-1.2	95	179	2.7	31.2	23531	10	Ns, Sc
RS-029	04	09	17	00	-169.974	75.9222	1019.9	0.3	97	196	9.1	28.6	24080	8	As, Sc
RS-030	04	09	17	12	-163.338	75.4981	1021.1	0.3	97	204	9.5	41.4	21693	10	Ns
RS-031	04	09	18	00	-165.076	76.3917	1017.5	-0.3	95	186	9.6	31.9	23361	8	Sc
RS-032	04	09	18	12	-167.999	75.6656	1013.4	-0.5	98	145	5.8	35.5	22670	10	Sc
RS-033	04	09	19	00	-169.172	76.3686	1009.2	-1.4	96	53	2.7	35.0	22749	10	As
RS-034	04	09	19	12	-163.941	75.9171	1004.8	-0.5	100	82	1.1	33.7	22974	10	St, Ns
RS-035	04	09	20	00	-159.535	75.9151	1005.1	-1.0	100	215	4.4	32.1	23281	10	St
RS-036	04	09	20	12	-159.150	75.0537	1004.9	0.0	100	20	0.7	37.1	22336	10	St
RS-037	04	09	21	00	-155.990	75.0003	1004.8	-1.0	84	149	6.2	30.8	23542	9	Sc, St
RS-038	04	09	21	12	-154.000	74.5034	1000.5	-2.5	91	58	6.2	28.9	23939	10	Sc
RS-039	04	09	22	00	-151.992	73.6062	994.1	-0.2	100	119	7.5	32.3	23230	10	St
RS-040	04	09	22	12	-153.002	73.2554	995.5	-1.1	92	63	9.4	27.5	24251	10	Sc
RS-041	04	09	23	00	-156.037	74.0103	996.8	-1.1	93	59	9.0	28.2	24076	9	As, Sc
RS-042	04	09	23	12	-159.429	74.8637	999.9	-1.8	88	60	8.5	34.5	22742	10	Ns
RS-043	04	09	24	00	-163.764	74.9997	1001.6	-1.3	96	29	5.8	36.7	22340	9	As, Sc
RS-044	04	09	24	12	-165.543	74.1386	1002.1	-0.7	85	63	7.0	34.1	22804	7	As
RS-045	04	09	25	00	-167.579	73.9740	1001.0	-2.0	89	22	6.3	26.0	24510	8	As, Ac
RS-046	04	09	25	12	-163.422	73.8344	995.1	-1.4	95	68	12.5	28.9	23822	10	Ns
RS-047	04	09	26	00	-160.347	73.2435	996.9	0.5	89	72	9.3	30.9	23409	7	Sc
RS-048	04	09	26	12	-156.678	72.3095	999.9	0.7	75	55	5.9	35.7	22506	8	Sc
RS-049	04	09	27	00	-153.830	71.6329	998.9	0.8	88	60	7.8	30.3	23580	8	St, Sc
RS-050	04	09	27	12	-157.303	72.7008	997.6	0.0	90	42	10.4	34.1	22801	-	Unknown
RS-051	04	09	29	00	-152.591	71.6903	1008.4	-1.7	85	9	13.3	29.9	23668	10	St
RS-052	04	09	29	12	-149.990	71.9849	1020.2	-4.0	85	10	9.2	32.0	23190	10	Sc
RS-053	04	09	30	00	-153.821	72.4755	1026.2	-2.5	61	292	3.9	48.4	20522	10	Sc
RS-054	04	09	30	12	-156.999	73.2513	1021.2	-3.0	85	153	2.7	32.6	23026	10	As
RS-056	04	09	30	18	-158.176	73.4914	1018.4	-1.9	46	161	2.4	28.0	23985	9	Sc
RS-057	04	10	01	00	-157.662	73.0861	1017.4	-1.9	60	103	4.6	34.4	22270	8	Sc, St
RS-058	04	10	01	12	-154.662	72.3357	1019.1	-2.0	59	148	3.1	36.2	22384	8	As
RS-059	04	10	02	00	-150.960	71.7547	1021.1	-1.2	54	152	4.9	36.8	22292	5	Ac, Sc
RS-060	04	10	02	12	-147.996	71.4629	1020.9	-1.5	63	122	10.0	35.4	22565	7	Sc
RS-061	04	10	03	00	-144.997	71.1802	1018.4	-0.7	78	118	9.2	37.4	22221	4	Sc
RS-062	04	10	03	12	-146.998	71.0347	1010.6	-0.3	86	97	10.5	38.3	22105	4	St, Sc
RS-063	04	10	04	00	-151.000	71.3839	1002.0	-0.4	91	75	11.4	30.4	23573	10	St
RS-064	04	10	04	12	-156.323	71.6993	1000.7	0.6	84	71	8.1	40.6	21746	10	As
RS-065	04	10	05	00	-158.135	71.1596	1000.9	0.8	78	66	7.2	40.7	21718	10	Sc
RS-066	04	10	05	12	-157.931	72.4708	1004.6	-1.7	92	63	10.7	35.9	22476	10	Unknown
RS-067	04	10	06	00	-159.335	73.4693	1006.5	-1.9	93	66	15.2	32.3	23126	10	St, Ac, As
RS-068	04	10	06	12	-160.513	74.5900	1010.5	-3.4	82	76	12.2	33.6	22785	0	-
RS-069	04	10	07	00	-161.658	73.7990	1010.1	-3.3	85	76	14.2	36.6	22270	7	Sc

(3-2) Tethered balloon

Tethered balloon observations were conducted under calm condition (wind speed was less than 10 m/s). Air temperature, relative humidity and air pressure were measured by using GPS sondes. Aerosol and condensation nuclei were measured by a Handheld Particle Counter (RION, HHPC-6-KR-12A) and a Condensation Particle Counter (TSI, Model 3007), respectively. Size distribution of cloud droplets was measured by a specially designed instrument. These instruments were attached to a string of tethered balloon. Table 7.1-2 summarizes the period of observations and measured components.

Table 7.1- 2 Tethered balloon observation

	1	2	3
Y/M/D	2004/09/14	2004/09/30	2004/10/04
Time	17:40-19:20 UTC	16:45-17:45 UTC	21:15 UTC
Position	75.00N, 165.74 W	73.50N, 158.02W	
Measured components	T, RH, P, HHP, Cloud droplets	T, RH, P, HHP,CN	failed
Highest level	1600 m	1000 m	failed

(3-3) Aerosol measurement

We operated continuously a Handheld Particle Counter (RION, HHPC-6-KR-12A), which counted number concentration of aerosols larger than 0.3, 0.5, 0.7, 1.0, 2.0 and 5.0 μ m in diameter. Total number density of condensation nuclei (CN) larger than 0.01 μ m was measured by using a Condensation Particle Counter (TSI, Model 3007). Sampling interval of OPC and CN were 3min and 1min, respectively.

(3-4) Doppler Radar (C-band)

C-band Doppler radar observed three dimensional radar echo structure and wind fields of rain/snow cloud. Measured parameters are radar reflectivity factor (dBZ), Doppler velocity (m/s), and velocity width (m/s). The specifications of R/V MIRAI shipboard Doppler radar (RC-52B, Mitsubishi Electric Co. Ltd., Japan) are as follows.

Frequency:	5290MHz (C-band)
Beam Width:	better than 1.5 degrees
Transmit Power:	250kW (Peak Power)
Signal Processor:	RVP-7 (Sigmet Inc., U.S.A)
Inertial Navigation Unit:	DRUH (Honeywell Inc., U.S.A)
Application Software:	IRIS/Open Ver.8.05.10 (Sigmet Inc., U.S.A)

We checked transmitted frequency, mean output power and pulse repetition frequency (PRF) once per a few days. Pulse width and the amplifier were checked before and after the cruise. The observation was performed throughout this cruise. During the observation, the programmed “tasks” were repeated every 10 minutes. One cycle consists of one-elevation “Surveillance” PPI with Intensity-mode (300-km range for reflectivity), one “volume scan” (consists of 19 PPI scans) with Doppler-mode (160-km range for reflectivity, Doppler velocity and velocity width). RHI (Range Height Indicator) scans with Doppler-mode were intermittently operated to obtain detailed vertical cross sections of precipitating clouds. The parameters for the above three tasks are listed in Table 7.1-3.

Table 7.1- 3 Selected parameters of C-band Doppler radar

	Surveillance PPI	Volume scan	RHI
Pulse width	2.0 [μ s]	0.5 [μ s]	
Scan speed	18 [deg/sec]		Automatically determined
PRF	260 [Hz]	900/720 [Hz]	
Sweep integration	32 samples		
Ray spacing	about 1.0 [deg]		0.2 [deg]
Bin spacing	250 [m]	125 [m]	
Elevations	0.5	0.5, 1.2, 2.0, 3.0, 4.0, 5.0, 6.0, 7.0, 8.0, 9.0, 10.1, 11.3, 12.8, 14.6, 16.6, 18.9, 21.6, 25.0, 29.0	0.0 to 70.0
Azimuths	Full Circle		0.0, 90.0, 180.0, 270.0
Range	300 [km]	160 [km]	
Software Filters	No filter	Dual-PRF velocity unfolding	
Gain control	Fixed		

(3-5) Cloud radar

Chiba University has developed an FM-CW cloud radar at 95 GHz. During the cruise of Mirai, the radar system was set in a container on the upper deck of Mirai to study vertical distribution and microphysics of clouds. The radar was continuously operated during the cruise. The basic operating parameters of antenna are listed in Table 7.1-4.

Table 7.1-4 Basic operating parameters of FM-CW radar.

Antenna Diameter 1 m
f/D ration of Antenna 0.35
Antenna Optics Cassegrain
Gain of Antennas 57 dBi
Beam Width 0.18 degree
Antenna Separation 1.4 m
Direction of Antennas Zenith
Polarization 1 Linear

(3-6) Dual polarization lidar

Vertical profiles of aerosols and clouds were measured with a dual polarization lidar. The lidar employs a Nd:YAG laser as a light source. The receiver telescope has a diameter of 25 cm. The detected signals were recorded with a digital oscilloscope and stored on a hard disk with a computer. The lidar system was installed in a 20-ft container. The container has a glass window on the roof, and the lidar was operated continuously regardless of weather. Measured parameters are Vertical profiles of backscattering coefficient and depolarization ratio. Height and temporal resolutions are 6 m and 10 seconds, respectively.

(4) Preliminary results

The horizontal extent of sea-ice is decreasing in the Arctic Ocean. In contrast to tropical region, the low-level cloud is predominant and plays an essential role in the radiative heat balance in the Arctic region. Some researchers suggest that increasing low-level cloud cover and resulted increasing longwave radiation would accelerate the melting of sea-ice. Before discussing the strong coupling among the sea ice, the albedo, and the clouds (termed ice-albedo and cloud-radiation feedback), we have to know how sea surface conditions (SST, wind speed, salinity) affect the number density of CCN, because optical properties of low-level cloud are controlled by CCN in the boundary layer. Many researchers measured the size distribution and chemical components of aerosols in the Arctic region. Most of them discussed the source of aerosols by using trajectory analysis, and never discussed the mesoscale inhomogeneity of horizontal and vertical distribution of aerosols in the Arctic Ocean. By making use of the Arctic cruises of R/V MIRAI (2002 and 2004), we tried to study strong coupling among air-ocean-aerosol-cloud in the Arctic Ocean.

Figure 7.1-1 shows a vertical profile of number density of condensation nuclei ($>0.01 \mu\text{m}$). Same with those observed at MR02K05 in 2002, the number density of CN was almost constant below the cloud base.

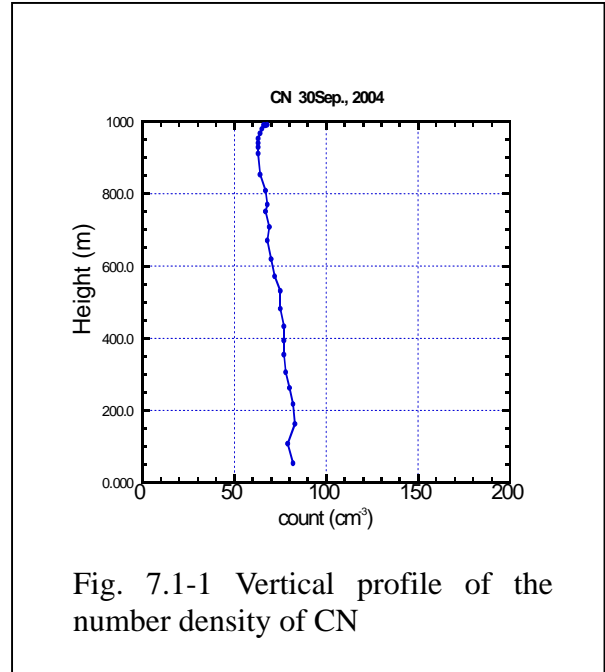

Fig. 7.1-1 Vertical profile of the number density of CN

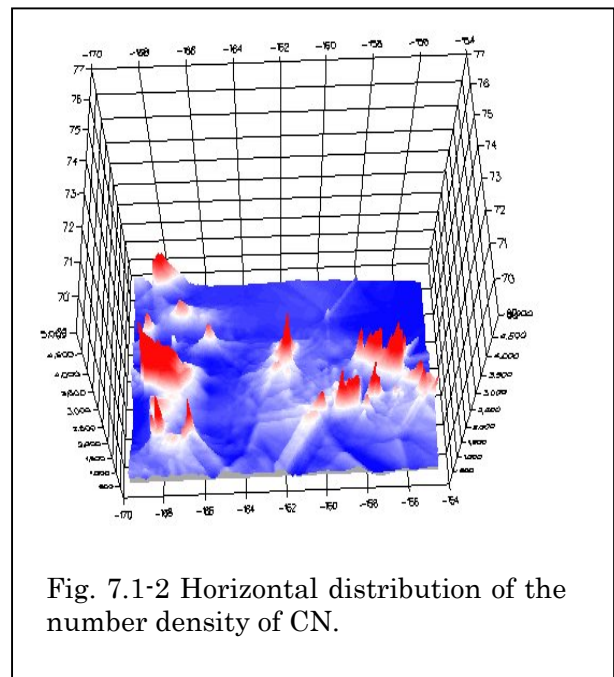

Fig. 7.1-2 Horizontal distribution of the number density of CN.

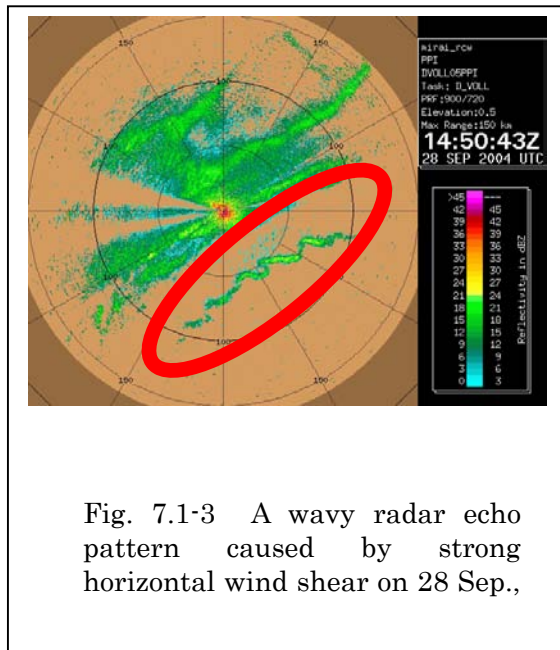

Fig. 7.1-3 A wavy radar echo pattern caused by strong horizontal wind shear on 28 Sep.,

Figure 7.1-2 shows horizontal distribution of the number density of CN. Different from the vertical profile of CN shown in Figure 7.1-1, CN distributed inhomogeneously.

We observed various kinds of disturbances, that is, synoptic-scale lows, meso-scale lows, gust fronts, cloud streets, banded clouds etc. Figure 7.1-3 shows one of the most interesting radar echo pattern caused by the strong horizontal wind shear.

(5) Archives

All data will be archived by Hokkaido University and submitted to JAMSTEC Data Management Office.

7.2. Surface Atmospheric Turbulent Flux

(1) Personnel

Souichiro Sueyoshi (GODI): On-board collaborator

Katsuhisa Maeno (GODI) : On-board collaborator

Kazuho Yoshida (GODI) : On-board collaborator

On-shore scientists:

Kunio Yoneyama (JAMSTEC) : Principal Investigator

Osamu Tsukamoto (Okayama University)

Hiroshi Ishida (Kobe University)

(2) Objective

To better understand the air-sea interaction, accurate measurements of surface heat and fresh water budgets are necessary as well as momentum exchange through the sea surface. In addition, the evaluation of surface flux of carbon dioxide is also indispensable for the study of global warming. Sea surface turbulent fluxes of momentum, sensible heat, latent heat, and carbon dioxide were measured by using the eddy correlation method that is thought to be most accurate and free from assumptions. These surface heat flux data are combined with radiation fluxes and water temperature profiles to derive the surface energy budget.

(3) Sampling elements

3-dimensional wind components, air temperature, relative humidity, water vapor, CO₂, ship's motion (acceleration, pitching, rolling)

(4) Inventory information for the sampling

All data were continuously obtained during the whole cruise.

(5) Instruments and methods

The surface turbulent flux measurement system consists of turbulence instruments (Kaijo Co., Ltd.) and ship motion sensors (Kanto Aircraft Instrument Co., Ltd.). The turbulence sensors include a three-dimensional sonic anemometer-thermometer (Kaijo, DA-600) and an infrared hygrometer (LICOR, LI-7500). The sonic anemometer measures three-dimensional wind components relative to the ship. The ship motion sensors include a two-axis inclinometer (Applied Geomechanics, MD-900-T), a three-axis accelerometer (Applied Signal Inc., QA-700-020), and a three-axis rate gyro (Systron Donner, QRS-0050-100). LI7500 is a CO₂/H₂O turbulence sensor that measures turbulent signals of carbon dioxide and water vapor simultaneously. Fig. 7.2-1 shows the installation of the instruments at the top of the foremast.

These signals are sampled at 10 Hz by a PC-based data logging system (Labview,

National Instruments Co., Ltd.). By obtaining the ship speed and heading information through the Mirai network system it yields the absolute wind components relative to the ground. Combining wind data with the turbulence data, turbulent fluxes and statistics are calculated in a real-time basis.

(6) Results

Data will be processed after the cruise at Okayama University.

(7) Data Archives

All data are archived at Okayama University, and will be open to public after quality checks and corrections. Corrected data will be submitted to JAMSTEC Data Management Division.

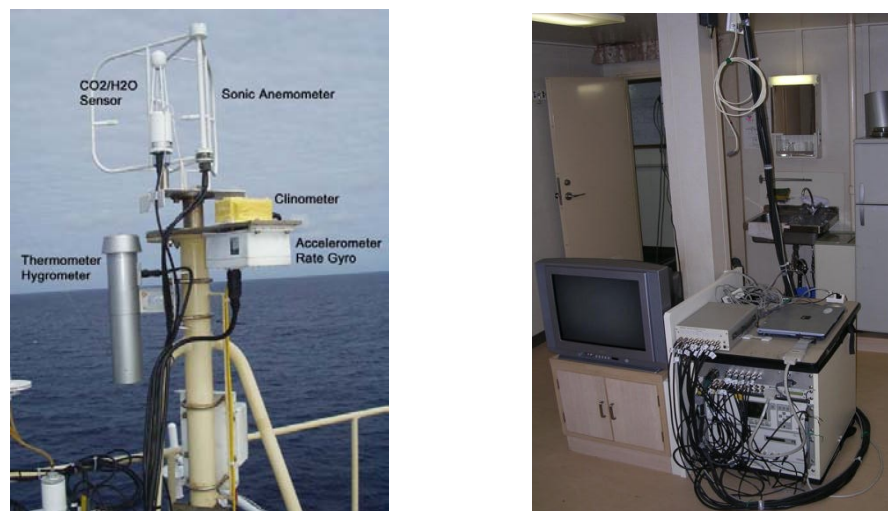

Fig. 7.2-1 Turbulent flux measurement system on the top deck of the foremast (left) and data processing unit (right)