

R/V Yokosuka and Shinkai 6500 Cruise Report

YK12-05



Okinawa Trough

April 23rd – May 8th, 2012

Japan Agency for Marine-Earth Science
and Technology (JAMSTEC)
University of Tokyo, Kochi University
and Kyoto University

Contents

1. Cruise Information
2. Researchers and Crews
3. Introduction
 - 3.1. Summary of the Cruise
 - 3.2. Cruise schedule and operations
 - 3.3. Shipboard Log
4. Research Objectives
 - 4.1. Marine CSEM survey
 - 4.2. Geochemical Mapping
5. Instruments and Operation Methods
 - 5.1. Marine CSEM survey
 - 5.2. Geochemical sensors
6. Preliminary Results
 - 6.1. Marine CSEM survey
 - 6.2. Geochemical sensors
7. Acknowledgements

1. Cruise Information

Cruise ID: YK12-05
Name of vessel: R/V Yokosuka
Title of the cruise: Submersible SHINKAI 6500 Dives (Okinawa Trough)
Chief scientist: Tada-nori Goto [Kyoto University]
Cruise period: April 23rd - May 8th, 2012
Ports of call: JAMSTEC Yokosuka pier – JAMSTEC Yokosuka pier
Research area: Okinawa Trough

- i. Iheya North Area (Water Depth =700m-1,700m)
Area surrounded by the following LAT/LON.
27°45.0'N 27°50.0'N
126°50.0'E 126°57.0'E
- ii. Irabu knoll (Water Depth= 1,650m-2,000m)
Area surrounded by the following LAT/LON.
25°13.0'N 25°15.0'N
124°51.5'E 124°53.5'E

Purpose:

On the basis of project by MEXT, “Program of development of fundamental tools for advancing the availability of marine resources”, we conducted the research dive of submersible SHINKAI 6500. The main purposes of this cruise are summarized below:

Representative of the Science Party

Theme 1: Tatsuhiro Fukuba (University of Tokyo*) *current affiliation: MARITECH/JAMSTEC
Theme 2: Tada-nori Goto (Kyoto University)

Title of proposal

Theme 1: Research on exploration of seafloor hydrothermal activity by tracing the hot water plume with geochemical sensors
Theme 2: Geophysical exploration of seafloor massive sulfide off Okinawa area

2. Researchers and Crews

Researchers

| | |
|-------------------------|--|
| Associate Professor | Tada-nori Goto [Graduate School of Engineering, Kyoto University] |
| Technical Scientist | Tatsuhiro Fukuba [MARITECH JAMSTEC] |
| Postdoctoral researcher | Katsuo Mogi [University of Tokyo] |
| Associate Professor | Kei Okamura [Center for Advanced Marine Core Research, Kochi University] |
| Postdoctoral researcher | Takuroh Noguchi [Center for Advanced Marine Core Research, Kochi University] |
| Ph.D. student | Naoto Imamura [Graduated school of Science, University of Kyoto] |
| Master. student | Yousuke Teranishi [Graduated school of Science, University of Kyoto] |
| Researcher | Takafumi Kasaya [IFREE JAMSTEC] |
| Research Scientist | Katrin Schwalenberg [BGR] |
| Scientist | Hendrik Muler [University of Bremen] |
| Marine Technician | Shusuke Machida [Nippon Marine Enterprises, Ltd.] |

“SHINKAI 6500” Operation Team

| | |
|-----------------------------------|---------------------|
| Operation Manager | Satoshi Ogura |
| Operation Co-Manager | Kazuhiro Chiba |
| 1 st Submersible Staff | Kazuki Iijima |
| 1 st Submersible Staff | Masanobu Yanagitani |
| 1 st Submersible Staff | Kazuya Mitsufuji |
| 1 st Submersible Staff | Keita Matsumoto |
| 2 st Submersible Staff | Hirofumi Ueki |
| 2 st Submersible Staff | Yosuke Chida |
| 2 st Submersible Staff | Keigo Suzuki |
| 2 nd Submersible Staff | Takuma Onishi |
| 2 nd Submersible Staff | Masaya Katagiri |
| 3 rd Submersible Staff | Hitomi Ikeda |
| 3 rd Submersible Staff | Shouta Ihara |

R/V YOKOSUKA Crews

| | |
|--------------------------------|--------------------|
| Captain | Eiko Ukekura |
| Chief Officer | Yasuhiko Sammori |
| 2 nd Officer | Tomoyuki Takahashi |
| 3 rd Officer | Hiroharu Omae |
| Chief Engineer | Eiji Sakaguchi |
| 1 st Engineer | Takashi Ota |
| 2 nd Engineer | Kenta Ikeguchi |
| 3 rd Engineer | Koichi Hashimoto |
| Chief Radio Operator | Fukuo Suda |
| 2 nd Radio Operator | Hiroki Ishiwata |
| 3 rd Radio Operator | Takatomo Shirozume |
| Boat Swain | Yoshiaki Kawamura |
| Able Seamen | Tsuyoshi Chimoto |
| Able Seamen | Masanori Ohata |
| Able Seamen | Yuki Yoshino |
| Able Seamen | Takuya Miyashita |
| Sailer | Shinya Ueno |
| Sailer | Yuta Motooka |
| No.1 Oiler | Kozo Miura |
| Oiler | Katsuyuki Miyazaki |
| Oiler | Sota Misago |
| Oiler | Katsuyuki Miyazaki |
| Assistant Oiler | Eiji Aratake |
| Assistant Oiler | Daiki Sato |
| Chief Steward | Tomihisa Morita |
| Steward | Yoshinobu Hasatani |
| Steward | Tatsunari Onoue |
| Steward | Toru Wada |
| Steward | Takahiro Abe |
| Steward | Masaru Takada |

3. Introduction

3.1 Summary of cruise

- 1) Research on exploration of seafloor hydrothermal activity by tracing the hot water plume with geochemical sensors

Geochemical survey operations had been conducted focusing on the hydrothermal activity in the Iheya-North Knoll and the Irabu Knoll area. For the dive 1299 and 1300, SHINKAI 6500 dived to the Iheya-North Knoll hydrothermal site for operational tests of chemical sensors, an in situ analyzers and water samplers mounted on the vehicle as a payload apparatus. As a result, all chemical sensors, in situ analyzers, and water samplers were worked correctly and geochemical anomalies on various chemical parameters such as pH, Mn, H₂S, ORP, CTD and turbidity were successfully observed in hydrothermal plumes. Hydrothermal site at the Irabu Knoll was explored using the SHINKAI 6500 with the payload sensors in detail during dive 1301 and 1302. Hydrothermal plume mapping was conducted during dive 1301 at the hydrothermal site that is located on the top of western knoll. At the northern caldera-like landform, we conducted hydrothermal site survey using 2 dives. As a result, hydrothermal active sites were successfully discovered based on a real-time data from pH sensor and Mn analyzer during the dives. Water samples were collected simultaneously during all survey operations.

- 2) Geophysical exploration of seafloor massive sulfide off Okinawa area

We developed AUV-based controlled-source electromagnetic (CSEM) survey system which can be applied to exploration of seafloor massive sulphide. Our system can be attached to AUV “Urashima” and other various platforms, and allows us to image sub-seafloor resistivity structure with depth of several tens to hundreds meters. In this research cruise, we attached our CSEM instrument to the submersible SHINKAI 6500, and conducted the electromagnetic survey around the Iheya north knoll, located in the Okinawa Trough. In the Iheya north knoll, the hydrothermal activity is high at several mounds, and seafloor massive sulphide (SMS) deposits are observed on the seafloor. In addition, the borehole sampling and logging were carried out by D/V Chikyu, and the approximated geological structure (e.g., distribution of anhydrite and the underlying high-temperature fluid). In general, both the metallic deposits and high-temperature fluid indicate low resistivity. If the seafloor resistivity distribution derived by our survey system is obtained, we can discuss about the detailed distributions of SMS and subsurface fluid.

In this cruise, we carried out the experiment with two dive of SHINKAI 6500. We attached the

transmitter for artificial electromagnetic signals to SHINKAI 6500. We also deployed and retrieved the six ocean-bottom electro-magnetometers (OBEM) as receivers. On the basis of preliminary analysis, the electromagnetic field transmitted from the submersible was successfully received by the ocean bottom receivers in and around the hydrothermal area. Also, the receiver attached to the submersible itself found the low resistive seafloor near the hydrothermal mounds. The data will give us information about the mapping of seafloor and sub-seafloor resistivity distribution.

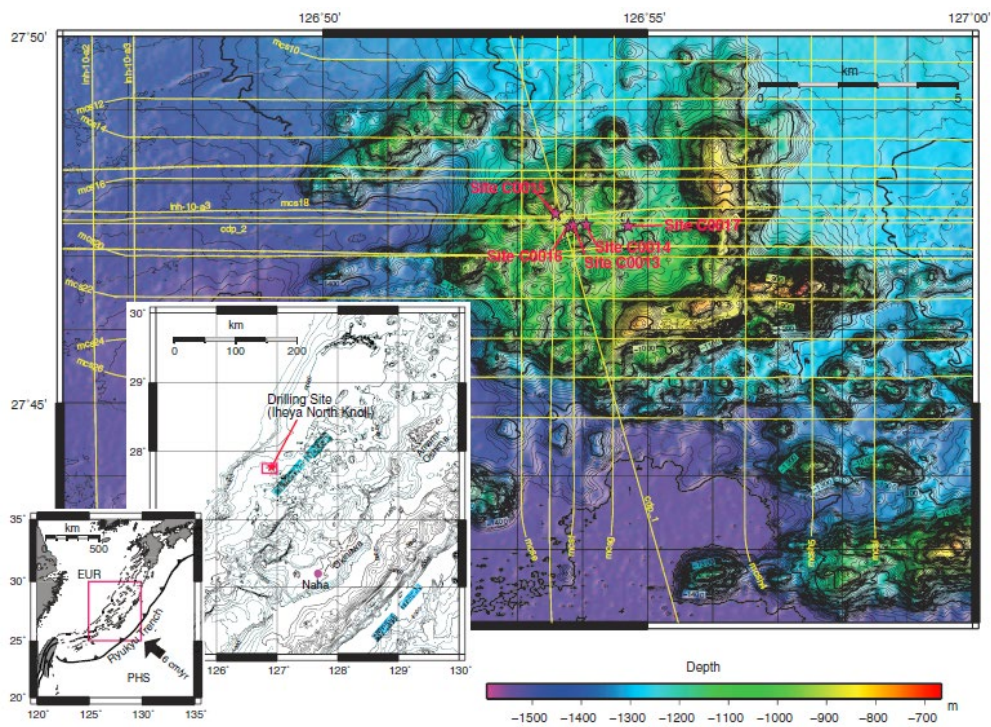

Fig. 3.1.1. Area map of Iheya North Knoll showing drilling sites C0013-C0017 (Expedition 331 Scientists, 2010).

References

Expedition 331 Scientists (2010): Deep hot biosphere. *IODP Prel. Rept.*, 331. doi:10.2204/iodp.pr.331.2010.

3.2 Cruise schedule and operations

April 23 (Mon.)

Departure at the JAMSTEC pier at 10:00 JST.

Transit to the Okinawa area under the bad weather condition.

April 24 (Tue.)

Transit to the Okinawa area.

Scientific instruments, the controlled-source unit for electromagnetic survey (CSEM unit) and the geochemical sensors, were tested. Preparation of ocean bottom electromagnetometers (OBEMs) was done.

April 25 (Wed.)

Transit to the Okinawa area.

Scientific instruments (CSEM unit for electromagnetic survey and geochemical sensors) were tested and loaded to the submersible SHINKAI 6500 (6K). The artificial electric current was sent to the salt water tank on the deck, and we checked the successful works of both 6K system and CSEM unit.

The OBEMs were ready for deployment.

April 26 (Thu.)

Arrival off the Naha port. Seven scientists arrived at the vessel using the launch.

Transit to the Iheya north knoll.

April 27 (Fri.)

Six OBEMs were deployed in the Iheya north knoll. The site separation was about 100-200m.

Although the rough seafloor and strong water current with speed of 1-2 knots made the operation difficult, careful predictions and treatments by the captain and ship's crew results in the successful deployment.

The acoustic communication of landing OBEMs was good, and the acoustic ranging between the vessel and OBEMs were measured for detection of the landing location of OBEMs.

April 28 (Sat.)

6K started the dive around 10:00 (dive# 1297). In the Iheya north knoll, artificial electric current was sent by using the CSEM unit. It was the first experiment to attach the unit to 6K, and it worked well without any interruptions to 6K operations. During the dive, we achieved the current shooting along the initially planned four lines. As a result, we will make a map of electrical resistivity below the seafloor in the area of 900m x 400m. The area includes the hydrothermal vents and the borehole sites by D/V

Chikyu. The first look of raw data indicates the successful measurement of seafloor resistivity values. The OBEMs on seafloor should also record the signal from 6K.

6K launched from seafloor at 16:15, arrived at the surface, and retrieved on the deck around 17:00.

April 29 (Sun.)

6K started the dive around 10:00 (dive# 1298). In the Iheya north knoll, artificial electric current was sent by using the CSEM unit. As same as the last dive, 6K cruised along two lines with the current shooting. Rock samples (sulphide) were also collected at three sites near the hydrothermal mounds.

6K launched from seafloor at 16:25, arrived at the surface, and retrieved on the deck around 17:00.

After the recovery operation of 6K, one OBEM is recovered by sending the acoustic command to release the weight.

April 30 (Mon.)

From 6:00, one OBEM was recovered by its self pop-up system.

6K started the dive to the Iheya north knoll around 10:00 (dive# 1299). The major purpose for this dive was geochemical mapping of water around the hydrothermal vents. On 6K, geochemical sensors and water samplers were loaded. The total number of measured components was nearly ten. The cruise was done not only near the seafloor but also with several altitude, which is useful for three-dimensional distribution of chemical anomalies around the hydrothermal area.

6K launched from seafloor at 16:25, arrived at the surface, and retrieved on the deck around 17:00.

After the recovery operation of 6K, two OBEMs were recovered by their self pop-up.

May 1(Tue.)

From 6:00, one OBEM was recovered by its self pop-up system.

6K started the dive to the Iheya north knoll around 10:00 (dive# 1300). 6K carried out the geochemical mapping of water around the hydrothermal vents. 6K launched from seafloor at 15:20, arrived at the surface, and retrieved on the deck around 16:10.

After the recovery operation of 6K, one OBEM was recovered by their self pop-up. We finish the recovery of all six OBEMs deployed in this area, and went to the Naha port, Okinawa.

May 2 (Wed.)

Arrival off the Naha port. At 7:20, four scientists left the vessel at the Naha port by a launch.

Transit to the second survey area, the Irabu knoll.

Around 19:00, we arrived at the Irabu knoll and started the topography survey.

May 3 (Thu.)

6K started the dive to the Irabu knoll around 10:00 (dive# 1301). The major purpose for this dive was geochemical mapping of water around the hydrothermal vents. On the basis of monitored values of geochemical sensors, 6k tried to find unknown hydrothermal vents. Geochemical anomalies were obtained at several areas during the dive, and some of them showed the characteristic biospheres on seafloor possibly related to the hydrothermal activities. However, new hydrothermal vents were not found during the dive.

6K launched from seafloor at 16:00, arrived at the surface, and retrieved on the deck around 17:00.

May 4 (Fri.)

6K started the dive to the Irabu knoll around 10:00 (dive# 1302). 6K carried out geochemical mapping of water around the hydrothermal vents. The monitored values of geochemical sensors was helpful for finding unknown hydrothermal vents. In this dive, a small-scale hydrothermal vents were found by the geochemical sensors.

6K launched from seafloor at 16:00, arrived at the surface, and retrieved on the deck around 17:00.

May 5 (Sat.)

We returned to the Iheya north knoll and conducted the surface geophysical survey (topography survey, gravity survey and geomagnetic survey with vector and scalar observation) by using the vessel's equipments. The survey was started from 6:00 and finished until 10:30.

Transit to the JAMSTEC pier, Yokosuka.

May 6 (Sun.)

Transit to the JAMSTEC pier, Yokosuka.

AM: Onboard seminar by two scientists including the preliminary discoveries in this cruise.

May 7 (Mon.)

Transit to the JAMSTEC pier, Yokosuka.

May 8 (Tue.)

Arrival at the JAMSTEC pier at 6:30.

3.3. Shipboard Log

YK12-05 Shipboard Log:

Date Time Log

2012/04/23

Position: 35-04.1N, 139-38.1E / Weather: rainy / Wind direction: SE/ Wind force: 5/ Wave: 4 m/ Swell: 3 m/ Visibility: 2 nautical miles (12:00 JST+1h)

09:00 Onboard (3 scientists)
10:00 Departure from YOKOSUKA (JAMSTEC)
11:20 Briefing about ship's life and safety
16:40 Praying for the safety of this cruise (Konpira ceremony)

2012/04/24

Position: 33-09.4N, 134-10.0E / Weather: fine but cloudy / Wind direction: East/ Wind force: 3/ Wave: 2 m/ Swell: 1 m/ Visibility: 7 nautical miles (12:00 JST+1h)

08:30 Set up the laboratory
13:00 Briefing about Shinikai6500

2012/04/25

Position: 28-46.4N, 129-24.8E / Weather: overcast / Wind direction: SSE/ Wind force: 7/ Wave: 4m/ Swell: 3 m/ Visibility: 6 nautical miles (12:00 JST+1h)

08:00 Payload operational check

2012/04/26

Position: 26-35.9N, 127-28.3E / Weather: overcast / Wind direction: North/ Wind force: 6/ Wave: 4m/ Swell: 3 m/ Visibility: 6 nautical miles (12:00 JST)

06:45 Checking on buoyancy new type OBEM
08:00 Payload operational check
09:00 Onboard (7 scientists)
10:00 Departure from Naha
11:00 Briefing about ship's life and safety
18:00 Scientific meeting
19:00 Arrived at survey area (Iheya North)
19:10 XBT

2012/04/27

Position: 27-47.4N, 126-53.8E / Weather: Blue sky/ Wind direction: ENE/ Wind force: 2/

Wave: 2m/ Swell: 1 m/ Visibility: 8 nautical miles (12:00 JST)

06:16 MBES mapping survey for 6k dive
06:47 End of the geological survey (MBES)
08:11 Deployed OBEM Site 6
09:02 Calibrating position of OBEM Site 6
09:32 Deployed OBEM Site 5
09:57 Landing on the bottom OBEM Site 5
10:19 Deployed OBEM Site 4
10:43 Landing on the bottom OBEM Site 4
11:05 Deployed OBEM Site 3
11:29 Landing on the bottom OBEM Site 3
11:55 Deployed OBEM Site 2
12:18 Landing on the bottom OBEM Site 2
13:04 Deployed OBEM Site 1
13:26 Landing on the bottom OBEM Site 1
14:38 Calibrating position of OBEM Site 1 and Site 2
15:48 Calibrating position of OBEM Site 3 and Site 4
17:00 Calibrating position of OBEM Site 5 and Site 6
18:25 Sub Bottom Profiler(SBP) survey
19:23 Finished SBP

2012/04/28

Position: 27-47.6N, 126-54.2E / Weather: Overcast/ Wind direction: East/ Wind force: 4/ Wave:

3m/ Swell: 1 m/ Visibility: 7 nautical miles (12:00 JST)

09:51 Launched Shinkai6500 (6kDive#1297dive)
10:47 Shinkai6500 lands (Depth:1064m)
16:13 Shinkai6500 leaves the bottom (Depth:1034m)
17:17 Shinkai6500 on deck
17:57 Towing Proton magnetometer (Start of the geological survey)
18:46 MNBES mapping survey
19:30 Scientific meeting
21:26 Finished MNBES
22:15 Proton on deck

2012/04/29

Position: 27-47.7N, 126-54.0E / Weather: Rainy/ Wind direction: SE/ Wind force: 6/ Wave: 4m/ Swell: 3 m/ Visibility: 5 nautical miles (12:00 JST)

10:03 Launched Shinkai6500 (6kDive#1298dive)
10:54 Shinkai6500 lands (Depth:1064m)
16:25 Shinkai6500 leaves the bottom (Depth:984m)
17:24 Shinkai6500 on deck
18:20 Sending release command OBEM Site 5
19:14 Recovered OBEM Site 5

2012/04/30

Position: 27-47.5N, 126-54.3E / Weather: overcast/ Wind direction: West/ Wind force: 4/ Wave: 4m/ Swell: 3 m/ Visibility: 5 nautical miles (12:00 JST)

06:00 Sending release command OBEM Site 6
07:14 Recovered OBEM Site 6
09:53 Launched Shinkai6500 (6kDive#1299dive)
13:25 Shinkai6500 lands (Depth:981m)
16:15 Shinkai6500 leaves the bottom (Depth:914m)
17:18 Shinkai6500 on deck
17:30 6K tour of inspection for scientists
17:54 Sending release command OBEM Site 2
18:35 Recovered OBEM Site 2
18:50 Sending release command OBEM Site 4
19:43 Recovered OBEM Site 4

2012/05/01

Position: 27-47.5N, 126-54.1E / Weather: overcast / Wind direction: South/ Wind force: 5/ Wave: 4m/ Swell: 3 m/ Visibility: 7 nautical miles (12:00 JST)

06:00 Sending release command OBEM Site 3
06:47 Recovered OBEM Site 3
09:59 Launched Shinkai6500 (6kDive#1300dive)
10:50 Shinkai6500 lands (Depth:1059m)
15:26 Shinkai6500 leaves the bottom (Depth:929m)
16:18 Shinkai6500 on deck
16:56 Sending release command OBEM Site 1
17:30 6K tour of inspection for scientists

17:42 Recovered OBEM Site 1
17:45 Left research area (Iheya North) for NAHA

2012/05/02

Position: 25-51.1N, 126-51.6E / Weather: cloudy / Wind direction: West/ Wind force: 3/ Wave: 3m/ Swell: 1 m/ Visibility: 7 nautical miles (12:00 JST)

07:00 Arrival at NAHA
07:30 4 scientists disembarked by traffic boat
08:00 Departure from NAHA, proceeded to research area (Irabu knoll)
18:00 Scientific meeting
18:45 Arrival at survey area (Irabu knoll)
18:56 XBT
19:25 MNBES mapping survey
19:30 Meeting with 6K team
19:43 Finished MNBES

2012/05/03

Position: 25-13.6N, 124-52.2E / Weather: fine but cloudy / Wind direction: North/ Wind force: 4/ Wave: 3m/ Swell: 1 m/ Visibility: 8 nautical miles (12:00 JST)

09:48 Launched Shinkai6500 (6kDive#1301dive)
10:42 Shinkai6500 started operations (Depth:1526m)
11:19 Shinkai6500 lands (Depth:1673m)
15:55 Shinkai6500 leaves the bottom (Depth:1985m)
17:15 Shinkai6500 on deck

2012/05/04

Position: 25-14.2N, 124-53.1E / Weather: rainy / Wind direction: North/ Wind force: 5/ Wave: 3m/ Swell: 1 m/ Visibility: 6 nautical miles (12:00 JST)

09:53 Launched Shinkai6500 (6kDive#1302dive)
11:02 Shinkai6500 lands (Depth:1891m)
16:10 Shinkai6500 leaves the bottom (Depth:1817m)
17:22 Shinkai6500 on deck
18:00 Left research area (Irabu knoll) for Iheya North

2012/05/05

Position: 27-57.0N, 127-11.0E / Weather: fine but cloudy / Wind direction: NE/ Wind force: 3/

Wave: 2m/ Swell: 1 m/ Visibility: 8 nautical miles (12:00 JST)

05:51 Towing Proton magnetometer (Start of the geological survey)
06:00 Arrival at survey area (Iheya North)
10:58 Proton on deck
11:00 Left research area (Iheya North) for YOKOSUKA
11:05 6K tour of inspection for scientists /steward/assistant Oiler/sailors

2012/05/06

Position: 27-57.0N, 127-11.0E / Weather: fine but cloudy / Wind direction: NE/ Wind force: 3/

Wave: 2m/ Swell: 1 m/ Visibility: 8 nautical miles (12:00 JST)

09:00 Scientific seminar
13:00 6K tour of inspection for scientists /steward/assistant Oiler/officer and sailors

2012/05/07

Position: 27-57.0N, 127-11.0E / Weather: fine but cloudy / Wind direction: NE/ Wind force: 3/

Wave: 2m/ Swell: 1 m/ Visibility: 8 nautical miles (12:00 JST)

08:00 Setting up unrig
13:00 Cleaning at the lab

2012/05/08

Position: 27-57.0N, 127-11.0E / Weather: fine but cloudy / Wind direction: NE/ Wind force: 3/

Wave: 2m/ Swell: 1 m/ Visibility: 8 nautical miles (12:00 JST)

06:00 Arrival at YOKOSUKA
12:00 YK12-05 finished and disembarkation

4. Research Objectives

4.1. Marine CSEM survey

The recent growth of world-wide requirement of metals demands advanced explorations for finding metal mine and deposits. Especially, the submarine massive sulfides (SMS) have attracted mining companies because of its compactness with high grades. However, few exploration techniques were developed to evaluate the thickness of SMS and to find the buried SMS.

One of the great problems is the rough seafloor feature near the hydrothermal area, which restricts the ways for marine controlled-source electromagnetic (CSEM) survey. Recently, the deep-towed CSEM technique is used for imaging the shallower structure below the seafloor for detection of methane hydrate etc. (e.g., Schwalenberg et al., 2005). However, the deep-towed CSEM survey requires a long towed cable for source and receiver electrodes. The rough topography does not allow the towing just on the seafloor. The high altitude of towed cable gives us a chance of towing but the obtained data mainly reflect the seawater layer below the cable, so that the resolution to the sub-seafloor structure is decreased.

Here, we propose a new EM exploration technique with a submersible “SHINKAI 6500 (6k)” as shown in Fig. 4.1.1. In our concept, the submersible-based CSEM survey system consists of two instruments; a transmitter and receivers attached to the SHINKAI 6k and seafloor receivers. If the cruising altitude of the SHINKAI 6k can be kept with a lower level ($< 2\text{m}$), the seafloor receivers (ocean-bottom electromagnetometers=OBEMs or ocean bottom electrometers=OBES) allow us to obtain the deeper images below the seafloor. In addition, a different receiver attached to the SHINKAI 6k will give us information about the seafloor resistivity. Also, we conduct the sampling of volcanic rocks by the SHINKAI 6k. The laboratory measurements of resistivity, seismic velocity, density etc. with description of lithology will be necessary for interpretation of our CSEM results.

In this cruise, we examine our CSEM system to image the sub-seafloor resistivity structure below the hydrothermal vents and possibly SMS deposits around them in the Iheya North area. As reported by Expedition 331 Scientists (2010), the Iheya North hydrothermal field is located in the middle Okinawa Trough, an actively spreading backarc basin that extends for 1200 km between the Ryukyu arc-trench system and the Asian continent, in a transitional region between continental and oceanic crust. Integrated Ocean Drilling Program (IODP) Expedition 331, the Deep Hot Biosphere project, drilled into the Iheya North hydrothermal system in order to investigate diverse subseafloor hydrothermal circulations and its relationship to microbial ecosystems. The water depth of the central Iheya North area is about 900-1200m. There are many active and inactive

chimneys at the central area, which will possibly consist of seafloor massive sulfide. On the basis of comparison between the resistivity distribution obtained in this cruise and the geological settings around the Iheya North area, we can discuss how effectively new marine EM sounding techniques with a submersible gives us information about SMS.

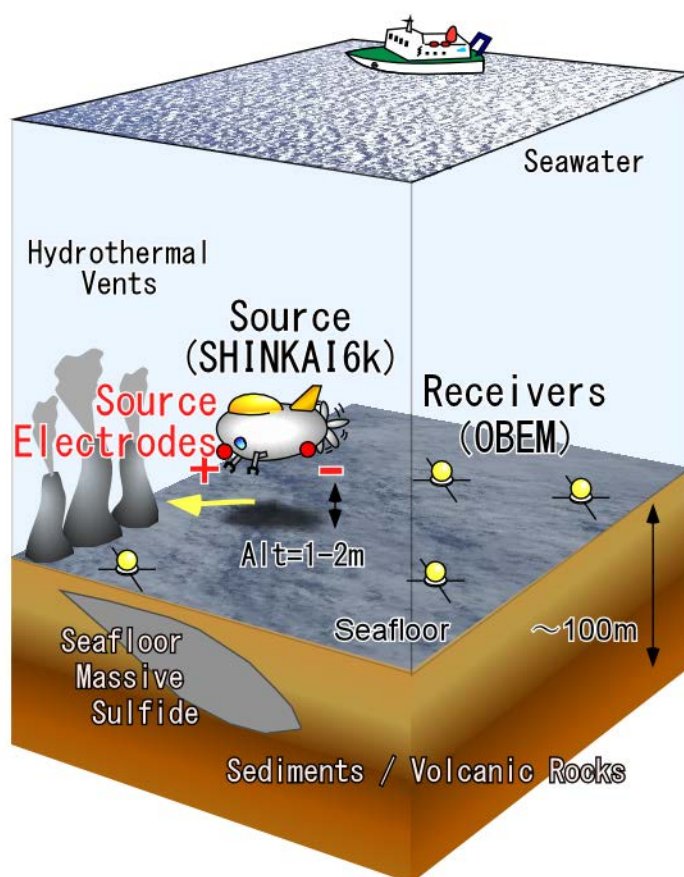

Fig. 4.1.1. Schematic drawing of submersible-based marine CSEM survey.

References

- Schwalenberg, K., Willoughby, E. C., Mir, R., and Edwards, R. N. (2005): Marine gas hydrate signatures in Cascadia and their correlation with seismic blank zones. *First Break*, 23, 57-63.
- Expedition 331 Scientists (2010): Deep hot biosphere. *IODP Prel. Rept.*, 331. doi:10.2204/iodp.pr.331.2010.

4.2. Geochemical Mapping

The purposes of the geochemical surveys using SHINKAI 6500 are, 1) to examine the feasibility of the observation strategy and survey operations focused on hydrothermal plumes using miniaturized multi-parameter in situ chemical sensors and analyzers, 2) to verify the methodology to discover new hydrothermal active sites using the real-time data from the pH sensors and Mn analyzer, 3) to conduct a high-resolution chemical sensing using a chemical sensor array mounted on SHINKAI 6500, and 4) to obtain seawater samples for detailed analysis using conventional syringe water samplers and a standalone 128-bottle water sampler. Research fields for this study are the Iheya-North knoll and the Irabu knoll in the Okinawa Trough area. Because active hydrothermal sites were widely known in the Iheya-Nourth knoll, here we conducted evaluation of the sensors, an in situ analyzer, and water samplers. The Irabu knoll with hydrothermal sites was discovered in 2000 (YK00-06 scientific cruise), and partially surveyed again in 2011 (NT11-17 scientific cruise). In this area, all of sensors and samplers were operated for further evaluations at a hydrothermal site on the western knoll and survey operation at the northern caldera-like landform.

5. Instruments and Operation Methods

5.1. Marine CSEM survey

We developed a submersible-based controlled-source electromagnetic (CSEM) survey system which can be applied to exploration of seafloor massive sulfide. It was originally developed for AUV, actually attached to the AUV “Urashima” at the YK11-11 cruise), and is also available for the submersible survey.

The layout of instruments attached to the SHINKAI 6k is summarized in Figs. 5.1.1-5.1.4. The power for transmitter is supplied from the SHINKAI 6k. We attached three source electrodes (ch0, 1 and 2) to the SHINKAI 6k. Two of them are used for transmitting the artificial electric current into the seawater: ch0-ch1 (as a horizontal dipole) or ch0-ch2 (as a vertical dipole). The dipole length is 7.7m for ch0-1, and 2.8m for ch0-2, respectively. The pulse width for artificial current was 2 seconds, and the amplitude of current was approximately 20-30 A. The dipole of ch0-1 and ch0-2 were used alternatively. The current shooting was done every minutes and the shot sequence was as follows:

- 1) Positive with dipole ch0-1 for 2 sec.
- 2) Zero for 2 sec.
- 3) Negative with dipole ch0-1 for 2sec.
- 4) Zero for 2sec.
- 5) Positive with dipole ch0-2 for 2 sec.
- 6) Zero for 2 sec.
- 7) Negative with dipole ch0-2 for 2sec.
- 8) Zero for 2sec.
- 9) Waiting for the next 00 seconds (for 28 sec.)

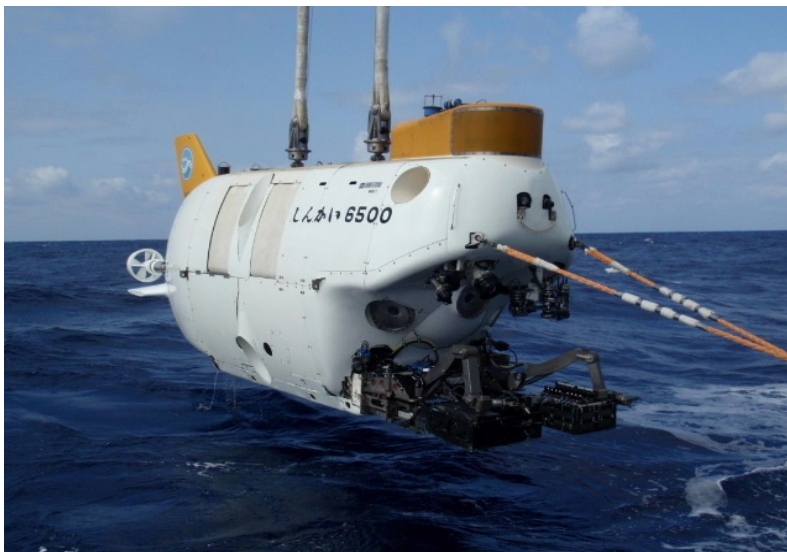

Fig. 5.1.1. SHINKAI 6k, dive #1297. The CSEM units were attached. The CSEM experiment was done on April 28 and 29.

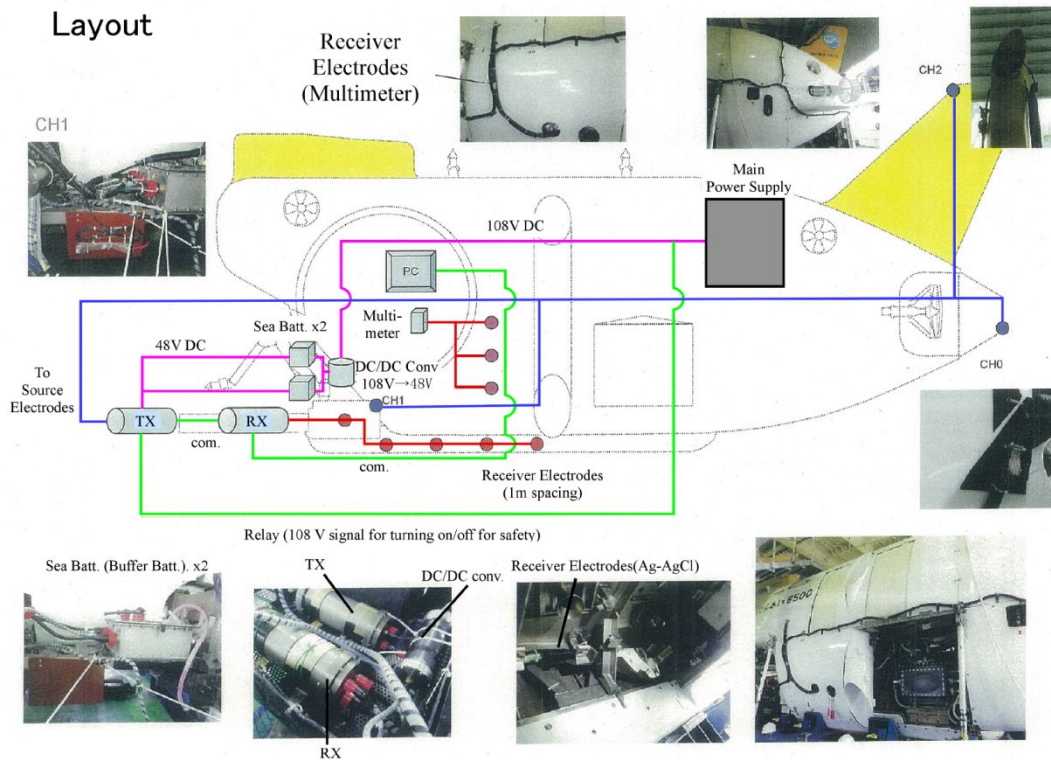

Fig. 5.1.2. Schematic view of SHINKAI 6k with CSEM units.

Tx: transmitter , RX: receiver and controller. Blue lines: for transmitting artificial electric current into the seawater. Red lines: for receiving the electric field.

Green lines: for communication/control of the instruments.

Purple lines: for power supply to the transmitter.

Circles: source or receiver electrodes.

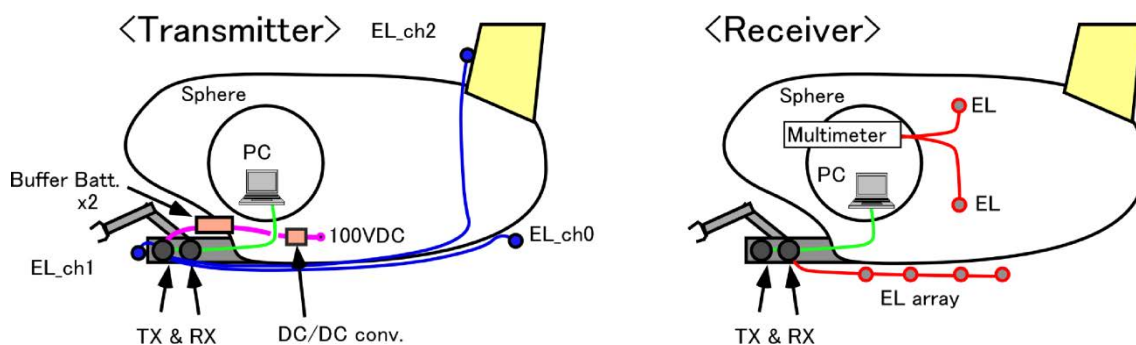
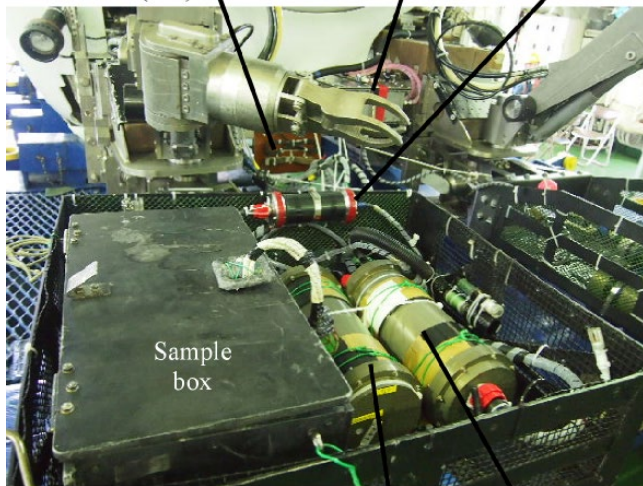

Fig. 5.1.3. Schematic view of transmitter system and receiver system, respectively.

EL: electrodes. Color of lines has the same meaning in Fig.5.1.1.



Source Electrode (ch1) Sea Batt. x2 DC/DC Conv



Sample box

RX TX

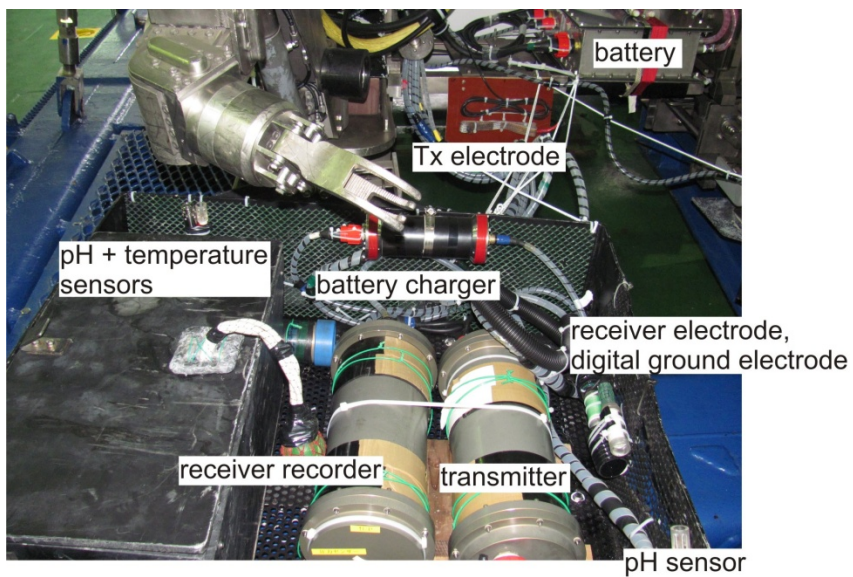

pH + temperature sensors

battery charger

receiver electrode, digital ground electrode

receiver recorder

transmitter

pH sensor

Fig. 5.1.4. Payload photographs at dive #1297 and #1298, SHINKAI 6k.

For this experiment, we deployed six OBEM/OBEs for receiver (Fig. 5.1.5). Although the receiver is attached to the SHINKAI 6k, it can be used for quite shallow resistivity survey below the seafloor because the source-receiver separation is less than 10m. For deeper exploration, the OBEMs and OBEs are necessary as far-side receivers. The OBEM (Fig.5.1.4) was a self pop-up type, developed in 2005. The OBE is a updated version for the deployment of rough seafloor topographic area. The sampling rate is 8Hz. The resolutions of magnetic and electric field are 0.01nT (for OBEM) and 0.01microV/m (for OBEM and OBE), respectively. The Ag-AgCl electrodes are attached at the tip of arm, having the dipole length of 4.44m for OBEM and 1m for OBE.



Fig. 5.1.5. Four OBEMs (ocean bottom electromagnetometers) and two OBEs (ocean bottom electrometers) before the deployment (April 27).

The OBEM system with a high sampling rate was designed to investigate the crustal and mantle structure (Fig. 5.1.6). It has a folding-arm system to facilitate assembly and recovery operations (Kasaya et al., 2006; Kasaya and Goto, 2009). Concepts of our developed OBEM and OBE system are miniaturization, a high sampling rate, easy assembly and recovery operations, and low costs of construction and operation. Figure 5.1.7 shows the schematic diagram of the arm-folding system. Electric circuit used for each system is contained in the pressure glass spheres. The fluxgate magnetometer of the OBEM system is mounted outside the glass sphere (Fig. 5.1.6). The salient

characteristic of our system is its arm-folding mechanism, which facilitates and simplifies our onboard operations. For measuring the electric field, we used Ag-AgCl electrode mounted at the toe of each electrode arm. We used an acoustic release system that had been already used by JAMSTEC for Ocean Bottom Seismography (OBS). Clock synchronization before deployment and calibration after recovery are important. This OBEM system can synchronize to the laptop PC using USB communication. To synchronize the laptop PC to GPS clock, we developed the NTP server unit.

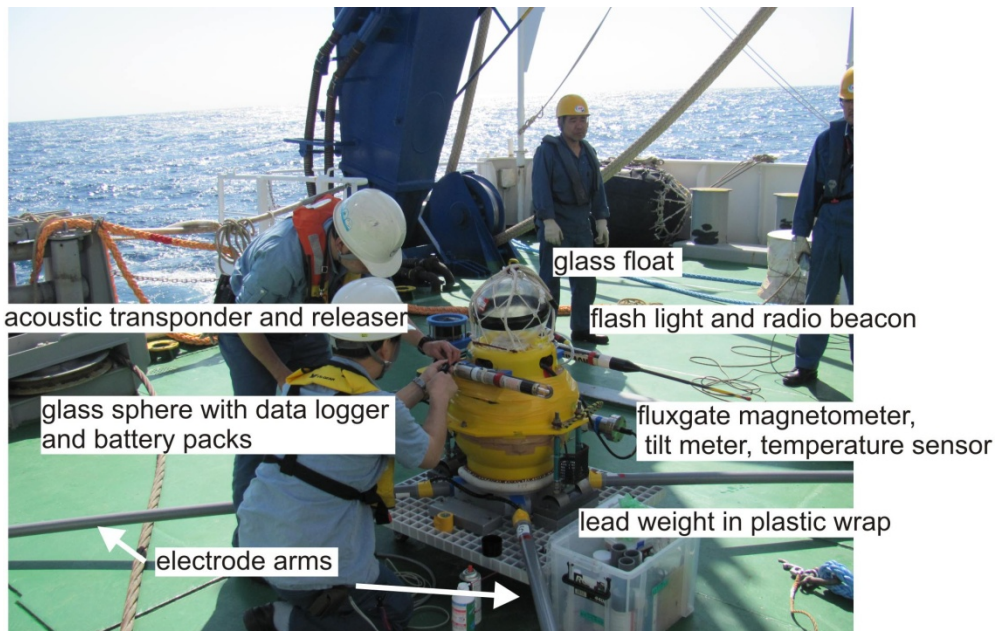
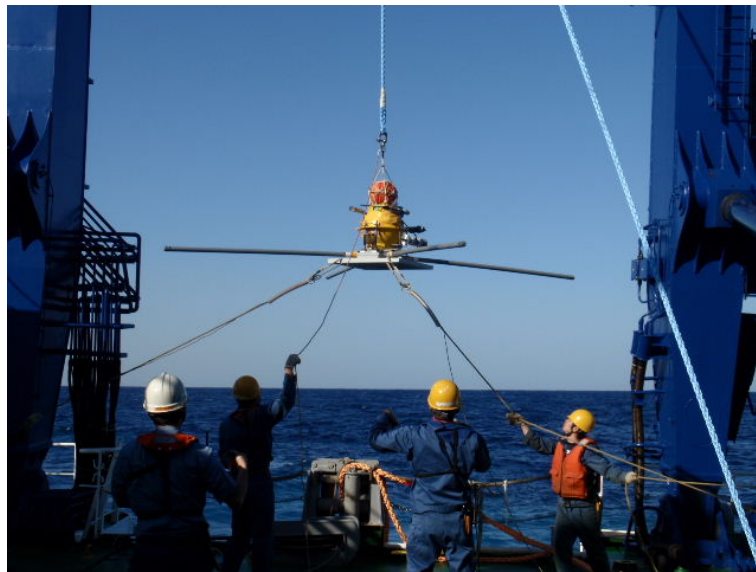

Fig.5.1.6. photographs at the deployment of OBEM.

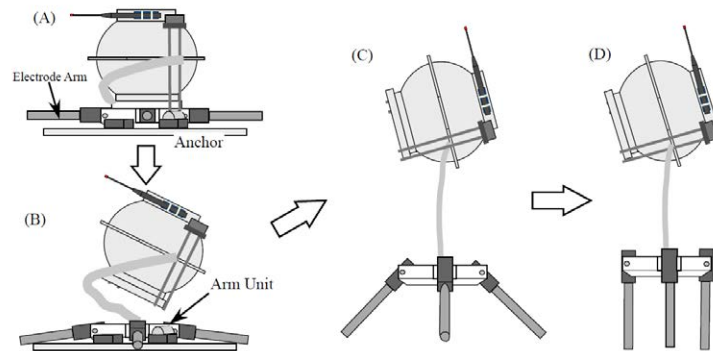

Fig. 5.1.7 Schematic diagram of the arm-folding system. After starting to pop up, the arm unit is picked up as the sphere ascends (Patent number of Japan: 4346605).

Other type OBEM is designed to deploy around the rough topographic area (Fig.5.1.8). The electric circuit, tilt meter and small fluxgate magnetometer are installed in an aluminum pressure case with the battery pack. Ag-AgCl electrodes mounted at the toe of each short electrode arm are also used for electric field measurement. A common electrode is mounted on the top of buys (Glass sphere). An acoustic release system is used same as former OBEM's releaser.

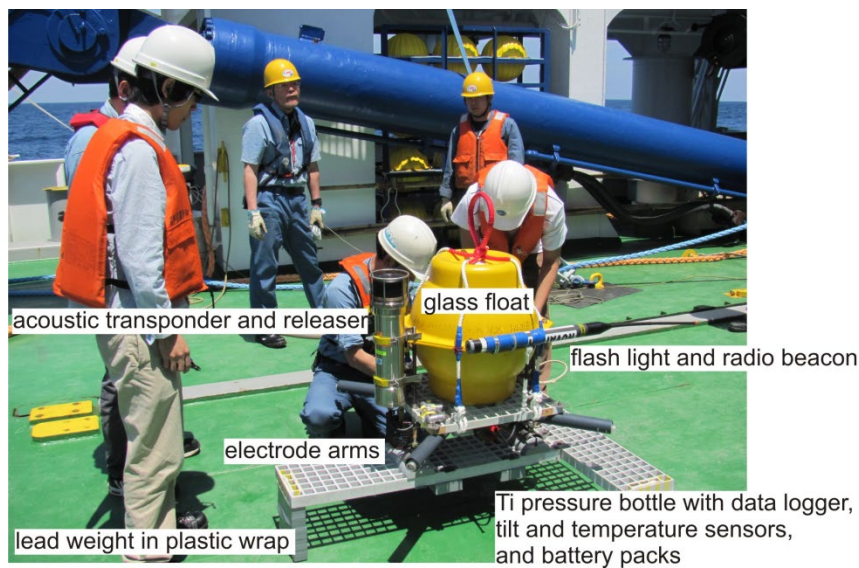

Fig. 5.1.8 New OBE system designed to deploy around the rough topographic area.

References

- Kasaya, T., T. Goto, and R. Takagi (2006), Marine electromagnetic observation technique and its development –For crustal structure survey-, *BUTSURI-TANSA*, *59*, 585-594 (in Japanese with English abstract).
- Kasaya, T. and T. Goto (2009), A small OBEM and OBE system with an arm folding mechanism , *Exploration Geophysics*, *40*, 41-48.

5.2 Geochemical sensors

5.2.1 Manganese ion quantitative determination using an IISA-Mn

Manganese ion (Mn^{2+}) in seawater can be utilized as a useful marker element for hydrothermal activity survey operations because of its specificity. The major and reliable method for a highly sensitive and quantitative determination of Mn^{2+} is an in situ FIA (flow injection analysis) or CFA (continuous flow analysis) utilizing a luminol based chemiluminescence reaction. We have developed an IISA (Integrated In Situ Analyzer) –Mn (Fig. 5.2.1) for the purpose of Mn^{2+} CFA for hydrothermal activity survey. The most important characteristic of IISA-Mn is utilization of a “microfluidic device” as its core analytical element. By applying the microfluidic device and a micro-pumping unit, a functionally integrated and highly miniaturized CFA apparatus was realized. In this cruise, IISA-Mn was mounted on the SHINKAI 6500 for dive 1299 to 1302 to evaluating the system and for the practical operations to detect Mn^{2+} concentration anomalies. The system was calibrated in situ using Mn^{2+} standard solutions (0.2 and 1.0 μM) before and after the survey operation. Chemiluminescence intensity data was monitored in real-time using a laptop PC and the data was recorded every 1 sec.

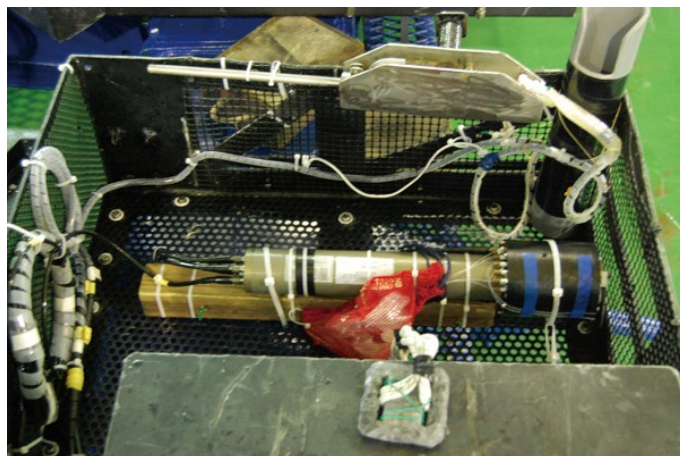

Fig. 5.2.1 IISA-Mn (Tokyo Univ.) mounted on a sample basket of SHINKAI 6500

5.2.2 pH, ORP, and H_2S sensing using an electrochemical sensor

In situ pH, ORP (Oxidation-Reduction Potential) measurement and H_2S quantitative determination were conducted using a series of electrochemical sensor (Kochi Univ. Fig. 5.2.2) mounted on SHINKAI 6500. pH can be measured using a modified glass electrode for deep-sea applications. ORP is measured using a Pt working electrode and a reference electrode. H_2S concentration is measured by a linear-sweep voltammetry using an Ag electrode. H_2S in surrounding water was concentrated on the Ag-electrode at -0.3 V v.s. an Ag/AgCl electrode for

10 seconds. Then, the concentrated H₂S was released by sweeping the voltage down to -1.3 V v.s. the Ag/AgCl electrode for 1 second. The electric current during the removal stage is correlated with the concentration of H₂S. H₂S concentration was calculated from the electric currents. The electric currents and the calculated H₂S concentration data were stored in a data logger inside a pressure housing. These chemical sensors were bundled with a commercially available compact CTD-T (Turbidity) profiler for practical operations.



Fig. 5.2.2 pH, ORP and H₂S sensor with CTD-T profiler mounted on SHINKAI 6500

5.2.3 pH measurement using ISFET pH sensors

ISFET (Ion-Sensitive Field-Effect Transistor) based pH sensors (Fig. 5.2.3) were used to detect low-pH anomalies in hydrothermal active areas. Three standalone pH sensors were mounted on SHINKAI 6500 for all dives. pH sensors were mounted at center (or top), left, and right front end of the SHINKAI 6500, respectively (Fig. 5.2.4) as a sensor array for the high-resolution chemical sensing. Distance between the left and right sensors is 1.8 m (approx. 0.9 m from the center sensor). When the central pH sensor is mounted at the top of the vehicle, the height from the bottom is 3.2 m. All of the pH sensors were calibrated onboard before and after the deployments using pH standard solutions (Amp, Tris). Standalone temperature recorders (Starmon mini, STAR ODDI, Iceland) were operated together with pH sensors mounted at left and right to monitor the temperature anomalies of the plume.

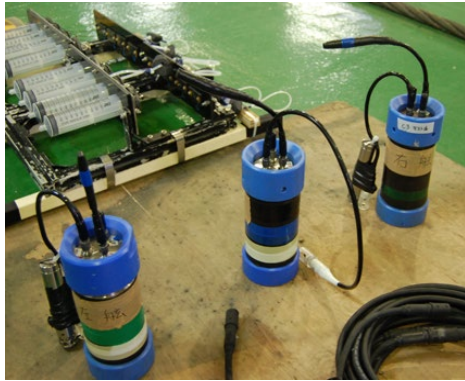

Fig. 5.2.3 ISFET pH sensors

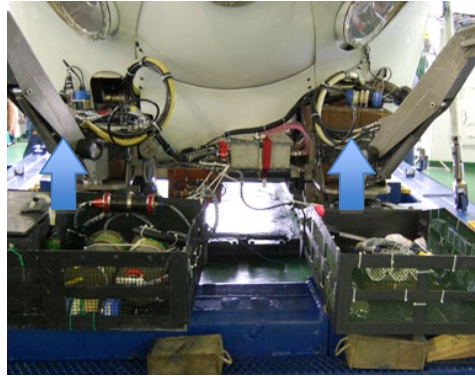

Fig. 5.2.4 pH sensors mounted on the vehicle

5.2.4 pH measurement using AMIS pH sensor

A pair of semiconductor chemical sensor, AMIS (Accumulation Method Ion Sensor), was used to detect pH anomalies. Because of signal accumulation function of the AMIS, it has higher sensitivity against pH change compare to conventional ISFET pH sensors. The AMIS sensor head has a pair of ion sensitive gate for differential measurement. Here, the AMIS sensors was integrated with a small pump unit to supply the seawater samples from left and right side of the SHINKAI 6500. Two sensor-pump systems are simultaneously operated during the 1299 dive, and one of the two systems was used for 1300 to 1302 dive. The system is connected to the vehicle for power supply and communication. The data can be monitored in real-time using a lap-top PC.



Fig. X5 AMIS pH sensor

5.2.5 Radioactivity mapping using a gamma rays sensor

The In-situ gamma rays sensor using a plastic scintillator was mounted horizontally on SHINKAI 6500 for all dives (Fig. 5.2.5). The gamma rays sensor consisted of the plastic

scintillator, photomultiplier tube, amplifier unit, high-voltage power supply, and data logger, and all parts were stored in a pressure case. The sensor was connected to the vehicle for power supply.



Fig. 5.2.6 Gamma rays sensor

5.2.6 Water sampling

A series of water samples was collected during the dive 1299 to 1302 using the syringe water samplers (Fig. 5.2.7) and the standalone 128-bottle water sampler (Fig. 5.2.8). The syringe water samplers can collect 8 bottles of 100 ml seawater in plastic syringe using a manipulator of SHINKAI 6500. The standalone water sampler can automatically collect 128 series of 40 ml seawater samples in every 10 min during the dive. Collected water samples were analyzed onboard on its pH and TIC (Total Inorganic Carbon) contents, and parts of the samples were stored 4 °C for Mn concentration analysis afterwards.

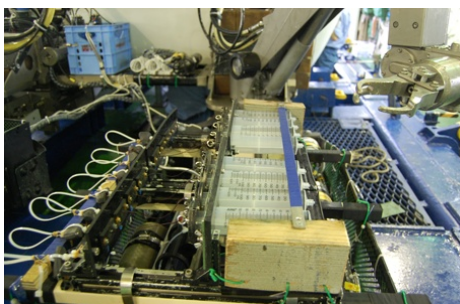

Fig. 5.2.7 Syringe water sampler

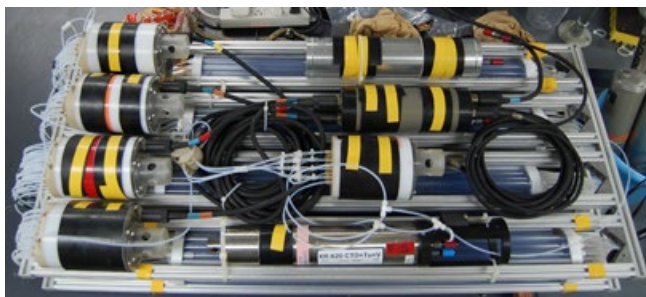

Fig. 5.2.8 Standalone 128-bottle water sampler

5.2.7 Onboard chemical analysis

pH of seawater samples were measured onboard using a desktop apparatus to confirm the in situ pH measurement results. TIC contents of the seawater samples were also measured onboard using acid extraction method.

6. Preliminary Results

6.1. Marine CSEM survey

The SHINKAI 6k dives #1297 and #1298 were carried out on April 28-29. The water depth is about 950-1100m. Figs. 6.1.1-6.1.3 indicate the site map and tow profiles with bathymetry. The major three profile has its each length of about 1000m, and the profile spacing is about 150m. The SHINKAI 6k can keep the altitude of 0.5-2m along the profiles, except for the hydrothermal vents. The cruising speed of SHINKAI 6k was about 1 knots or less. During the cruise on profiles, the SHINKAI 6k sent the artificial signal with every 1 minute, so that the spacing of source points was about 30m. The waveform of source signal was squared one with 2-sec pulse width, and the period was about 8 sec. Here, we report the preliminary results especially the first look of the observed data.

At the first dive, #1297 (observer: Takafumi Kasaya, on April 28), we successfully shoot the electrical current from the SHINKAI 6k. However, the DC/DC converter, used as the battery charger for sea battery during the dive, had trouble at the previous dive and could not supply the electric power to the sea battery. As a result, the current amplitude became small at later half of the dive.

The next dive of SHINKAI 6k, # 1298 was also carried out (observer: Tada-nori Goto, on April 29). Since the trouble of DC/DC converter, we conducted the rock sampling at several stations at this second dive. During the sampling, we continuously sent the artificial electric current at these stations. This allows us the stacking of the received electric signals at OBEMs and OBEs, and will result in the precise signal detection although the source amplitude was limited at this dive.

Before and After the CSEM experiment, OBEMs/OBEs were successfully deployed (on April 27) and recovered (April 29-May 1, before and after the dive of SHINKAI 6k). They recorded the signal from the SHINKAI 6k. Fig. 6.1.4 indicates the received electric field by OBEM 4. In this case, the maximum amplitude of source current from the SHINKAI 6k was about 28A (+/-56A), and the maximum received amplitude was about $50 \mu \text{V/m}$.

Based on the amplitude ratio between source current and received electric field, we roughly estimate the apparent resistivity (averaged resistivity of both seawater and seafloor). Now we simply assume the DC assumption, so that the apparent resistivity can be estimated easily following a manner of DC resistivity survey. Fig. 6.1.5 indicates the source and receiver positions for estimation of apparent resistivity. Fig. 6.1.6 indicates the distribution of apparent resistivity. In this preliminary result, we found that the apparent resistivity widely change place to place. It suggests a spatial heterogeneity of resistivity structure together with a vertical variation of the structure. In near future, we will use the observed data for the inversion of three-dimensional resistivity structure below the survey area. The obtained

resistivity distribution should be useful for discussion of the circulation of hydrothermal fluid below the Iheya north knoll, and also for the evaluation of hydrothermal deposits such as massive sulfide.

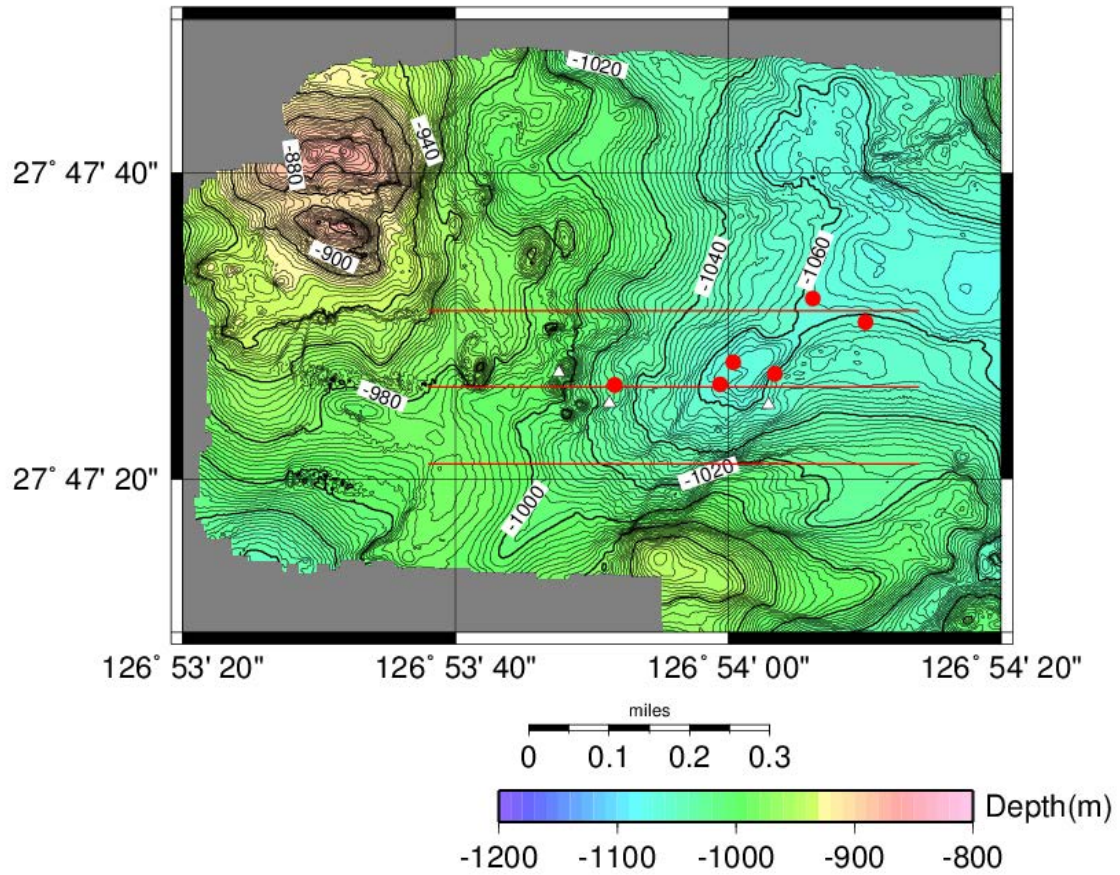
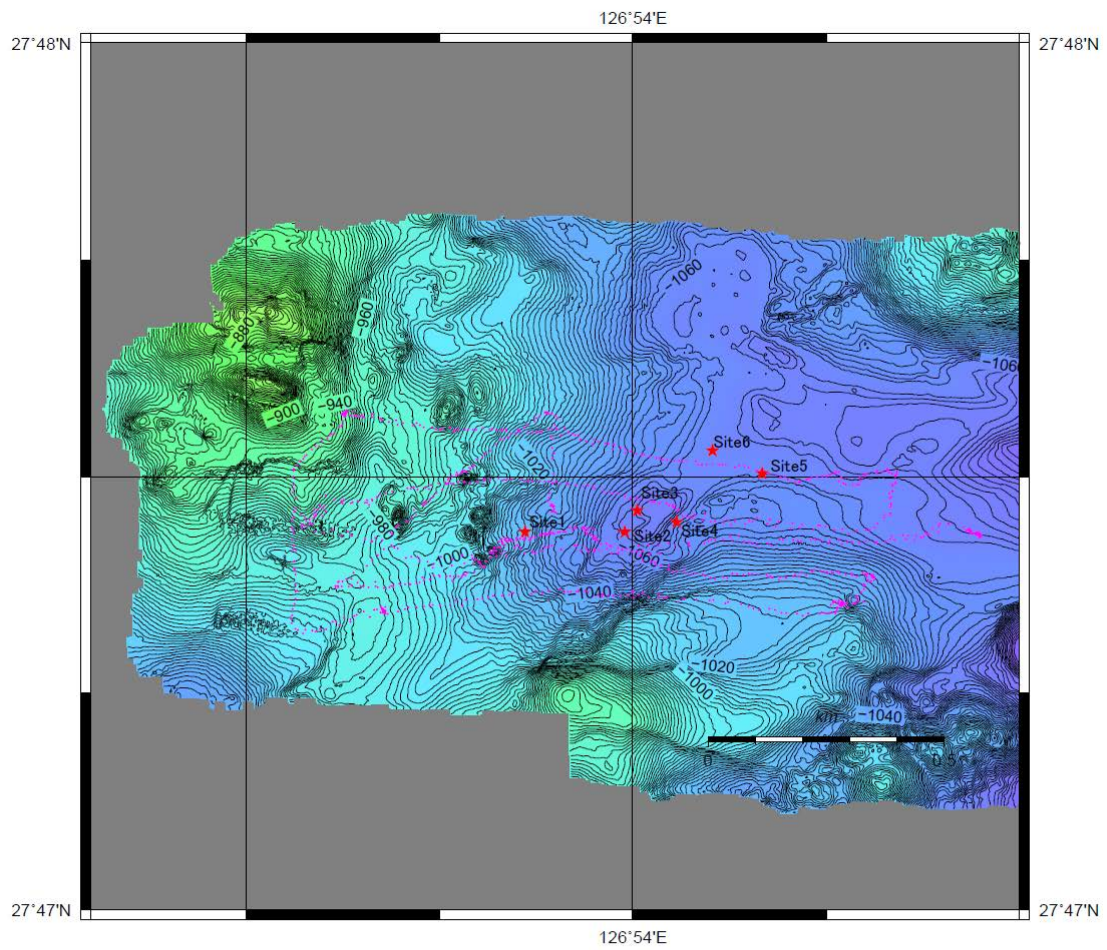

Fig. 6.1.1 Site map with planned cruise profiles of SHINKAI 6k. Red circles: landing points of OBEMs (right three of them) and OBEs (left two of them). Red lines show the planned survey lines of SHINKAI 6k. Triangles: drilling site by D/V Chikyu.

YK12-05 6K #1297 Dive Track at Iheya



2012 May 01 08:34:14 Map_scale=Bathymetrics data,YK07-07 Leg2_Seabat7125,cont_int=2,anot_int=20

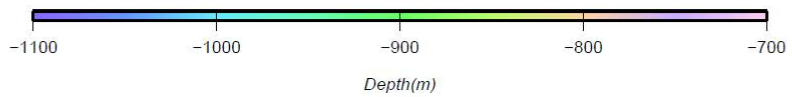
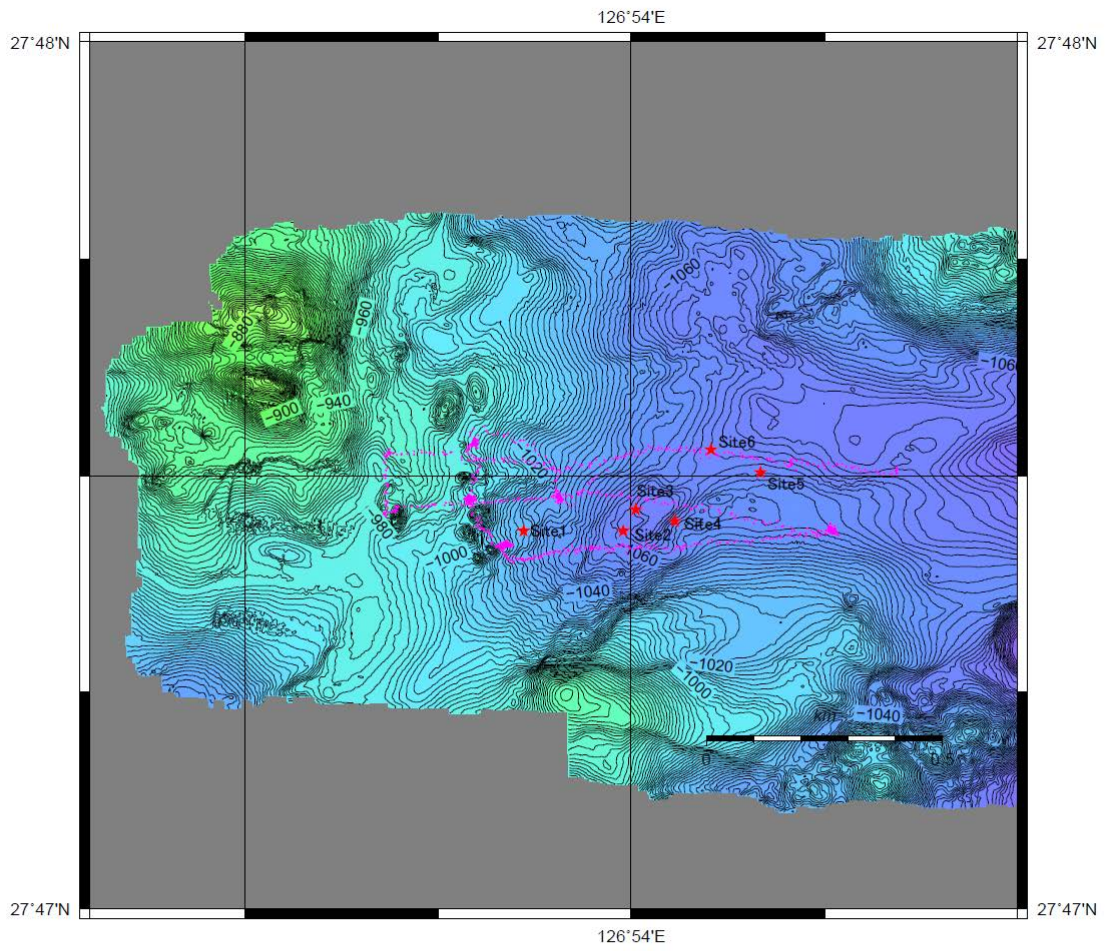

Figure 6.1.2 Actual cruise profile of SHINKAI 6k at the dive #1297.

YK12-05 6K Dive #1298 Track at Iheya



GMD 2012 May 01 09:26:53 Map_scale=Bathymetrics data,YK07-07 Leg2_Seabat7125.cont_int=2,anot_int=20

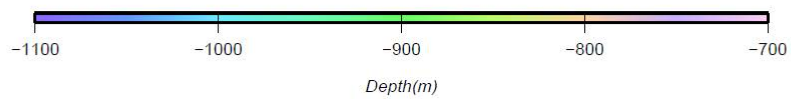

Figure 6.1.3 Actual cruise profile of SHINKAI 6k at the dive #1298.

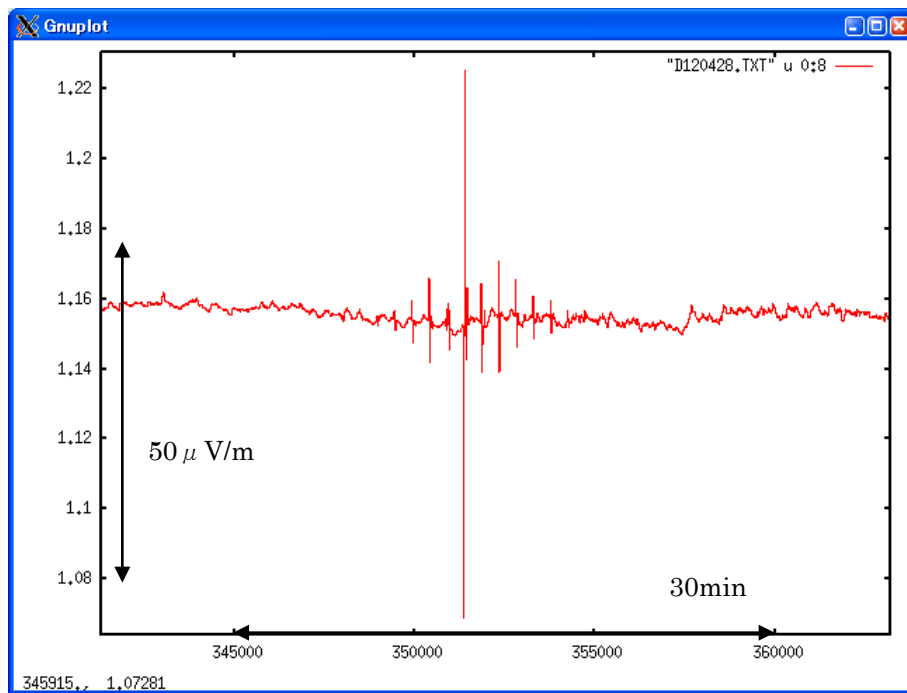

Fig. 6.1.4. Example of received electric field. The SHINKAI 6k moved with about 1knot, so that the electric field can be recognized by eye at least with the source-receiver distance of 300m. After the quantitative analysis, the distance will be extended to 600m or more.

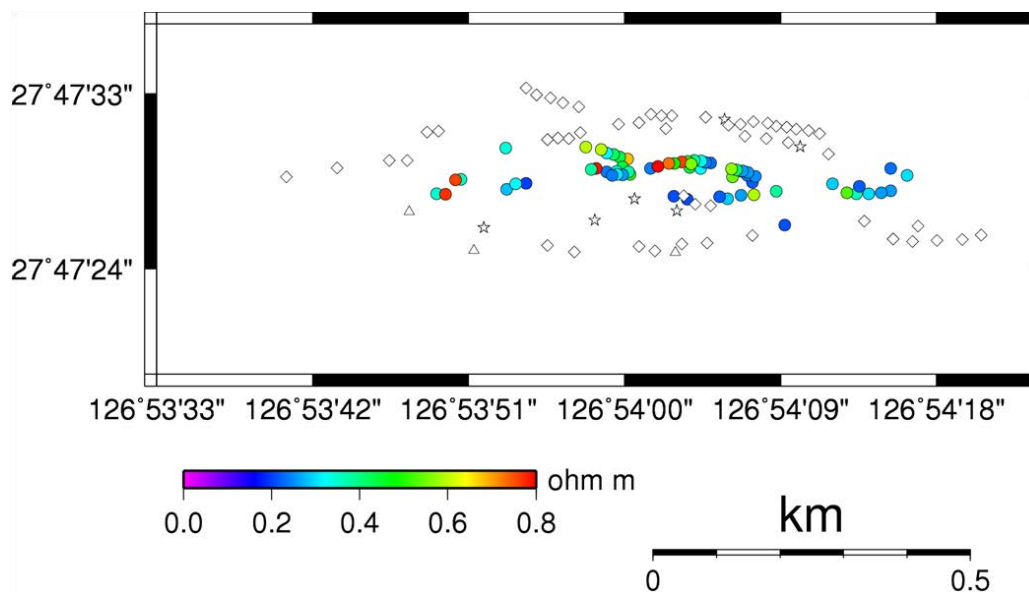

Fig. 6.1.5. Distribution of apparent resistivity obtained by the marine CSEM survey. Stars: OBEM and OBE sites. Diamonds: the source location. Triangle: Drilling site. Circles: Apparent resistivity plotted at the mid-point between the source and receiver. This is a quite preliminary result based on the initial analysis

using a part of the whole observed data.

6.2. Geochemical sensors

Totally 4 dives planned for the sensor evaluation and geochemical surveys were successfully performed. A photo of SHINKAI 6500 with chemical sensors, in situ analyzers, and water samplers is shown in Fig. 6.2.1. Dive track for the dive 1299 to 1302 are shown in Fig. 6.2.2 to 6.2.5.

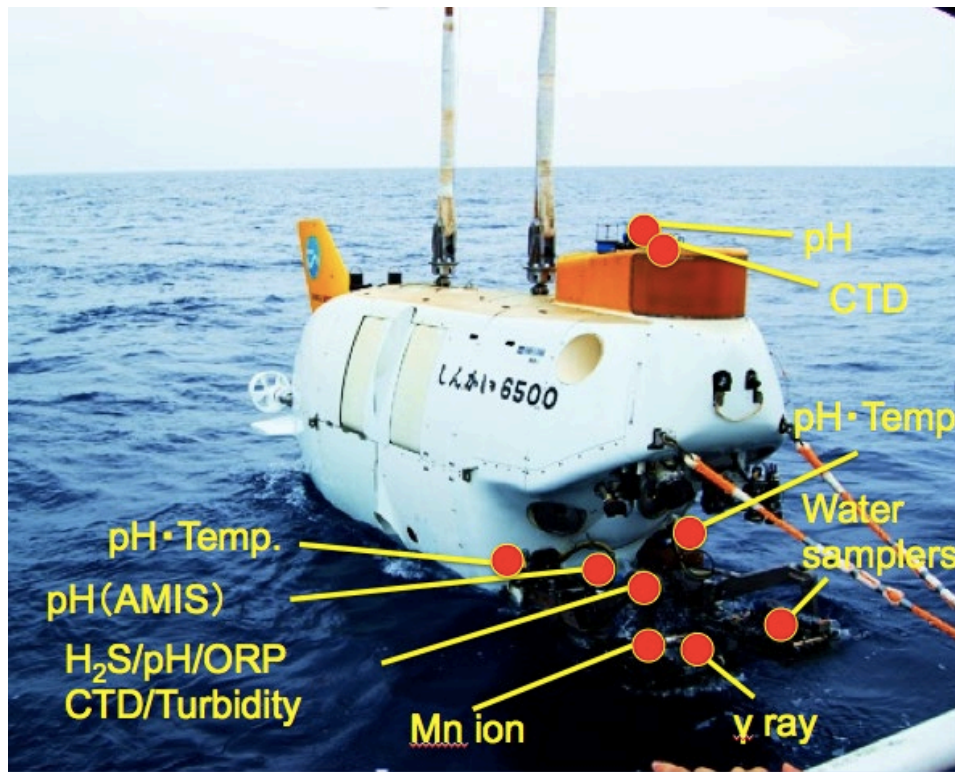

Fig. 6.2.1 SHINKAI 6500 with payload apparatus (dive 1302)

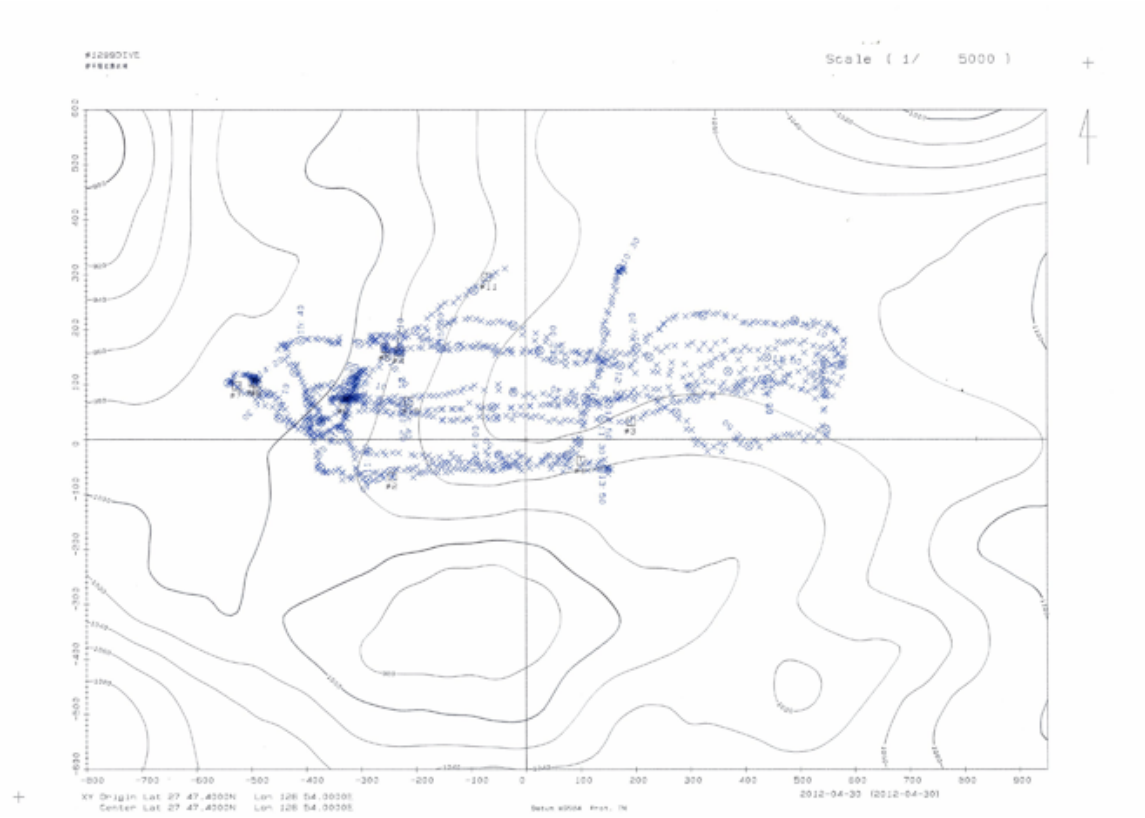

Fig. 6.2.2 SHINKAI 6500 dive 1299 track at the Iheya-North knoll

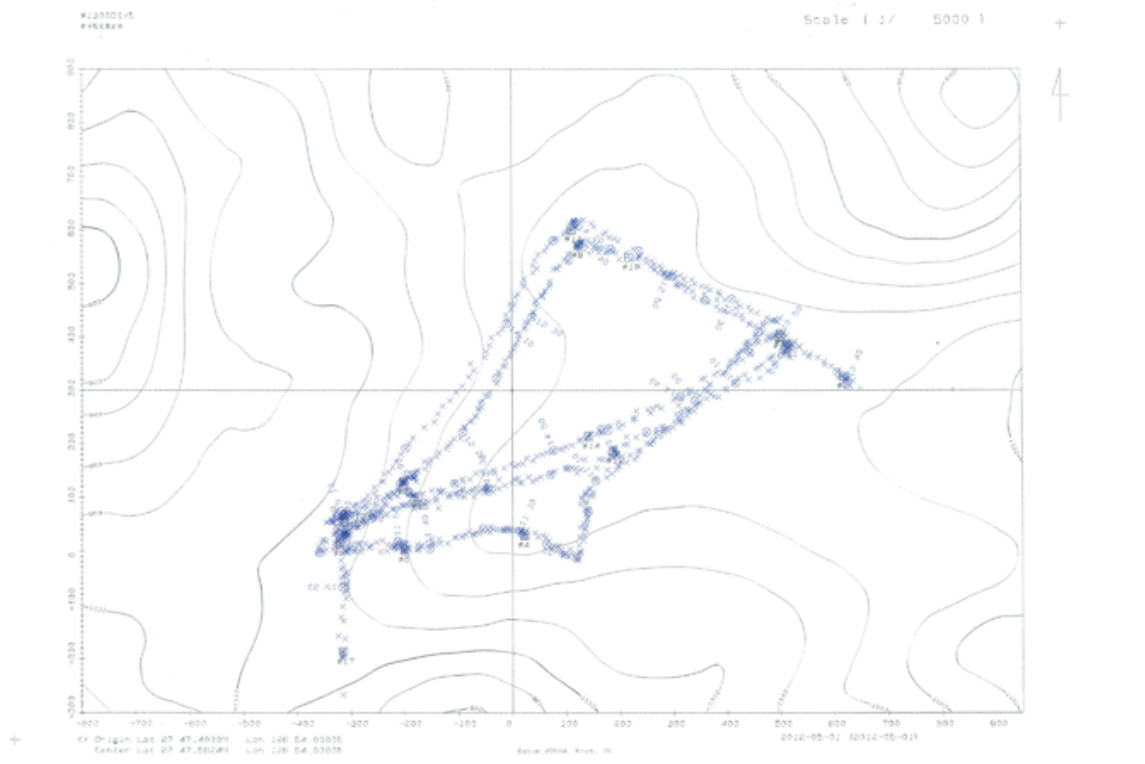

Fig. 6.2.3 SHINKAI 6500 dive 1300 track at the Iheya-North knoll

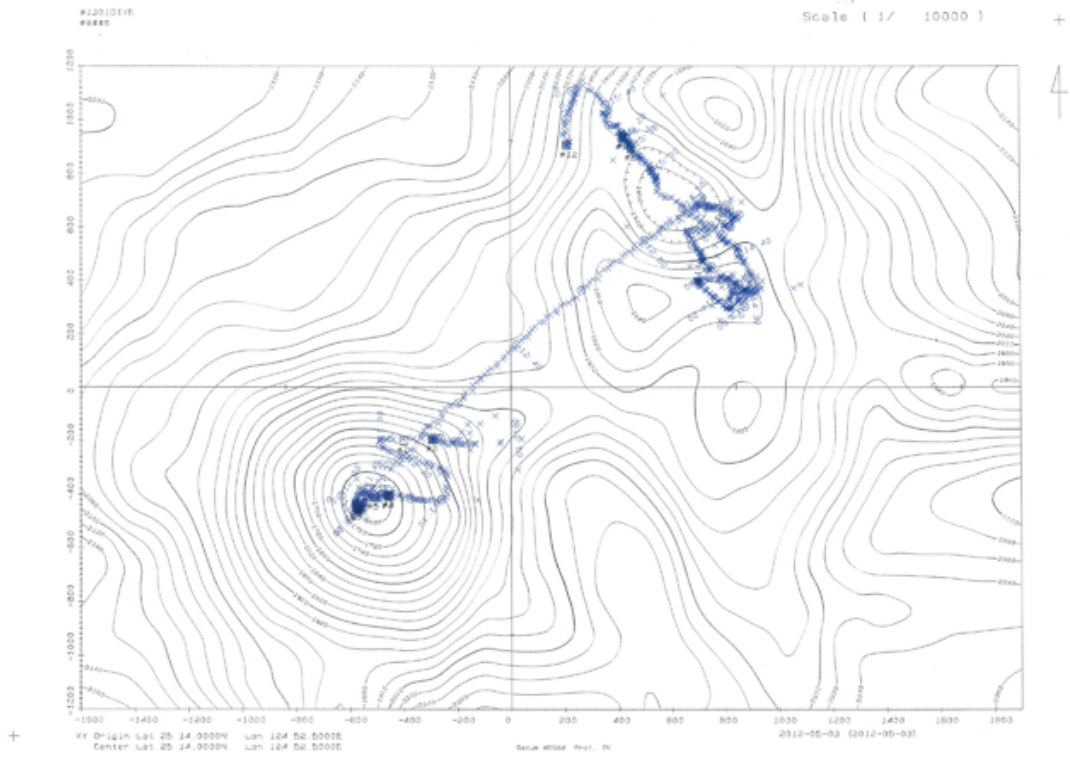

Fig. 6.2.4 SHINKAI 6500 dive 1301 track at the Irabu knoll

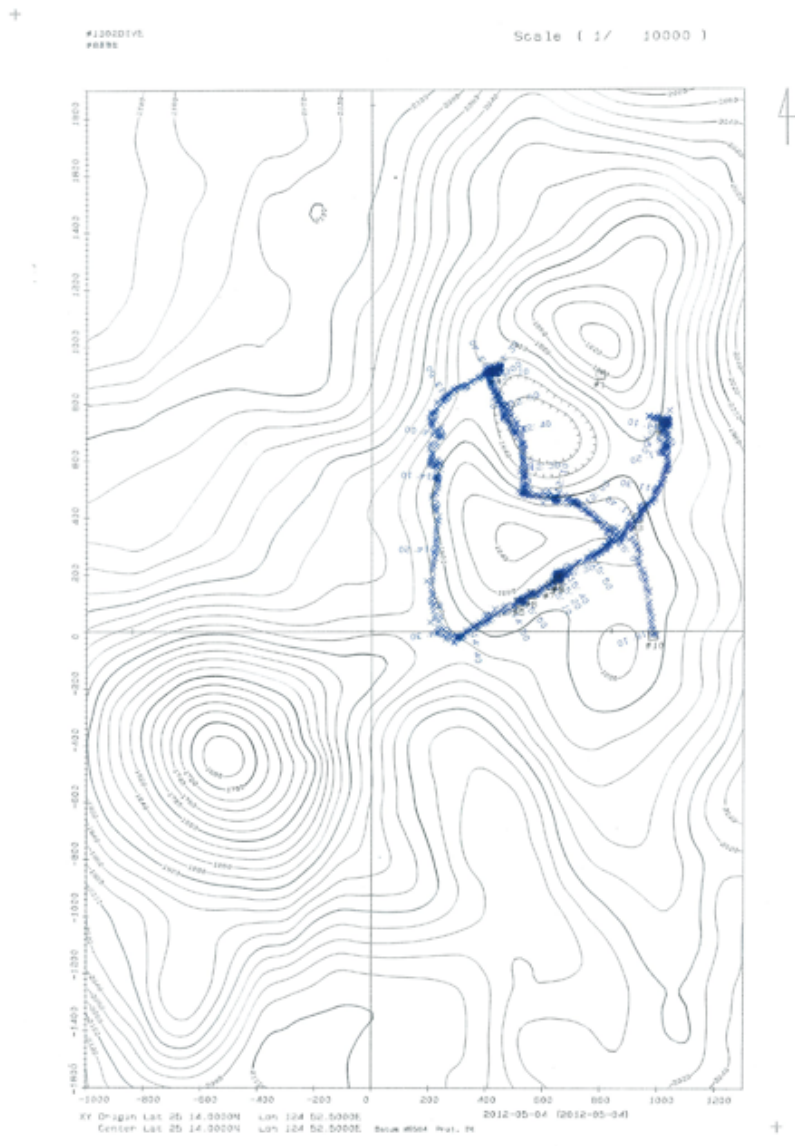

Fig. 6.2.5 SHINKAI 6500 dive 1302 track at the Iribu knoll

IISA-Mn was mounted on SHINKAI 6500 for dive 1299 to 1302. As a result, IISA-Mn could obtain positive chemiluminescence peaks (corresponds to Mn concentration anomalies) when SHINKAI 6500 approached to hydrothermal plumes or hydrothermal active sites during the dive 1299, 1301, and 1302. For the dive 1300, the IISA-Mn had a problem on its pump and was not operated.

In situ chemical sensors for pH, ORP, and H₂S quantitative determination was mounted on the SHINKAI 6500 for all dives of this cruise (dive 1298 to 1303). As a result, all parameter had shown clear anomalies when SHINKAI 6500 approached to hydrothermal active areas. Vertical profiles from the sea surface to the bottom were also obtained during all dives. Some vertical

profiles indicate that there are several hydrothermal plumes that have distinct chemical anomalies in the Irabu knoll area. These plumes may be coming from unknown hydrothermal sources.

Most of the ISFET pH sensors worked successfully for all dives and apparent low-pH anomalies were detected at the Iheya North knoll and the Irabu knoll as same as the other chemical sensors. When SHINKAI 6500 approached to or landed on the hydrothermal active sites at the Iheya-North and Irabu knoll, three pH sensors mounted on the left, right and center (top) of the vehicle shown lower pH compare to surrounding water and their value shows clear difference each other. It may be caused by a local non-uniformity of distribution of hydrothermal fluid. By analyzing the data in detail, distribution and behavior of hydrothermal plumes on its initial phase of its spreading will be elucidated.

AMIS pH sensor systems that operated during the dive 1299 to 1302 also showed same tendency with the ISFET pH sensor. The data from AMIS pH sensor system was continuously monitored during the SHINKAI 6500 operation in real-time to detect the hydrothermal plumes. pH value showed clear anomaly when IISA-Mn showed positive signal (Mn anomaly).

Gamma rays sensor was successfully operated during all dives of this cruise. The data will be processed soon to visualize the gamma ray anomalies caused by hydrothermal plumes and deposits on the seafloor.

Series of seawater samples (including plume water) were collected using syringe water samplers. 8 samples were obtained in maximum for each dive. The collected water samples will be used to determine Mn concentration to compare with in situ results that were obtained by using the IISA-Mn. Seawater samples were successfully collected using the standalone 128-bottle water sampler during the dive 1300 to 1302. We conducted the pH and TIC analysis for fluid samples onboard. pH were determined by the colorimetric titration with meta-cresol purple, and TIC measurement were using a non-dispersive infra-red (NDIR) gas analyzer with phosphoric acid extraction.

As a result of the survey operation at the Irabu knoll, two hydrothermal sites accompanied by hydrothermal biota were found. A northern site with weak (or not visible) fluid seepage (Fig. 6.2.6) that was found during the dive 1301 had not been previously reported. A location of southern site with visible clear fluid disruption (Fig. 6.2.7) that was found during the dive 1302 is near from the site reported previously (SHINKAI 6500 dive 562 and 567, YK00-06 cruise, 2000). However, their identity must be studied well with detailed survey operation of this area in future.



Fig. 6.2.6 Photo of the northern site with hydrothermal biota (bivalves, crustaceans)



Fig. 6.2.7 Photo of the southern site with hydrothermal biota (barnacles). Clear fluid eruption was observed.

7. Acknowledgements

The researchers thank the captain, crews and technicians of R/V Yokosuka, and operators of the submersible “SHINKAI 6500”. This project is supported by the Ministry of Education, Culture, Sports, Science & Technology in Japan.